

MEGA **LITE**

TUFF BABY P-84



USER MANUAL

Table of Contents

Safety Information.....	3
Specifications.....	4
Main Power Connection.....	5
DMX-512 Connection.....	5
Main Control Menu.....	6
DMX Profile.....	9
Rigging the Fixture.....	10
Cleaning & Maintenance.....	10
Parts List.....	10

Check that the unit has not been damaged during transport



Read all cautions and warnings
prior to operation of this
equipment

Protection Against Fire



1. Maintain a minimum of 1 foot distance from any type of flame.
3. Replace fuse only with the specified type and rating.
4. Do Not install the unit too close to a heat source.
5. Make sure cables are properly secured
6. Maximum surface operating temperature 140°.

Protection Against Electrical Fire

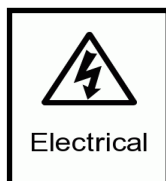

1. Disconnect power before servicing.
2. For connection to main power supply proceed to page 5.
3. This unit must be earthed. (electronically grounded)
4. This fixture must not be left on for long periods of time.

Protection Against Mechanical Hazards



1. Use safety chain when hanging unit.
2. Use quality clamps or bolts when positioning unit
3. Do not open unit while it is on, risk of electrical shock.

Ingress Protection



The IP rating is commonly expressed as **IP (Ingress Protection)** is followed by 2 numbers (i.e. 65) where the numbers define the fixture rating. The first number indicates the size of a particle that can enter the fixture.. The second number indicates the extent of protection against water entering the fixture. An IP65 rating in this fixture indicates that dust particles can not enter the fixture. And there is protection against powerful water spray from entering the fixture from any direction.

Safety Standards



1. This Product conforms to USA and Canada ETL Safety Standards. And has been tested for Stage Lighting Safety Standards UL 1573

Technical Information

Part Numbers

4100- Tuff Baby P84

Mechanical Specifications

DMX Connectors: Weather 3 pin XLR connectors in and out
Thermal: Maximum ambient temperature 104°
 Maximum surface temperature 140°
Fastening System: Double Mounting Yoke
Display: Digital
Power connection: Weather Seal Screw type
Ip Rating: Ip 65

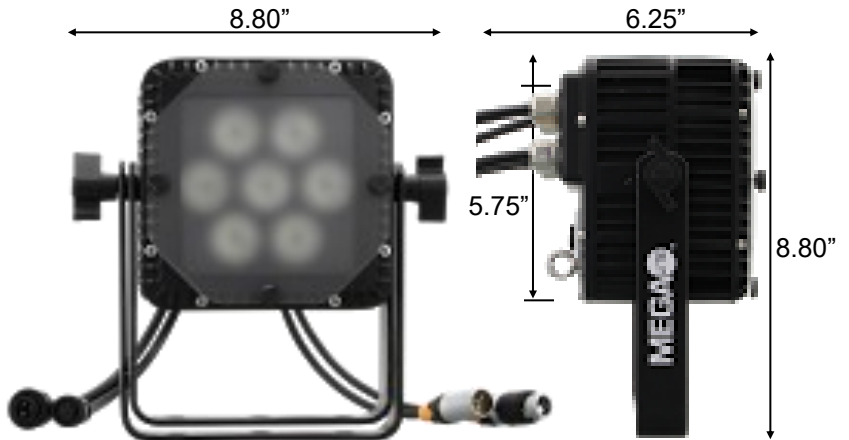

Fixture	Packaged
Size: 8.80" x 6.26" x 8.80"	Size: 10.25" x 10.25" x 11.5"
Weight: 6.4lb	Weight: 7.4lb

Electrical Specifications

LED Quantity: 7	LED Angle: 25°
Red: 7	Diffusion Beam Angel: 30°
Green: 7	Power Input Voltage: 110V-240 50/60 Hz
Blue: 7	Ballast: Electronic auto switching
White: 7	Power Consumption Watts: 56
Amber: 7	Amps: .84
LED Watts: 12	
LED Lifetime: 60 to 100 thousand hours Average	

Control & Programming

DMX 512 Protocol

DMX Modes: Mode 1 3 Channels Red, Green, Blue
 Mode 2 6 Channels Dimmer, Red, Green, Blue, White, Amber
 Mode 3 8 Channels Dimmer, Red, Green, Blue, White, Amber, Strobe, Macro

Control Options: Master Slave





Main Power Connection

Caution!

1. Do not connect fixture to a dimmer system.
2. This unit has Auto switching power supply. It will respond to 110V or 220V automatically
3. This unit must be earthed. (electronically grounded)
4. Replace fuse only with the specified type and rating.

The occupation of the connection-cable is as follows:

This fixture is equipped with an electronic power supply that will let the unit operate from 90V to 240V from 50Hz to

Cable (USA)	Cable (EU)	Pin	110V	220V
Black	Brown	Live	L	L
White	Light Blue	Neutral	N	L
Green	Yellow/Green	Ground		

110V
Connection

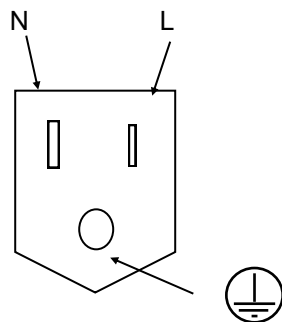

220V
Connection

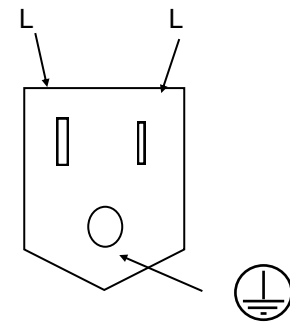

DMX-512 Connection

The fixture is equipped with 3 pin XLR Sockets for DMX input and output. The sockets are wired in parallel. Only use a shielded twisted pair cable designed for RS-485 and 3 pin outdoor XLR plugs and connectors in order to connect the controller with the fixture or the fixture with another.

DMX—input

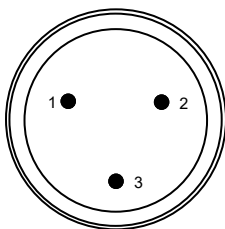

1. Shield
2. Signal (-)
3. Signal (+)

DMX—output

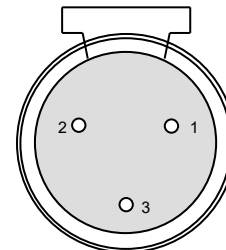

Caution!

At the last fixture the DMX signal needs to be terminated with a terminator. Solder a 120 Ohm resistor between the (-) and the (+) signal into a 3 pin XLR plug and plug it in to the last fixture on the signal run. Pre-manufactured terminator plugs are available.

Display Menu

CONTROL BOARD

The control board on the fixture base is your interface to access and control all the functions on the unit. Its digital display gives you a code view of the options and functions. The following will explain each function and its options.

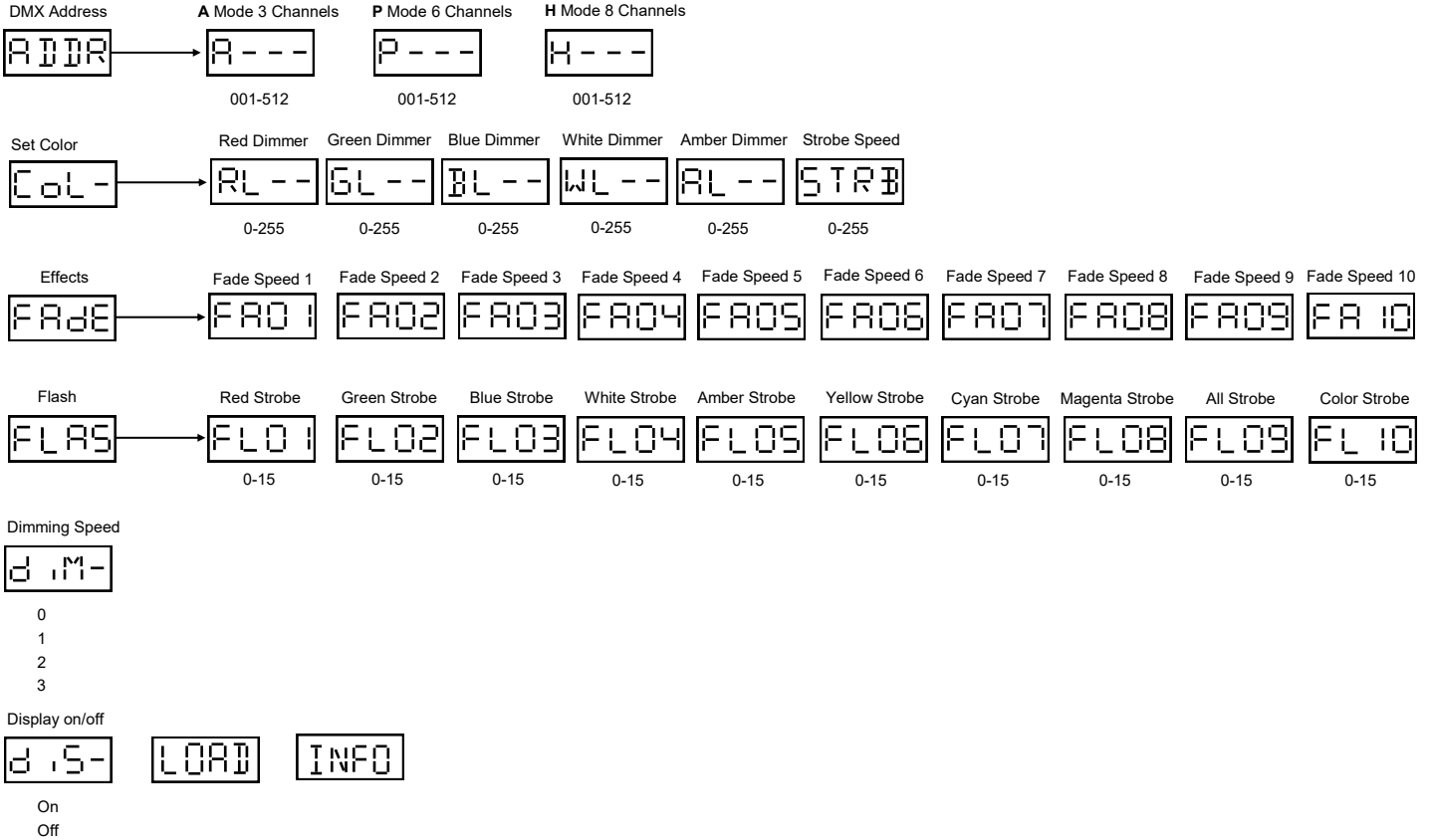
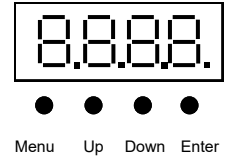

ADDR DMX Address

Press **Enter** to select the DMX start address channel. The first display will let you know what operation mode you are in. Use the **up/down** keys to select the desired mode. Press **Enter** to confirm. (first Letter will also change depending on what mode you are in) Use the **up/down** keys to select the desired start address press **Enter** to confirm

COL- Set Color Menu

Press **Enter** to set a color via display control. Use the **up/down** keys to select the desired color you would like to adjust. Press **Enter** to confirm. Use the **up/down** keys to select the desired intensity of the color. Press **Enter** to confirm.

FADE **Fade**

This function allows you to select a preprogrammed fade sequences. Press **Enter** use the **up/down** keys to select desired fade program (15 options). Press **Enter** to set the desired speed use the **up/down** keys (15 options). Press **Enter** to confirm the settings.

FLASH **Flash**

This function allows you to select a preprogrammed strobe sequences. Press **Enter** use the **up/down** keys to select desired strobe program (15 options). Press **Enter** to set the desired speed use the **up/down** keys (15 options). Press **Enter** to confirm the settings.

DM - **Dimming Speed**

Press **Enter** to select the desired dimming speed when used with a DMX controller. Use the **up/down** keys to select from 0 to 3. 0 speed will be the fastest 4 will be the slowest. Press **Enter** to confirm.

DS - **Display Setting**

Press **Enter** to select the desired display setting. Use the **up/down** keys to select from **On** for the display to stay on or **Off** for the display to turn off after 30 sec of no use. Press **Enter** to confirm.

INFO **Info**

Software Version Information

LOAD **Load**

Manufactures Software update function (manufacture personnel only)

DMX Indicator

CONTROL BOARD



When DMX Signal is being received the last point on the control board display will flash. If there is no DMX signal present it will be off.



Menu Up Down Enter

DMX Profile

Tuff Baby P84 Mode A

DMX Chanel	Function	Description	Value
1	LED Color	Red LED intensity	0-255
2	LED Color	Green LED Intensity	0-255
3	LED Color	Blue LED Intensity	0-255

Tuff Baby P84 Mode P

DMX Chanel	Function	Description	Value
1	Dimmer	Dimmer Off to Full	0-255
2	LED Color	Red LED intensity	0-255
3	LED Color	Green LED Intensity	0-255
4	LED Color	Blue LED Intensity	0-255
5	LED Color	White LED Intensity	0-255
6	LED Color	Amber LED Intensity	0-255

Tuff Baby P84 Mode H

DMX Chanel	Function	Description	Value
1	Dimmer	Dimmer Off to Full	0-255
2	LED Color	Red LED intensity	0-255
3	LED Color	Green LED Intensity	0-255
4	LED Color	Blue LED Intensity	0-255
5	LED Color	White LED Intensity	0-255
6	LED Color	Amber LED Intensity	0-255
7	Strobe	Strobe (slow to fast)	0-196
		Random Strobe (slow to fast)	197-255
		No Function	0-1
		Color fade All (slow to fast)	2-19
		Color Snap All (slow to fast)	20-39
		Random Color Snap (slow to fast)	40-59
		Red fade (slow to fast)	60-79
		Green fade (slow to fast)	80-99
		Blue fade (slow to fast)	100-119
		White fade (slow to fast)	120-139
		Amber fade (slow to fast)	140-159
		Macro Effect 1	160-179
		Macro Effect 2	180-199
		Macro Effect 3	200-219
		Macro Effect 4	220-229
		Macro Effect 5	230-249
		Macro Effect 6	250-255

Rigging the fixture

Caution!

1. The installations must be carried out by an authorized dealer or trained professional.
2. Unit may cause severe injuries if you have doubts concerning the safety do not install.

When rigging a unit it is very important that you follow common safety procedures. Rigging requires extensive experience including but not limited to calculating working loads, material being used and periodic safety inspections. If you lack these qualifications, do not attempt the installation yourself, instead use a professional structural rigger.

When rigging the unit always be secured with a secondary safety attachment. The installation location of the fixture has got to be built in the way that it can hold 10 times the weight for 1 hour with out any harming. Installation should be checked at least one time a year by a skilled person.

Cleaning and maintenance

Installation Maintenance: The operator has to make sure that the unit is operating safely and has the installations and electronics checked by an expert every 2 years.

The following points have to be considered during the inspection:

- 1) All screws used for installing the device or part of the device have to be tightly connected and must not be corroded.
- 2) There must not be any deformations on the housing, fixation and installation spots (ceiling, suspension, trussing).
- 3) The electronic power supply cables must not show any damages, material fatigue (e.g. porous cables) or sediments.
Further instructions depending on the installation spot and usage have to be adhered by a skilled installer and any safety problems have to be removed.

Note: There is no serviceable parts inside the device except for the LED's. Maintenance and service operations are to be carried out by authorized dealers.

Replacing the fuse: Only replace the fuse with the same type and rating.

Replacing the power cable: If the power cable of this device becomes damaged, it has to be replaced by authorized dealers or trained professional only.

Should you have further questions , please contact your dealer.

Parts List

4100-LED	Replacement LED
4100-MPCB	Main PCB card
4100-PS	Power Supply
4100-DIS	Display
4100-DF	Removable Diffusion Filter
4100-DRI	LED Driver PCB
4100-KNOB	Knob Set

4100-POW1M	1 Meter Power jumper cable
4100-POW8M	8 Meter Power jumper cable
4100-RL	Removable Diffusion Lens
4100-BD	Removable Barn Door

Warranty Information

Warranty Conditions

-Unless otherwise stated in writing, your product is covered by a one year parts and labor limited warranty.

-LEDs are not guaranteed to match in color temperature or output.

-It is the owner's responsibility to furnish receipts or invoices for verification of purchase, date, and reseller or distributor. If purchase date cannot be provided, date of manufacture will be used to determine warranty period.

-Goods returned under warranty must follow the proper authorization procedure and must be accompanied by a copy of the original invoice.

-Goods repaired under warranty will be returned to the owner with the freight prepaid by MSI via the most economical means of shipment.

-Repair or replacement as provided for under this warranty is the exclusive remedy of the consumer. MEGA SYSTEMS INC. makes no warranties, express or implied, with respect to any product, and Mega Systems specifically disclaims any warranty of merchantability or fitness for a particular purpose. Mega Systems shall not be liable for any indirect, incidental or consequential damage, including lost profit, sustained or incurred in connection with any product or caused by product defect or the partial or total failure of any product regardless of the form of action, weather in contract, tort (including negligence), strict liability or otherwise, and weather or not such damage was foreseen or unforeseen.

- Warranty is void if the product is misused, damaged, modified in any way, or for unauthorized repairs or parts. This warranty gives you specific legal rights, and you may also have other rights which vary from state to state.



Mega-Lite
18668 Highway 16N
Helotes, TX 78023
Ph 210-684-2600 Fax 210-855-6279
www.mega-lite.com / info@mega-lite.com