

MEGA^{LITE}

ARC MEDIUM



USER MANUAL

Table of Contents

Safety Information.....	3
Specifications.....	4
Main Power Connection.....	5
DMX-512 Connection.....	5
Rigging the Fixture.....	6
Main Control Menu.....	6
DMX Profile.....	6
Cleaning & Maintenance.....	7
Parts List.....	7

Check that the unit has not been damaged during transport



Read all cautions and warnings
prior to operation of this
equipment

Protection Against Fire



Fire

1. Maintain a minimum of 1 foot distance from any type of flame.
3. Replace fuse only with the specified type and rating.
4. Do Not install the unit too close to a heat source.
5. Make sure cables are properly secured away from unit movement.

Protection Against Fire



Electrical

1. Disconnect power before servicing.
2. For connection to main power supply proceed to page 5.
3. This unit must be earthed. (electronically grounded)

Protection Against Mechanical Hazards



Mechanical

1. Use safety chain when hanging unit.
2. Use quality clamps or bolts when positioning unit.
3. Do not open unit while it is on, risk of electrical shock.

Specifications

Part Numbers

Fixture

4205- Arc Medium

Mechanical Specifications

DMX Connectors: 3-pin XLR IP connectors

Power Connection: Edison

IP Rating: IP 65

Display: Digital display

Fastening System: Mounting Yoke

Material: Die Cast aluminum

Fixture	Packaged for Shipping
Size: 13.5L x 3.4W x 13.5/8H	Size: 15.5L x 5.4W x 13.75H
Weight: 12 lbs	Weight: 13lbs

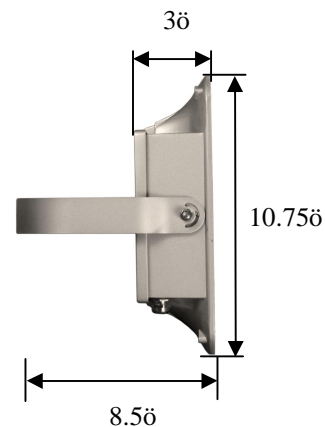

Electrical Specifications

LED Quantity: 48

Red: 16

Green: 16

Blue: 16

LED Watts: 1 watt

LED Manufacture: Bridge Lux

LED Lifetime: 60,000 to 100,000 hours

LED Angle: 30° (± 5°)

Power Consumption: Universal 100 - 240V 50/60 Hz

Ballast: Electronic

Watts: 59

Amps: .81

Control & Programming

Protocol: DMX 512

DMX Mode: 3 DMX channels R,G,B

Main Power Connection

Caution!



1. Do not connect fixture to a dimmer system.
2. This unit has Auto switching power supply. It will respond to 110V or 220V automatically
3. This unit must be earthed. (electronically grounded)
4. Replace fuse only with the specified type and rating.

The occupation of the connection-cable is as follows:

110V Connection

Cable (USA)	Cable (EU)	Pin	Connection
Black	Brown	Live	L
White	Light Blue	Neutral	N
Green	Yellow/Green	Ground	

220V Connection

Cable (USA)	Cable (EU)	Pin	Connection
Black	Brown	Live	L
White	Light Blue	Live	N
Green	Yellow/Green		

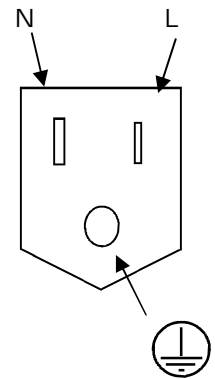

DMX-512 Connection

The fixture is equipped with 3 pin XLR Sockets for DMX input and output. The sockets are wired in parallel. Only use a shielded twisted pair cable designed for RS-485 and 3 pin XLR plugs and connectors in order to connect the controller with the fixture or the fixture with another.

DMX—input

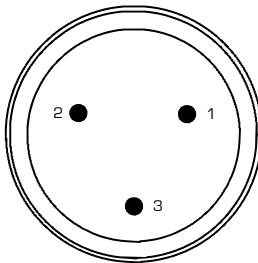

1. Shield
2. Signal (-)
3. Signal (+)

DMX—output

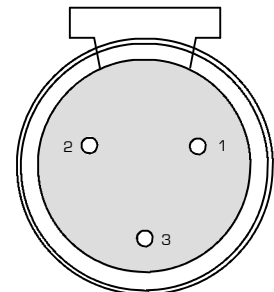

Caution!

At the last fixture the DMX signal needs to be terminated with a terminator. Solder a 120 Ohm resistor between the (-) and the (+) signal into a 3 pin XLR plug and plug it in to the last fixture on the signal run. Pre-manufactured terminator plugs are available for purchase from your Mega-Lite dealer (HOS-DMXT).

Rigging the fixture

Caution!

1. The installations must be carried out by an authorized dealer or trained professional.
2. Unit may cause severe injuries if you have doubts concerning the safety do not install.
3. Unit is to be 24 inches away from flammable materials (decoration material)
4. Use high quality installation equipment to hang unit.

When rigging a unit it is very important that you follow common safety procedures. Rigging requires extensive experience including but not limited to calculating working loads, material being used and periodic safety inspections. If you lack these qualifications, do not attempt the installation yourself, instead use a professional structural rigger.

When rigging the unit always be secured with a secondary safety attachment. The installation location of the projector has got to be built in the way that it can hold 10 times the weight for 1 hour with out any harming. Installation should be checked at least one time a year by a skilled person.

Main Control Menu

The control board on the fixture base is your interface to access and control all the functions on the unit. Its digital display gives you the DMX start channel.

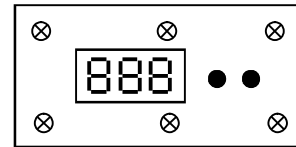

Stand Alone Mode

If addressed to 001 and there is no DMX signal preset unit will run a preset program that will continue to repeat it self.

DMX Mode

If the DMX signal is connected stand alone mode will automatically shut off and 3 channel AWW mode will be start. By pressing the up and down buttons you will be able to select the fixture start channel.

DMX Profile

Arc Medium (3 Channels)

DMX Channel	Function	Description	Value
1	LED Color	Red LED (0-100%)	0-255
2	LED Color	Green LED (0-100%)	0-255
3	LED Color	Blue LED (0-100%)	0-255

Cleaning and maintenance

Installation Maintenance: The operator has to make sure that the unit is operating safely and has the installations and electronics checked by an expert every 2 years.

The following points have to be considered during the inspection:

- 1) All screws used for installing the device or part of the device have to be tightly connected and must not be corroded.
- 2) There must not be any deformations on the housing, fixation and installation spots (ceiling, suspension, trussing).
- 3) The electronic power supply cables must not show any damages, material fatigue (e.g. porous cables) or sediments. Further instructions depending on the installation spot and usage have to be adhered by a skilled installer and any safety problems have to be removed.

Disconnect from mains before starting maintenance operation!



Caution Danger to life!

Electrical

We recommend a frequent cleaning of the device. Please use a moist, lint free cloth. Never use alcohol or solvents!

Note: There is no serviceable parts inside the device except for the LED's. Maintenance and service operations are to be carried out by authorized dealers.

Replacing the fuse: Only replace the fuse with the same type and rating.

Replacing the power cable: If the power cable of this device becomes damaged, it has to be replaced by authorized dealers only in order to avoid hazards.

Should you have further questions , please contact your dealer.

Parts List

4205-Glass	Front Glass replacement
4205-MainC	Main PCB Card
4205-LEDWWA	LED kit WWA
4205-ps	Power Supply
4205-dmx	XLR Connections
4205-LEDA	Amber LED
4205-LEDW	White LED

Warranty Information

Limited Warranty

Unless otherwise stated, your product is covered by a one year parts and labor limited warranty. Dichroic filters and glass gobos are not guaranteed against breakage or scratches to coating. It is the owner's responsibility to furnish receipts or invoices for verification of purchase, date, and dealer or distributor. If purchase date cannot be provided, date of manufacture will be used to determine warranty period.

Returning an Item Under Warranty for Repair

It is necessary to obtain a Return Material Authorization (RMA) number from your dealer or point of purchase BEFORE any units are returned for repair. The manufacturer will make the final determination as to whether or not the unit is covered by warranty. Lamps are covered by the lamp manufacturer's warranty.

Any Product unit or parts returned to MEGA Systems Inc. must be packaged in a suitable manner to ensure the protection of such Product unit or parts, and such package shall be clearly and prominently marked to indicate that the package contains returned Product units or parts and with an RMA number. Accompany all returned Product units or parts with a written explanation of the alleged problem or malfunction. Ship returned Product units or parts to: 5711 Kenwick St. San Antonio TX 78254 USA.

Note: Freight Damage Claims are invalid for fixtures shipped in non-factory boxes and packing materials.

Freight

All shipping will be paid by the purchaser. Items under warranty shall have return shipping paid by the manufacturer only in the Continental United States. Under no circumstances will freight collect shipments be accepted. Prepaid shipping does not include rush expediting such as air freight. Air freight can be sent customer collect in the Continental United States.

REPAIR OR REPLACEMENT AS PROVIDED FOR UNDER THIS WARRANTY IS THE EXCLUSIVE REMEDY OF THE CONSUMER. MEGA SYSTEMS INC. MAKES NO WARRANTIES, EXPRESS OR IMPLIED, WITH RESPECT TO ANY PRODUCT, AND MEGA SYSTEMS SPECIFICALLY DISCLAIMS ANY WARRANTY OF MERCHANTABILITY OR FITNESS FOR A PARTICULAR PURPOSE. MEGA SYSTEMS SHALL NOT BE LIABLE FOR ANY INDIRECT, INCIDENTAL OR CONSEQUENTIAL DAMAGE, INCLUDING LOST PROFITS, SUSTAINED OR INCURRED IN CONNECTION WITH ANY PRODUCT OR CAUSED BY PRODUCT DEFECTS OR THE PARTIAL OR TOTAL FAILURE OF ANY PRODUCT REGARDLESS OF THE FORM OF ACTION, WHETHER IN CONTRACT, TORT (INCLUDING NEGLIGENCE), STRICT LIABILITY OR OTHERWISE, AND WHETHER OR NOT SUCH DAMAGE WAS FORESEEN OR UNFORESEEN. Warranty is void if the product is misused, damaged, modified in any way, or for unauthorized repairs or parts. This warranty gives you specific legal rights, and you may also have other rights which vary from state to state.

MEGA
WWW.MEGA-LITE.COM

Mega-Lite
5718 Kenwick St
San Antonio, TX 78238
Ph 210-684-2600 Fax 210-855-6279
www.mega-lite.com / info@mega-lite.com