

MEGA LITE™

CIRCA^{XL}

S C O O P L E D



USER MANUAL

Table of Contents

Safety Information.....	3
Specifications.....	4
Size.....	5
Main Power Connection.....	6
DMX-512 Connection.....	6
Main Control Menu.....	7
Rigging the Fixture.....	9
DMX Profile.....	9
Cleaning & Maintenance.....	13
Parts List.....	13
Accessories.....	13

Check that the unit has not been damaged during transport



Read all cautions and warnings
prior to operation of this
equipment

Protection Against Fire



Fire

1. Maintain a minimum of 1 foot distance from any type of flame.
3. Replace fuse only with the specified type and rating.
4. Do Not install the unit too close to a heat source.
5. Make sure cables are properly secured away from unit movement.
6. Maximum surface operating temperature 104°.

Protection Against Electrical Damage



Electrical

1. Disconnect power before lamp replacement or servicing.
2. For connection to main power supply proceed to page 6.
3. This unit must be earthed. (electronically grounded)
4. Do not expose unit to rain or moisture.
5. Unit must not be left on for a long period of time.

Protection Against Mechanical Hazards



Mechanical

1. Use safety chain when hanging unit.
2. Use quality clamps or bolts when positioning unit
3. Do not open unit risk of electrical shock.

Specifications

Part Numbers

Fixture

5201- Circa Scoop XL LED

Flight Case

CAS-5201-2

Dual Road Case

Mechanical Specifications

DMX Connectors: 5-pin XLR Connectors
Power Connectors: Power Con Type
Mounting Yoke: Square Yoke
Thermal: Maximum ambient temperature 110° F
Maximum surface temperature 140° F
Fastening System: 2 Quick Release Clamp Mounts

Electrical Specifications

LED Quantity: 464 RGB 108 Warm White 60 Warm White + Amber **SMD LEDs Watts:** 0.8 Watt each
Fuse: 5x20 F5AL250V
LED Angle: 140° (outer ring)
Power Input Voltage: 110V-240 50/60 Hz
Ballast: Electronic auto switching
Power Consumption **Watts:** 528
Amps: 4.57
LED Lifetime: *60 to 100 thousand hours
Scan Rate: 7000Hz

Control & Programming

DMX 512 Protocol

DMX Modes:

Mode 1	2 Channels	Dimmer, Macro
Mode 2	3 Channels	Dimmer, Warm White, Amber
Mode 3	17 Channels	Dimmer, Outer R, G, B, Macro, Macro Speed, Outer Strobe, Inner R, G, B, Macro, Macro Speed, Inner Strobe, Warm White, Amber, Reflective Center, Center Strobe
Mode 4	52 Channels	Dimmer, Outer, RGB x 8, Inner RGB x 8, Warm White, Amber, Reflective Warm White
Mode 5	55 Channels	Dimmer, Outer, RGB x 8, Outer Strobe, Inner RGB x 8, Inner Strobe, Warm White, Amber, Reflective Warm White, Center Strobe

Control Options: Display Control

*LED Manufactures rated average life span

Size

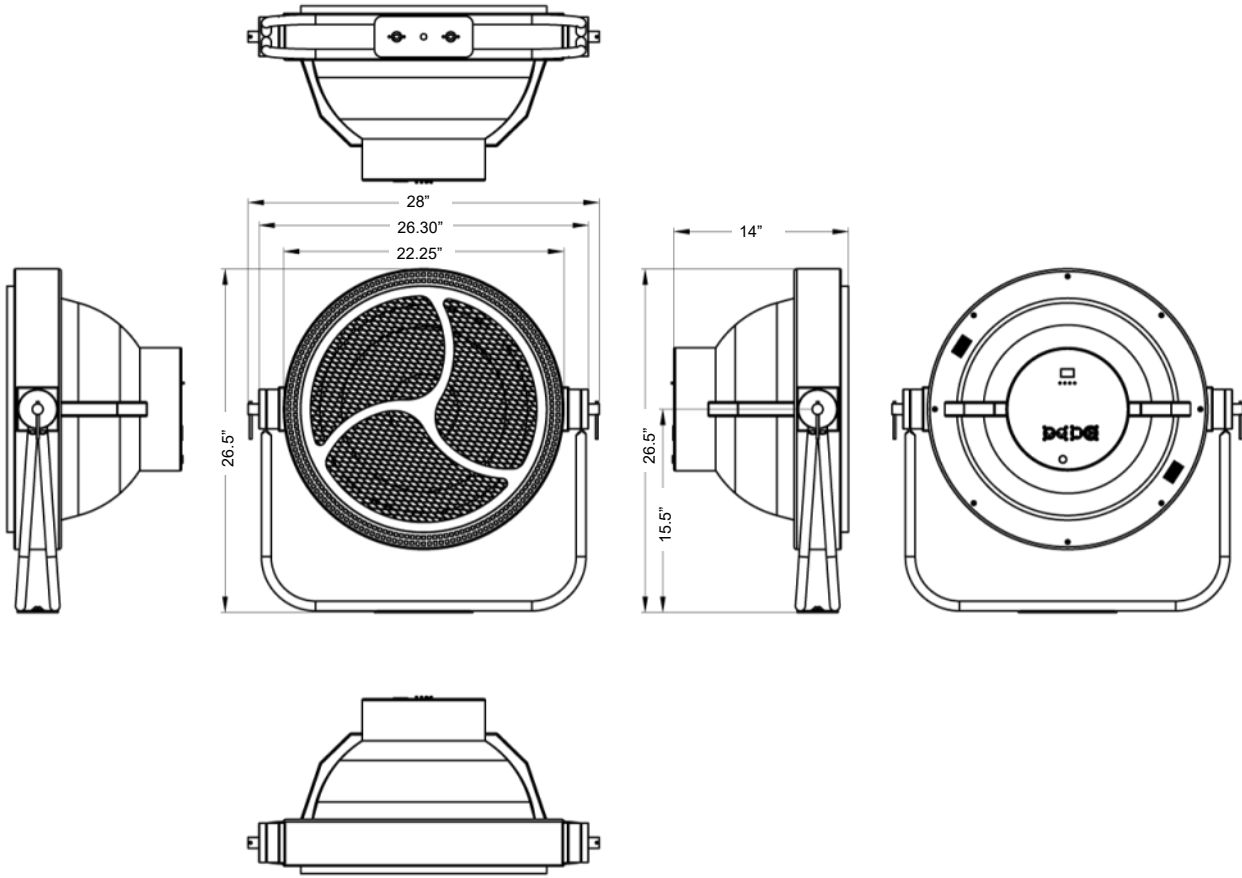

Fixture Size
28" X 14" X 26.5"
Fixture Weight
27lb

Packaged Size
32.5" X 18.5" X 30"
Packaged Weight
35.5lb



Main Power Connection

Caution!

1. Do not connect fixture to a dimmer system.
2. This unit must be earthed. (electronically grounded)
3. Replace fuse only with the specified type and rating.
4. Power link maximum 3 units at 110V

This device is equipped with a auto switching power supply that will allow you to work from 100V-240V 50/60Hz

The occupation of the connection-cable is as follows:

Cable (USA)	Cable (EU)	Pin	110V	220V
Black	Brown	Live	L	L
White	Light Blue	Neutral	N	L
Green	Yellow/Green	Ground		

110V
Connection

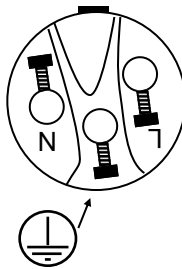

220V
Connection

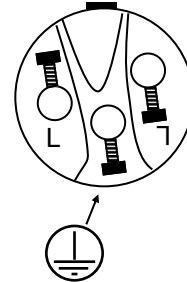

DMX-512 Connection

The fixture is equipped with 5 pin XLR Sockets for DMX input and output. The sockets are wired in parallel. Only use a shielded twisted pair cable designed for RS-485 and 5 pin XLR plugs and connectors in order to connect the controller with the fixture or the fixture with another.

DMX—Input

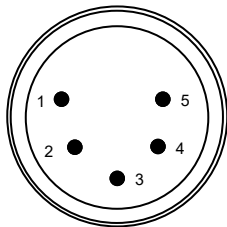

1. Shield
2. Signal (-)
3. Signal (+)
4. N/A
5. N/A

DMX—Output

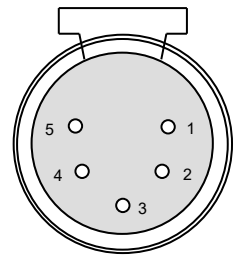

Caution!

At the last fixture the DMX signal needs to be terminated with a terminator. Solder a 120 Ohm resistor between the (-) and the (+) signal into a 5 pin XLR plug and plug it in to the last fixture on the signal run. Pre-manufactured terminator plugs are available for purchase from your Mega-Lite dealer (P-DMX-T).

Display Control

Mega Lite
Circa XL Scoop
V1.2

● ● ● ●
ESC DOWN UP ENTER

Address 001 DMX On	<h3>DMX Address</h3> <p>Press Enter to select the DMX start channel. Use the up/down keys (001 to 512) , Press Enter to confirm the setting. Press ESC to return to Main Menu. (Notes: Display must be on Main Menu for fixture to operate on DMX Mode)</p>
--------------------------	---

Main Menu > Channel Mode LED Dimmer LED Strobe	<h3>Channel Mode</h3> <p>Press Enter to select the DMX Channel mode of operation. Use the up/down keys to select Channel mode from</p> <table border="1" style="width: 100%; border-collapse: collapse;"> <tr> <td style="width: 10%; padding: 2px;">2 CH</td> <td style="padding: 2px;">Dimmer, Macro</td> </tr> <tr> <td style="padding: 2px;">3 CH</td> <td style="padding: 2px;">Dimmer, Warm White, Amber</td> </tr> <tr> <td style="padding: 2px;">17 CH</td> <td style="padding: 2px;">Dimmer, Outer R,G,B, Macro, Macro Speed, Outer Strobe, Inner R,G,B, Macro, Macro Speed, Inner Strobe, Warm White, Amber ,Reflective Center, Center Strobe</td> </tr> <tr> <td style="padding: 2px;">52 CH</td> <td style="padding: 2px;">Dimmer, Outer RGBx8, Inner RGBx8,Warm White, Amber, Reflective Warm White</td> </tr> <tr> <td style="padding: 2px;">55 CH</td> <td style="padding: 2px;">Dimmer, Outer RGBx8, Outer Strobe, Inner RGBx8, Inner Strobe, Warm White, Amber, Reflective Center, Center Strobe</td> </tr> </table> <p style="text-align: center;">Press Enter to confirm the setting. Press ESC to return to Main Menu.</p>	2 CH	Dimmer, Macro	3 CH	Dimmer, Warm White, Amber	17 CH	Dimmer, Outer R,G,B, Macro, Macro Speed, Outer Strobe, Inner R,G,B, Macro, Macro Speed, Inner Strobe, Warm White, Amber ,Reflective Center, Center Strobe	52 CH	Dimmer, Outer RGBx8, Inner RGBx8,Warm White, Amber, Reflective Warm White	55 CH	Dimmer, Outer RGBx8, Outer Strobe, Inner RGBx8, Inner Strobe, Warm White, Amber, Reflective Center, Center Strobe
2 CH	Dimmer, Macro										
3 CH	Dimmer, Warm White, Amber										
17 CH	Dimmer, Outer R,G,B, Macro, Macro Speed, Outer Strobe, Inner R,G,B, Macro, Macro Speed, Inner Strobe, Warm White, Amber ,Reflective Center, Center Strobe										
52 CH	Dimmer, Outer RGBx8, Inner RGBx8,Warm White, Amber, Reflective Warm White										
55 CH	Dimmer, Outer RGBx8, Outer Strobe, Inner RGBx8, Inner Strobe, Warm White, Amber, Reflective Center, Center Strobe										

Main Menu Channel Mode > LED Dimmer LED Strobe	<h3>LED Dimmer</h3> <p>For LED Dimmer control press Enter. Select from 255 steps. Of the 52 ch. Press ESC to return to Main Menu.</p>
--	---

Main Menu Channel Mode LED Dimmer > LED Strobe	<h3>Strobe</h3> <p>This function allows you to select a preprogrammed strobe sequences. Press Enter use the up/down keys to select desired strobe program (15 options). Press Enter to set the desired sped use the up/down keys (15 options). Press Enter to confirm the settings. (note; Dimmer of selected intensity must be dimmed prior in Dimmer option)</p>
--	---

Main Menu > Fan Test Auto Mode Auto Speed	<h3>Fan Test</h3> <p>Press Up Or Down. Select from Center Fan Test or Ring Fan Test</p>
---	--

Main Menu >Auto Mode Auto Speed Temperature	<h3>Auto Mode</h3> <p>Press Enter. Select from 6 modes Press ESC to return to Main Menu.</p> <p>(Note: If you want to have fixture remain on Auto Test do not press ESC and just power off and on fixture to return to last setting)</p>
--	--

Main Menu Auto Mode >Auto Speed Temperature	<h3>Auto Speed</h3> <p>Press Enter. Select from 6 modes Press ESC to return to Main Menu.</p> <p>(Note: If you want to have fixture remain on Auto Test do not press ESC and just power off and on fixture to return to last setting)</p>
--	---

Main Menu Auto Mode Auto Speed >Temperature	<h3>Temperature</h3> <p>This fixture is equipped with internal temperature sensors. Once head reaches a temperature of 96°the IP rated fan will engage</p>
--	--

Main Menu Dimmer Speed Temperature >Setting	<h3>Setting</h3> <p>Setting Control Options</p>
Config Menu >Oled Back Light DMX Fail Dimmer Setting	<p>To turn off display screen after 2 minutes of no use select Disable. To enable screen to remain on when in use select Enable.</p>
Config Menu LCD Back Light >DMX Fail Dimmer Setting	<p>To hold the last DMX command in case of DMX Signal loss select Enable. To have the fixture DMX Setting at 0 if DMX signal is loss use Disable option.</p>
Config Menu LCD Back Light DMX Fail >Dimmer Setting	<p>Select Dimmer Setting to be used for dimming type when used in Ch3 mode.</p> <p>Linear Square Law Inv. Square Law S Type</p>
Config Menu DMX Fail Dimmer Setting >Factory Reset	<p>Restore fixture to original factory display settings</p>

Rigging the fixture

Caution!

1. The installations must be carried out by an authorized dealer or trained professional.
2. Unit may cause severe injuries if you have doubts concerning the safety do not install.
3. Unit is to be 24 inches away from flammable materials (decoration material)
4. Use high quality installation equipment to hang unit.

When rigging a unit it is very important that you follow common safety procedures. Rigging requires extensive experience including but not limited to calculating working loads, material being used and periodic safety inspections. If you lack these qualifications, do not attempt the installation yourself, instead use a professional structural rigger.

When rigging the unit always be secured with a secondary safety attachment. The installation location of the projector has got to be built in the way that it can hold 10 times the weight for 1 hour with out any harming. Installation should be checked at least one time a year by a skilled person.

DMX Profile

Circa XL Scoop LED 2 Ch Mode

DMX Channel	Function	Description	Value	Init
1	Dimmer	Dimmer Off to Full	0-255	255
2	Macro	No Function	0-41	0
		Macro 1 (slow to fast)	42-83	
		Macro 2 (slow to fast)	84-125	
		Macro 3 (slow to fast)	126-167	
		Macro 4 (slow to fast)	168-209	
		Macro 5 (slow to fast)	210-255	

Circa XL Scoop LED 3 Ch Mode

DMX Channel	Function	Description	Value	Init
1	Dimmer	Dimmer Off to Full	0-255	255
2	LED Color	Center & Back Warm White	0-255	255
3	LED Color	Center Amber	0-255	255

Circa XL Scoop LED 17 Ch Mode

DMX Channel	Function	Description	Value	Init
1	Dimmer	Master Dimmer Off to Full	0-255	255
2	LED Color	Outer Red LED intensity	0-255	255
3	LED Color	Outer Green LED Intensity	0-255	255
4	LED Color	Outer Blue LED Intensity	0-255	255
5	Outer Ring Macro (Select Color)	No Function	0-1	0
		Fade Clockwise	2-24	
		Fade Counter Clockwise	25-49	
		Snap Clockwise	50-74	
		Snap Counter Clockwise	75-99	
		2468 then 1357 Fade	100-124	
		2468 then 1357 Snap	125-149	
		Bounce Fade 12345678765432	150-174	
		Bounce Snap 12345678765432	175-199	
		Top to Bottom 18,27,34,56,34,27	200-224	
Side to Side 23,14,85,76	225-255			
6	Macro Speed	Outer Ring Macro Speed	0-255	0
7	Outer Ring Strobe	No Function	0-1	0
		Strobe (slow to fast)	1-127	
		Strobe Pulse (slow to fast)	128-170	
		Random Strobe All (slow to fast)	171-213	
		Random 1-8 Strobe (slow to fast)	214-255	
8	LED Color	Inner Red LED intensity	0-255	255
9	LED Color	Inner Green LED Intensity	0-255	255
10	LED Color	Inner Blue LED Intensity	0-255	255
11	Inner Ring Macro (Select Color)	No Function	0-1	0
		Fade Clockwise	2-24	
		Fade Counter Clockwise	25-49	
		Snap Clockwise	50-74	
		Snap Counter Clockwise	75-99	
		2468 then 1357 Fade	100-124	
		2468 then 1357 Snap	125-149	
		Bounce Fade 12345678765432	150-174	
		Bounce Snap 12345678765432	175-199	
		Top to Bottom 18,27,34,56,34,27	200-224	
Side to Side 23,14,85,76	225-255			
12	Macro Speed	Inner Ring Macro Speed	0-255	0
13	Inner Ring Strobe	No Function	0-1	0
		Strobe (slow to fast)	2-127	
		Strobe Pulse (slow to fast)	128-170	
		Random Strobe All (slow to fast)	171-213	
		Random 1-8 Strobe (slow to fast)	214-255	
14	Warm White	Center Warm White	0-255	255
15	Amber	Center Amber	0-255	255
16	Warm White	Center Reflective Warm White	0-255	255
17	Center Strobe	No Function	0-1	0
		Strobe (slow to fast)	2-127	
		Strobe Pulse (slow to fast)	128-170	
		Random Strobe All (slow to fast)	171-213	
		Random Strobe 1-3 (slow to fast)	214-255	

Circa XL Scoop LED 52 Ch Mode

DMX Channel	Function	Description	Value	Init
1	Dimmer	Master Dimmer Off to Full	0-255	255
2	LED Color	Outer 1 Red LED intensity	0-255	0
3	LED Color	Outer 1 Green LED intensity	0-255	0
4	LED Color	Outer 1 Blue LED intensity	0-255	0
5	LED Color	Outer 2 Red LED intensity	0-255	0
6	LED Color	Outer 2 Green LED intensity	0-255	0
7	LED Color	Outer 2 Blue LED intensity	0-255	0
8	LED Color	Outer 3 Red LED intensity	0-255	0
9	LED Color	Outer 3 Green LED intensity	0-255	0
10	LED Color	Outer 3 Blue LED intensity	0-255	0
11	LED Color	Outer 4 Red LED intensity	0-255	0
12	LED Color	Outer 4 Green LED intensity	0-255	0
13	LED Color	Outer 4 Blue LED intensity	0-255	0
14	LED Color	Outer 5 Red LED intensity	0-255	0
15	LED Color	Outer 5 Green LED intensity	0-255	0
16	LED Color	Outer 5 Blue LED intensity	0-255	0
17	LED Color	Outer 6 Red LED intensity	0-255	0
18	LED Color	Outer 6 Green LED intensity	0-255	0
19	LED Color	Outer 6 Blue LED intensity	0-255	0
20	LED Color	Outer 7 Red LED intensity	0-255	0
21	LED Color	Outer 7 Green LED intensity	0-255	0
22	LED Color	Outer 7 Blue LED intensity	0-255	0
23	LED Color	Outer 8 Red LED intensity	0-255	0
24	LED Color	Outer 8 Green LED intensity	0-255	0
25	LED Color	Outer 8 Blue LED intensity	0-255	0
26	LED Color	Inner 1 Red LED intensity	0-255	0
27	LED Color	Inner 1 Green LED intensity	0-255	0
28	LED Color	Inner 1 Blue LED intensity	0-255	0
29	LED Color	Inner 2 Red LED intensity	0-255	0
30	LED Color	Inner 2 Green LED intensity	0-255	0
31	LED Color	Inner 2 Blue LED intensity	0-255	0
32	LED Color	Inner 3 Red LED intensity	0-255	0
33	LED Color	Inner 3 Green LED intensity	0-255	0
34	LED Color	Inner 3 Blue LED intensity	0-255	0
35	LED Color	Inner 4 Red LED intensity	0-255	0
36	LED Color	Inner 4 Green LED intensity	0-255	0
37	LED Color	Inner 4 Blue LED intensity	0-255	0
38	LED Color	Inner 5 Red LED intensity	0-255	0
39	LED Color	Inner 5 Green LED intensity	0-255	0
40	LED Color	Inner 5 Blue LED intensity	0-255	0
41	LED Color	Inner 6 Red LED intensity	0-255	0
42	LED Color	Inner 6 Green LED intensity	0-255	0
43	LED Color	Inner 6 Blue LED intensity	0-255	0
44	LED Color	Inner 7 Red LED intensity	0-255	0
45	LED Color	Inner 7 Green LED intensity	0-255	0
46	LED Color	Inner 7 Blue LED intensity	0-255	0
47	LED Color	Inner 8 Red LED intensity	0-255	0
48	LED Color	Inner 8 Green LED intensity	0-255	0
49	LED Color	Inner 8 Blue LED intensity	0-255	0
50	LED Color	Center Warm White	0-255	0
51	LED Color	Center Amber	0-255	0
52	LED Color	Reflective Warm White	0-255	0

Circa XL Scoop LED 55 Ch Mode

DMX Channel	Function	Description	Value	Init
1	Dimmer	Master Dimmer Off to Full	0-255	255
2	LED Color	Outer 1 Red LED intensity	0-255	0
3	LED Color	Outer 1 Green LED intensity	0-255	0
4	LED Color	Outer 1 Blue LED intensity	0-255	0
5	LED Color	Outer 2 Red LED intensity	0-255	0
6	LED Color	Outer 2 Green LED intensity	0-255	0
7	LED Color	Outer 2 Blue LED intensity	0-255	0
8	LED Color	Outer 3 Red LED intensity	0-255	0
9	LED Color	Outer 3 Green LED intensity	0-255	0
10	LED Color	Outer 3 Blue LED intensity	0-255	0
11	LED Color	Outer 4 Red LED intensity	0-255	0
12	LED Color	Outer 4 Green LED intensity	0-255	0
13	LED Color	Outer 4 Blue LED intensity	0-255	0
14	LED Color	Outer 5 Red LED intensity	0-255	0
15	LED Color	Outer 5 Green LED intensity	0-255	0
16	LED Color	Outer 5 Blue LED intensity	0-255	0
17	LED Color	Outer 6 Red LED intensity	0-255	0
18	LED Color	Outer 6 Green LED intensity	0-255	0
19	LED Color	Outer 6 Blue LED intensity	0-255	0
20	LED Color	Outer 7 Red LED intensity	0-255	0
21	LED Color	Outer 7 Green LED intensity	0-255	0
22	LED Color	Outer 7 Blue LED intensity	0-255	0
23	LED Color	Outer 8 Red LED intensity	0-255	0
24	LED Color	Outer 8 Green LED intensity	0-255	0
25	LED Color	Outer 8 Blue LED intensity	0-255	0
26	Outer Strobe	No Function	0-1	0
		Strobe (slow to fast)	2-127	
		Strobe Pulse (slow to fast)	128-170	
		Random Strobe All (slow to fast)	171-213	
		Random Strobe 1-3 (slow to fast)	214-255	
27	LED Color	Inner 1 Red LED intensity	0-255	0
28	LED Color	Inner 1 Green LED intensity	0-255	0
29	LED Color	Inner 1 Blue LED intensity	0-255	0
30	LED Color	Inner 2 Red LED intensity	0-255	0
31	LED Color	Inner 2 Green LED intensity	0-255	0
32	LED Color	Inner 2 Blue LED intensity	0-255	0
33	LED Color	Inner 3 Red LED intensity	0-255	0
34	LED Color	Inner 3 Green LED intensity	0-255	0
35	LED Color	Inner 3 Blue LED intensity	0-255	0
36	LED Color	Inner 4 Red LED intensity	0-255	0
37	LED Color	Inner 4 Green LED intensity	0-255	0
38	LED Color	Inner 4 Blue LED intensity	0-255	0
39	LED Color	Inner 5 Red LED intensity	0-255	0
40	LED Color	Inner 5 Green LED intensity	0-255	0
41	LED Color	Inner 5 Blue LED intensity	0-255	0
42	LED Color	Inner 6 Red LED intensity	0-255	0
43	LED Color	Inner 6 Green LED intensity	0-255	0
44	LED Color	Inner 6 Blue LED intensity	0-255	0
45	LED Color	Inner 7 Red LED intensity	0-255	0
46	LED Color	Inner 7 Green LED intensity	0-255	0
47	LED Color	Inner 7 Blue LED intensity	0-255	0
48	LED Color	Inner 8 Red LED intensity	0-255	0
49	LED Color	Inner 8 Green LED intensity	0-255	0
50	LED Color	Inner 8 Blue LED intensity	0-255	0
51	Inner Strobe	No Function	0-1	0
		Strobe (slow to fast)	2-127	
		Strobe Pulse (slow to fast)	128-170	
		Random Strobe All (slow to fast)	171-213	
		Random Strobe 1-8 (slow to fast)	214-255	
52	LED Color	Center Warm White	0-255	0
53	LED Color	Center Amber	0-255	0
54	LED Color	Reflective Warm White	0-255	0
55	Center Strobe	No Function	0-1	0
		Strobe (slow to fast)	2-127	
		Strobe Pulse (slow to fast)	128-170	
		Random Strobe All (slow to fast)	171-213	
		Random Strobe 1-3 (slow to fast)	214-255	

Cleaning and Maintenance

Installation Maintenance: The operator has to make sure that the unit is operating safely and has the installations and electronics checked by an expert every 2 years.

The following points have to be considered during the inspection:

- 1) All screws used for installing the device or part of the device have to be tightly connected and must not be corroded.
- 2) There must not be any deformations on the housing, fixation and installation spots (ceiling, suspension, trussing).
- 3) Mechanically moved parts like axles and other must not show any traces of wearing and must not rotate with unbalances.
- 4) The electronic power supply cables must not show any damages, material fatigue (e.g. porous cables) or sediments. Further instructions depending on the installation spot and usage have to be adhered by a skilled installer and any safety problems have to be removed.

Disconnect from mains before starting maintenance operation!

Caution Danger to life!



Electrical

We recommend a frequent cleaning of the device. Please use a moist, lint free cloth. Never use alcohol or solvents!

- 1) The objective lens will require periodic cleaning on usage and environment. Environment with foggers will require more periodic cleaning as fog fluid tends to build up residues, reducing the light output.
- 2) The cooling-fans should be cleaned monthly. DO NOT blow high pressure air into fans as incorrect rotation can damage the fans operation.
- 3) The gobos, dichroic color filters and internal lenses may be cleaned with soft brush using soapy water.
- 4) The interior of the fixture should be cleaned using a vacuum.
- 5) We recommend proper lubrication of the motor wheel. The quantity of the oil must not be excessive in order to avoid oil run outs when motor wheel rotate

Note: There is no serviceable parts inside the device except for the fuse. Maintenance and service operations are to be carried out by authorized dealers.

Replacing the fuse: Only replace the fuse with the same type and rating.

Replacing the power cable: If the power cable of this device becomes damaged, it has to be replaced by authorized dealers only

Should you have further questions , please contact your dealer.

Parts List

5201-LED-MOD-O	LED Module Outer Ring (half)
5201-LED-MOD-I	LED Module Inner (segment)
5201-LED-MOD-C	LED Module Center
5201-LED-MOD-R	LED Module Reflective Ring (half)
5201-LED-MOD-RC	LED Module Reflective Center (1/3)
5201-POW	Power Supply
5201-PCB-DRI-A	PCB Driver A
5201-PCB-DRI-B	PCB Driver B
5201-PCB-MAI-DIS	Display and Main PCB

5201-PCB-POW	PCB for Power Distribution
5201-BEZ-RIN	Outer Ring Milky Diffusion Plastic
5200-BEZ-CEN	Center Globe Filter Plastic
5200-FAN-HW5	HW5020B Fan
5200-FAN-X.W	X.W-6010M24B Fan
5200-HOU-NET	Housing Net
5200-HOU-KNO	Housing base for Knob
5200-KNO	Knob
5200-HOU-QUI	Quick Release Clamp Mount

Accessories

5201-ACC-BAS	Removable Floor Base
5201-ACC-SMO	Smoke Ring Filter
CAS-5201-2	2 Unit Road Case

Warranty Information

Warranty Conditions

-Unless otherwise stated in writing, your product is covered by a one year parts and labor limited warranty.

-LED's or Lamp's are not guaranteed to match in color temperature or output.

-It is the owner's responsibility to furnish receipts or invoices for verification of purchase, date, and reseller or distributor. If purchase date cannot be provided, date of manufacture will be used to determine warranty period.

-Goods returned under warranty must follow the proper authorization procedure and must be accompanied by a copy of the original invoice.

-Goods repaired under warranty will be returned to the owner with the freight prepaid by MSI via the most economical means of shipment.

-Repair or replacement as provided for under this warranty is the exclusive remedy of the consumer. MEGA SYSTEMS INC. makes no warranties, express or implied, with respect to any product, and Mega Systems specifically disclaims any warranty of merchantability or fitness for a particular purpose. Mega Systems shall not be liable for any indirect, incidental or consequential damage, including lost profit, sustained or incurred in connection with any product or caused by product defect or the partial or total failure of any product regardless of the form of action, weather in contract, tort (including negligence), strict liability or otherwise, and weather or not such damage was foreseen or unforeseen.

- Warranty is void if the product is misused, damaged, modified in any way, or for unauthorized repairs or parts. This warranty gives you specific legal rights, and you may also have other rights which vary from state to state.

Customer Support

Mega Lite has a customer support line to provide set up help and to answer any question should you encounter a problem. Please visit our website for any other related technical documents. For service related issue please contact our service dept.

Monday—Friday 9am to 6pm CST

Voice: 210-684-2600

E-mail: service@mega.lighting

Specifications in this manual are subject to change.



Mega-Lite
18668 Highway 16N
Helotes, TX 78023
Ph 210-684-2600 Fax 210-855-6279
www.mega.lighting / info@mega.lighting