

Fantom X6

Fantom X7

Fantom X8

Owner's Manual

Thank you, and congratulations on your choice of the Roland Fantom-X6/X7/X8.

Before using this unit, carefully read the sections entitled: "IMPORTANT SAFETY INSTRUCTIONS" (p. 2), "USING THE UNIT SAFELY" (p. 3-4), and "IMPORTANT NOTES" (p. 4-5). These sections provide important information concerning the proper operation of the unit. Additionally, in order to feel assured that you have gained a good grasp of every feature provided by your new unit, Handbook and Owner's manual should be read in its entirety. The manual should be saved and kept on hand as a convenient reference.

This Owner's Manual applies to the Fantom-X6, the Fantom-X7 and the Fantom-X8. The manual uses the term "Fantom-X" to indicate all these three models.

Listening to the Demo Songs

Press [PLAY] to start demo song playback.

To stop the performance, press [STOP].



Rewind



Stop

Play

* The operation described here will play back one demo song.

In addition to this song, the Fantom-X contains other demo songs that let you experience the amazing sounds of the Fantom-X. To listen to these demo songs, refer to p. 23.

WARNING: To reduce the risk of fire or electric shock, do not expose this apparatus to rain or moisture.

  
ATTENTION: RISQUE DE CHOC ELECTRIQUE NE PAS OUVRIR
CAUTION: TO REDUCE THE RISK OF ELECTRIC SHOCK, DO NOT REMOVE COVER (OR BACK). NO USER-SERVICEABLE PARTS INSIDE. REFER SERVICING TO QUALIFIED SERVICE PERSONNEL.



The lightning flash with arrowhead symbol, within an equilateral triangle, is intended to alert the user to the presence of uninsulated "dangerous voltage" within the product's enclosure that may be of sufficient magnitude to constitute a risk of electric shock to persons.



The exclamation point within an equilateral triangle is intended to alert the user to the presence of important operating and maintenance (servicing) instructions in the literature accompanying the product.

INSTRUCTIONS PERTAINING TO A RISK OF FIRE, ELECTRIC SHOCK, OR INJURY TO PERSONS.

IMPORTANT SAFETY INSTRUCTIONS

SAVE THESE INSTRUCTIONS

WARNING - When using electric products, basic precautions should always be followed, including the following:

1. Read these instructions.
2. Keep these instructions.
3. Heed all warnings.
4. Follow all instructions.
5. Do not use this apparatus near water.
6. Clean only with a dry cloth.
7. Do not block any of the ventilation openings. Install in accordance with the manufacturers instructions.
8. Do not install near any heat sources such as radiators, heat registers, stoves, or other apparatus (including amplifiers) that produce heat.
9. Do not defeat the safety purpose of the polarized or grounding-type plug. A polarized plug has two blades with one wider than the other. A grounding type plug has two blades and a third grounding prong. The wide blade or the third prong are provided for your safety. If the provided plug does not fit into your outlet, consult an electrician for replacement of the obsolete outlet.
10. Protect the power cord from being walked on or pinched particularly at plugs, convenience receptacles, and the point where they exit from the apparatus.
11. Only use attachments/accessories specified by the manufacturer.
12. Use only with the cart, stand, tripod, bracket, or table specified by the manufacturer, or sold with the apparatus. When a cart is used, use caution when moving the cart/apparatus combination to avoid injury from tip-over.
13. Unplug this apparatus during lightning storms or when unused for long periods of time.
14. Refer all servicing to qualified service personnel. Servicing is required when the apparatus has been damaged in any way, such as power-supply cord or plug is damaged, liquid has been spilled or objects have fallen into the apparatus, the apparatus has been exposed to rain or moisture, does not operate normally, or has been dropped.



For the U.K.

WARNING: THIS APPARATUS MUST BE EARTHED

IMPORTANT: THE WIRES IN THIS MAINS LEAD ARE COLOURED IN ACCORDANCE WITH THE FOLLOWING CODE.
GREEN-AND-YELLOW: EARTH, BLUE: NEUTRAL, BROWN: LIVE

As the colours of the wires in the mains lead of this apparatus may not correspond with the coloured markings identifying the terminals in your plug, proceed as follows:

The wire which is coloured GREEN-AND-YELLOW must be connected to the terminal in the plug which is marked by the letter E or by the safety earth symbol  or coloured GREEN or GREEN-AND-YELLOW.

The wire which is coloured BLUE must be connected to the terminal which is marked with the letter N or coloured BLACK.

The wire which is coloured BROWN must be connected to the terminal which is marked with the letter L or coloured RED.

USING THE UNIT SAFELY

INSTRUCTIONS FOR THE PREVENTION OF FIRE, ELECTRIC SHOCK, OR INJURY TO PERSONS

About ⚠ WARNING and ⚠ CAUTION Notices

⚠ WARNING	Used for instructions intended to alert the user to the risk of death or severe injury should the unit be used improperly.
⚠ CAUTION	Used for instructions intended to alert the user to the risk of injury or material damage should the unit be used improperly. * Material damage refers to damage or other adverse effects caused with respect to the home and all its furnishings, as well to domestic animals or pets.

About the Symbols

	The ⚠ symbol alerts the user to important instructions or warnings. The specific meaning of the symbol is determined by the design contained within the triangle. In the case of the symbol at left, it is used for general cautions, warnings, or alerts to danger.
	The ⚡ symbol alerts the user to items that must never be carried out (are forbidden). The specific thing that must not be done is indicated by the design contained within the circle. In the case of the symbol at left, it means that the unit must never be disassembled.
	The ⚡ symbol alerts the user to things that must be carried out. The specific thing that must be done is indicated by the design contained within the circle. In the case of the symbol at left, it means that the power-cord plug must be unplugged from the outlet.

ALWAYS OBSERVE THE FOLLOWING



⚠ WARNING

- Before using this unit, make sure to read the instructions below, and the Owner's Manual.
- Connect mains plug of this model to a mains socket outlet with a protective earthing connection.
- Do not open or perform any internal modifications on the unit. (The only exception would be where this manual provides specific instructions which should be followed in order to put in place user-installable options; see p. 240, p. 242, p. 244, p. 246.)
- Do not attempt to repair the unit, or replace parts within it (except when this manual provides specific instructions directing you to do so). Refer all servicing to your retailer, the nearest Roland Service Center, or an authorized Roland distributor, as listed on the "Information" page.
- Never use or store the unit in places that are:
 - Subject to temperature extremes (e.g., direct sunlight in an enclosed vehicle, near a heating duct, on top of heat-generating equipment); or are
 - Damp (e.g., baths, washrooms, on wet floors); or are
 - Humid; or are
 - Exposed to rain; or are
 - Dusty; or are
 - Subject to high levels of vibration.
- This unit should be used only with a rack or stand that is recommended by Roland.
- When using the unit with a rack or stand recommended by Roland, the rack or stand must be carefully placed so it is level and sure to remain stable. If not using a rack or stand, you still need to make sure that any location you choose for placing the unit provides a level surface that will properly support the unit, and keep it from wobbling.
- The unit should be connected to a power supply only of the type described in the operating instructions, or as marked on the unit.
- Use only the attached power-supply cord. Also, the supplied power cord must not be used with any other device.
- Do not excessively twist or bend the power cord, nor place heavy objects on it. Doing so can damage the cord, producing severed elements and short circuits. Damaged cords are fire and shock hazards!





⚠ WARNING

- This unit, either alone or in combination with an amplifier and headphones or speakers, may be capable of producing sound levels that could cause permanent hearing loss. Do not operate for a long period of time at a high volume level, or at a level that is uncomfortable. If you experience any hearing loss or ringing in the ears, you should immediately stop using the unit, and consult an audiologist.
- Do not allow any objects (e.g., flammable material, coins, pins); or liquids of any kind (water, soft drinks, etc.) to penetrate the unit.
- Immediately turn the power off, remove the power cord from the outlet, and request servicing by your retailer, the nearest Roland Service Center, or an authorized Roland distributor, as listed on the "Information" page when:
 - The power-supply cord, or the plug has been damaged; or
 - If smoke or unusual odor occurs
 - Objects have fallen into, or liquid has been spilled onto the unit; or
 - The unit has been exposed to rain (or otherwise has become wet); or
 - The unit does not appear to operate normally or exhibits a marked change in performance.
- In households with small children, an adult should provide supervision until the child is capable of following all the rules essential for the safe operation of the unit.
- Protect the unit from strong impact. (Do not drop it!)
- Do not force the unit's power-supply cord to share an outlet with an unreasonable number of other devices. Be especially careful when using extension cords—the total power used by all devices you have connected to the extension cord's outlet must never exceed the power rating (watts/amperes) for the extension cord. Excessive loads can cause the insulation on the cord to heat up and eventually melt through.
- Before using the unit in a foreign country, consult with your retailer, the nearest Roland Service Center, or an authorized Roland distributor, as listed on the "Information" page.









⚠ WARNING

- Always turn the unit off and unplug the power cord before attempting installation of the circuit board (SRX series; p. 240, p. 242, DIMM; p. 244, p. 246). 
- DO NOT play a CD-ROM disc on a conventional audio CD player. The resulting sound may be of a level that could cause permanent hearing loss. Damage to speakers or other system components may result. 
- Do not put anything that contains water (e.g., flower vases) on this unit. Also, avoid the use of insecticides, perfumes, alcohol, nail polish, spray cans, etc., near the unit. Swiftly wipe away any liquid that spills on the unit using a dry, soft cloth. 

⚠ CAUTION

- The unit should be located so that its location or position does not interfere with its proper ventilation. 
- This unit for use only with Roland stand KS-12 (Fantom-X6/ Fantom-X7) / KS-17 (Fantom-X8). Use with other stands (or carts) is capable of resulting in instability causing possible injury. 
- Always grasp only the plug on the power-supply cord when plugging into, or unplugging from, an outlet or this unit. 
- At regular intervals, you should unplug the power plug and clean it by using a dry cloth to wipe all dust and other accumulations away from its prongs. Also, disconnect the power plug from the power outlet whenever the unit is to remain unused for an extended period of time. Any accumulation of dust between the power plug and the power outlet can result in poor insulation and lead to fire. 

⚠ CAUTION

- Try to prevent cords and cables from becoming entangled. Also, all cords and cables should be placed so they are out of the reach of children. 
- Never climb on top of, nor place heavy objects on the unit. 
- Never handle the power cord or its plugs with wet hands when plugging into, or unplugging from, an outlet or this unit. 
- Before moving the unit, disconnect the power plug from the outlet, and pull out all cords from external devices. 
- Before cleaning the unit, turn off the power and unplug the power cord from the outlet (p. 22). 
- Whenever you suspect the possibility of lightning in your area, pull the plug on the power cord out of the outlet. 
- Install only the specified circuit board(s) (SRX Series, DIMM). Remove only the specified screws (p. 240, p. 242, p. 244, p. 246, p. 248). 
- Should you remove the screws that fasten the bottom panel (the front panel of the Fantom-X8) or the PC card protector, be sure to place them out of children's reach, so there is no chance of them being swallowed accidentally. 

IMPORTANT NOTES

In addition to the items listed under “IMPORTANT SAFETY INSTRUCTIONS” and “USING THE UNIT SAFELY” on pages 2–4, please read and observe the following:

Power Supply

- Do not connect this unit to same electrical outlet that is being used by an electrical appliance that is controlled by an inverter (such as a refrigerator, washing machine, microwave oven, or air conditioner), or that contains a motor. Depending on the way in which the electrical appliance is used, power supply noise may cause this unit to malfunction or may produce audible noise. If it is not practical to use a separate electrical outlet, connect a power supply noise filter between this unit and the electrical outlet.
- Before connecting this unit to other devices, turn off the power to all units. This will help prevent malfunctions and/or damage to speakers or other devices.
- Although the LCD and LEDs are switched off when the POWER switch is switched off, this does not mean that the unit has been completely disconnected from the source of power. If you need to turn off the power completely, first turn off the POWER switch, then unplug the power cord from the power outlet. For this reason, the outlet into which you choose to connect the power cord's plug should be one that is within easy reach and readily accessible.

Placement

- Using the unit near power amplifiers (or other equipment containing large power transformers) may induce hum. To alleviate the problem, change the orientation of this unit; or move it farther away from the source of interference.
- This device may interfere with radio and television reception. Do not use this device in the vicinity of such receivers.
- Noise may be produced if wireless communications devices, such as cell phones, are operated in the vicinity of this unit. Such noise could occur when receiving or initiating a call, or while conversing. Should you experience such problems, you should relocate such wireless devices so they are at a greater distance from this unit, or switch them off.
- Do not expose the unit to direct sunlight, place it near devices that radiate heat, leave it inside an enclosed vehicle, or otherwise subject it to temperature extremes. Excessive heat can deform or discolor the unit.
- When moved from one location to another where the temperature and/or humidity is very different, water droplets (condensation) may form inside the unit. Damage or malfunction may result if you attempt to use the unit in this condition. Therefore, before using the unit, you must allow it to stand for several hours, until the condensation has completely evaporated.
- Do not allow objects to remain on top of the keyboard. This can be the cause of malfunction, such as keys ceasing to produce sound.

Maintenance

- For everyday cleaning wipe the unit with a soft, dry cloth or one that has been slightly dampened with water. To remove stubborn dirt, use a cloth impregnated with a mild, non-abrasive detergent. Afterwards, be sure to wipe the unit thoroughly with a soft, dry cloth.
- Never use benzine, thinners, alcohol or solvents of any kind, to avoid the possibility of discoloration and/or deformation.

Repairs and Data

- Please be aware that all data contained in the unit’s memory may be lost when the unit is sent for repairs. Important data should always be backed up on a memory card, or written down on paper (when possible). During repairs, due care is taken to avoid the loss of data. However, in certain cases (such as when circuitry related to memory itself is out of order), we regret that it may not be possible to restore the data, and Roland assumes no liability concerning such loss of data.

Additional Precautions

- Please be aware that the contents of memory can be irretrievably lost as a result of a malfunction, or the improper operation of the unit. To protect yourself against the risk of loosing important data, we recommend that you periodically save a backup copy of important data you have stored in the unit’s memory on a memory card, or other device.
- Unfortunately, it may be impossible to restore the contents of data that was stored on a memory card, unit’s memory, or other device once it has been lost. Roland Corporation assumes no liability concerning such loss of data.
- Use a reasonable amount of care when using the unit’s buttons, sliders, or other controls; and when using its jacks and connectors. Rough handling can lead to malfunctions.
- Never strike or apply strong pressure to the display.
- A small amount of noise may be heard from the display during normal operation.
- When connecting / disconnecting all cables, grasp the connector itself—never pull on the cable. This way you will avoid causing shorts, or damage to the cable’s internal elements.
- A small amount of heat will radiate from the unit during normal operation.
- To avoid disturbing your neighbors, try to keep the unit’s volume at reasonable levels. You may prefer to use headphones, so you do not need to be concerned about those around you (especially when it is late at night).
- When you need to transport the unit, package it in the box (including padding) that it came in, if possible. Otherwise, you will need to use equivalent packaging materials.
- Use only the specified expression pedal (EV-5; sold separately). By connecting any other expression pedals, you risk causing malfunction and/or damage to the unit.
- Use a cable from Roland to make the connection. If using some other make of connection cable, please note the following precautions.
 - Some connection cables contain resistors. Do not use cables that incorporate resistors for connecting to this unit. The use of such cables can cause the sound level to be extremely low, or impossible to hear. For information on cable specifications, contact the manufacturer of the cable.
- The sensitivity of the D Beam controller will change depending on the amount of light in the vicinity of the unit. If it does not function as you expect, adjust the sensitivity as appropriate for the brightness of your location. Increase this value will raise the sensitivity (p. 226).

Before Using Cards

Using Memory Cards

- Carefully insert the memory Card all the way in—until it is firmly in place.
- Never touch the terminals of the memory card. Also, avoid getting the terminals dirty.
- This unit’s memory card slot accepts CompactFlash, Smartmedia (3.3V).
- CompactFlash, Smartmedia (3.3V) are constructed using precision components; handle the cards carefully, paying particular note to the following.
 - To prevent damage to the cards from static electricity, be sure to discharge any static electricity from your own body before handling the cards.
 - Do not touch or allow metal to come into contact with the contact portion of the cards.
 - Do not bend, drop, or subject cards to strong shock or vibration.
 - Do not keep cards in direct sunlight, in closed vehicles, or other such locations (storage temperature: -25 to 85° C).
 - Do not allow cards to become wet.
 - Do not disassemble or modify the cards.

Handling CD-ROMs

- Avoid touching or scratching the shiny underside (encoded surface) of the disc. Damaged or dirty CD-ROM discs may not be read properly. Keep your discs clean using a commercially available CD cleaner.

Copyright

- Unauthorized recording, distribution, sale, lending, public performance, broadcasting, or the like, in whole or in part, of a work (musical composition, video, broadcast, public performance, or the like) whose copyright is held by a third party is prohibited by law.
- When exchanging audio signals through a digital connection with an external instrument, this unit can perform recording without being subject to the restrictions of the Serial Copy Management System (SCMS). This is because the unit is intended solely for musical production, and is designed not to be subject to restrictions as long as it is used to record works (such as your own compositions) that do not infringe on the copyrights of others. (SCMS is a feature that prohibits second-generation and later copying through a digital connection. It is built into MD recorders and other consumer digital-audio equipment as a copyright-protection feature.)
- Do not use this unit for purposes that could infringe on a copyright held by a third party. We assume no responsibility whatsoever with regard to any infringements of third-party copyrights arising through your use of this unit.

- * Microsoft and Windows are registered trademarks of Microsoft Corporation.
- * Windows® is known officially as: “Microsoft® Windows® operating system.”
- * Apple and Macintosh are registered trademark of Apple Computer, Inc.
- * MacOS is a trademark of Apple Computer, Inc.
- * Pentium is a registered trademark of Intel Corporation.
- * All product names mentioned in this document are trademarks or registered trademarks of their respective owners.
- * SmartMedia is a trademark of Toshiba Corp.
- * OMS is a registered trademark of Opcode Systems, Inc.

- * CompactFlash and  are trademarks of SanDisk Corporation and licensed by CompactFlash association.

- * Roland Corporation is an authorized licensee of the CompactFlash™ and CF logo () trademarks.

Contents

USING THE UNIT SAFELY	3
IMPORTANT NOTES	4
Main Features	15
Panel Descriptions	16
Front Panel.....	16
Rear Panel.....	18
Getting Ready	19
Connecting an Amp and Speaker System.....	19
Placing the Fantom-X8 on a Stand (For Fantom-X8 user)	20
Turning On the Power	21
Adjusting the Display Contrast (LCD Contrast).....	22
Turning Off the Power.....	22
Listening to the Demo Songs	23
Listening to the demo song loaded when you start up the Fantom-X	23
Listening to the other demo songs.....	23
Various Performance Features	24
Velocity / Aftertouch	24
Pitch Bend / Modulation Lever	24
Octave Shift (Oct)	24
Hold Pedal.....	24
Control Pedal	25
Transpose (Trans).....	25
Overview of the Fantom-X	26
How the Fantom-X Is Organized	26
Basic Structure	26
Classification of Fantom-X Sound Types.....	26
About Simultaneous Polyphony	28
About Memory.....	28
Temporary Memory.....	29
Rewritable Memory	29
Non-Rewritable Memory	29
About the Onboard Effects	29
Effect Types.....	29
How Effects Units Work in Different Modes	30
About the Sequencer	30
What Is a Song?	30
What Is a Track?	30
Songs and the Sound Generator Mode	31
Positions for Storing a Song.....	31
About the Sampling Section.....	32
Where Samples are Stored	32
Basic Operation of the Fantom-X	33
Switching the Sound Generator Mode.....	33
About the Function Buttons	34
Moving the Cursor	34
Modifying a Value	35
Assigning a Name.....	36
Registering and recalling frequently used screen pages (Bookmark)	37
Registering a page.....	37
Recalling a page.....	37
Viewing an explanation of each button (Help)	37
Viewing the number of voices used by the sound generator (Voice Monitor)	37

Playing in Patch Mode	38
About the Patch Play Screen	38
Displaying Patch Play Screen	38
Selecting a Patch	39
Selecting Patches by Category (Patch Finder)	40
Selecting Patches from the List.....	41
Auditioning Patches (Phrase Preview)	42
Creating a list of frequently used Patches and Performances (Live Setting).....	42
Recalling sounds	42
Registering a sound	43
Removing a registration.....	43
Removing all sound registrations from a bank	43
Changing the step at which a sound is registered	43
Selecting Favorite Patches (Favorite Patch).....	44
Registering a Favorite Patch	44
Registering Favorite Rhythm Sets	45
Transposing the Keyboard in Octave Units (Octave Shift)	45
Transposing the Keyboard in Semitone Steps (Transpose).....	46
Selecting the Tones That Will Sound (Tone On/Off).....	46
Playing Single Notes (Monophonic).....	46
Creating Smooth Pitch Changes (Portamento)	47
Selecting the Parameter Controlled by the Realtime Controllers or D Beam Controller (Control Setting)	47
Specifying the Part that Will be Affected by the Controller	47
Assigning a Parameter to a Controller.....	48
Playing Percussion Instruments.....	52
Selecting a Rhythm Set	52
Playing a Rhythm Set	53
Playing in Piano Mode	54
Selecting Piano Mode.....	54
Selecting a Patch	54
Selecting Patches by Category.....	54
Selecting from the Patch List Screen.....	54
Playing acoustic piano sounds	54
Adjusting the Keyboard Touch (Key Touch).....	54
Changing the Piano Sound (Open/Close)	55
Adjusting the Depth of Resonance (Resonance).....	55
Playing electric piano sounds	55
Selecting electric piano effects.....	55
Saving a Sound (Patch).....	55
Creating a Patch	56
How to Make Patch Settings.....	56
Editing in a Graphic Display (Zoom Edit)	57
Initializing Patch Settings (Init).....	57
Copying Patch (Tone) Settings (Copy).....	58
Cautions When Selecting a Waveform	58
Saving Patches You've Created (Write)	59
Auditioning the Save-Destination Patch (Compare)	60
Functions of Patch Parameters	60
Settings Common to the Entire Patch (General).....	60
Modifying Waveforms (Wave)	62
Changing How a Tone Is Sounded (TMT)	63
Modifying Pitch (Pitch/Pitch Env).....	67
Modifying the Brightness of a Sound with a Filter (TVF/TVF Env).....	69
Adjusting the Volume (TVA/TVA Env)	71

Output.....	73
Modulating Sounds (LFO).....	74
Apply Portamento or Legato to the Sound (Solo/Porta).....	77
Miscellaneous Settings (Misc).....	78
Matrix Control Settings (Ctrl1–4).....	80
Setting Effects for a Patch (Effects/MFX/MFX Control/Chorus/Reverb).....	82
Creating a Rhythm Set	83
How to make Rhythm Set settings.....	83
Editing in a Graphic Display (Zoom Edit).....	84
Initializing Rhythm Set Settings (Init).....	84
Copying Rhythm Tone Settings (Copy).....	84
Cautions When Selecting a Waveform.....	85
Saving Rhythm Sets You've Created (Write).....	86
Auditioning the Save-Destination Rhythm Set (Compare).....	86
Functions of Rhythm Set Parameters.....	87
Making Settings Common to the Entire Rhythm Set (General).....	87
Modifying Waveforms (Wave).....	88
Changing How a Rhythm Tone Is Sounded (WMT).....	89
Modifying Pitch (Pitch/Pitch Env).....	90
Modifying the Brightness of a Sound with a Filter (TVF/TVF Env).....	92
Adjusting the Volume (TVA/TVA Env).....	94
Output Settings (Output).....	95
Setting Effects for a Rhythm Set (Effects/MFX/MFX Control/Chorus/Reverb).....	96
Playing in Performance Mode	97
Displaying Performance Layer Screen.....	97
Displaying Performance Mixer Screen.....	97
Functions in the PERFORMANCE Layer/Mixer Screen.....	98
Selecting a Performance.....	99
Selecting Performances from the List.....	99
Creating a list of frequently used Patches and Performances (the Live Setting function).....	99
Selecting Favorite Performances.....	100
Registering a Favorite Performance.....	100
Using the Layer Screen.....	100
Selecting a Part.....	100
Selecting the Part that You want to Sound (Keyboard Switch).....	101
Selecting the Sound for a Part.....	101
Combining and Playing Sounds Together (Layer).....	102
Playing Different Sounds in Different Areas of the Keyboard (Split).....	102
Using the Mixer Screen.....	103
Selecting Parts for a Layer or Split.....	103
Selecting the Sound for a Part.....	103
Editing the Part Settings.....	104
Selecting a Part to Play Individually (Solo).....	105
Silencing the Playback of a Specific Part (Mute).....	105
Using pads to mute Parts.....	105
Viewing the Part Settings as a List (Performance Part View).....	106
Performing with the Arpeggio/Rhythm function.....	106
Performing with the Realtime Controllers and D Beam Controller.....	106
Viewing MIDI messages for each Part (Part Information).....	106
Viewing the number of voices used by the sound generator (Voice Monitor).....	106
Adjusting the Master Level.....	106

Creating a Performance	107
Viewing the Part Settings as a List (Performance Part View)	107
Adjusting the Parameters of Each Part	107
Selecting the Parameter Controlled by the Realtime Controllers or D Beam Controller (Control Setting)	114
Make Settings for the Realtime Controllers and D Beam Controller (Ctrl).....	114
Control Switch Settings (Ctrl Switch)	118
Changing the Settings of the Patch Assigned to a Part.....	119
Initializing Performance Settings (Init)	119
Saving a Performance You've Created (Write)	120
Modifying the Sound in Real Time	121
Waving Your Hand Over the D Beam to Modify the Sound (D Beam Controller)	121
Making Settings for the D Beam Controller	122
Using Knobs or Buttons to Modify the Sound (Realtime Controller)	124
Changing Realtime Controller Settings	125
Using a Pedal to Modify the Sound (Control Pedal).....	126
Making Control Pedal Settings	126
Playing Arpeggios	128
About Arpeggio	128
Playing Arpeggios	128
Turning Arpeggio On and Off	128
Determining the Tempo for Arpeggio Performances	128
Holding an Arpeggio.....	128
Playing Arpeggios Along with the Sequencer	129
Arpeggio Settings	129
Selecting Styles for Arpeggio Performances (Arpeggio Style).....	129
Changing the Beat and Shuffle (Arp/Rhythm Grid).....	129
Applying Staccato and Tenuto (Arp/Rhythm Duration)	130
Selecting Ascending/Descending Variations (Different Ways of Playing the Sounds) (Arp Motif)	130
Adjusting the Velocity of the Arpeggio (Arp Velocity).....	130
Selecting the Part that Will Play Arpeggios in Performance Mode (Arp Part).....	130
Changing the Accent Strength (Arp Accent)	130
Hanging the Range of the Arpeggio (Oct Range)	131
Using the Realtime Control Knobs to Edit the Arpeggio Settings.....	131
Creating an Arpeggio Style (Arpeggio Style Edit)	131
Step-recording	131
Using the Dial or [INC][DEC] to Input Values	132
Saving the Styles You Have Created (Write).....	132
Using the Chord Memory Function (Chord Memory)	133
About the Chord Memory Function.....	133
Performing with the Chord Memory Function.....	133
Turning Chord Memory Function On and Off.....	133
Selecting Chord Forms	133
Sounding a chord in the order of its notes (Rolled Chord).....	134
Creating Your Own Chord Forms	134
Saving the Chord Forms You Have Created	134

Playing Rhythms	135
About Rhythm Patterns.....	135
Using Rhythm Groups.....	135
Playing Rhythm	135
Turning Rhythm On and Off.....	135
Determining the Tempo for Rhythm Pattern Performances	135
Select the Rhythm Group.....	136
Rhythm Pattern Settings.....	136
Selecting Rhythm Patterns.....	136
Changing the Beat and Shuffle (Grid).....	137
Applying Staccato and Tenuity (Duration).....	137
Changing the velocity of Rhythm Pattern (Rhythm Pattern Velocity)	137
Changing the Accent Strength (Rhythm Accent).....	137
Using the Realtime Control Knobs to Control the Rhythm	137
Creating an Rhythm Pattern (Rhythm Pattern Edit).....	138
Step-recording	138
Using the Dial or [INC][DEC] to Input Values.....	138
Saving the Patterns You Have Created (Write)	139
Creating Your Own Styles (Rhythm Group Edit).....	139
Saving the Rhythm Group You Have Created (Write).....	140
Sampling	141
Switching external input on/off.....	141
Making Input Source Settings (Input Setting).....	141
Input Effect Setup Settings.....	142
Sampling Procedure.....	142
Dividing a Sample During Sampling	144
Sampling Earlier in Time (Skip Back Sampling).....	145
Editing a Sample.....	146
Selecting a Sample (Sample List).....	146
Selecting a Sample.....	146
Loading a Sample.....	147
Loading all Samples.....	147
Unloading a Sample.....	147
Deleting a Sample	147
Importing an Audio File	148
Displaying Sample Edit Screen	148
Magnifying/Shrinking the Waveform Display (Zoom In/Out).....	148
Setting the Start/End Points of the Sample.....	149
Using the knobs to edit the points	149
Making Settings for Sample (Sample Parameters)	150
Assigning Samples to a Pad (Assign To Pad)	151
From Patch Mode.....	151
From Performance Mode	151
Assigning a Sample as a Patch to a Part (Assign to Keyboard).....	152
From Patch Mode.....	152
From Performance Mode	152
Create a Rhythm Set (Create Rhythm)	152
Creating a Multisample (Create Multisample)	153
Unloading a Sample (Unload).....	155
Removing Unwanted Portions of a Sample (Truncate)	155
Boosting or Limiting the High-frequency Range of the Sample (Emphasis)	155
Maximizing the Volume of a Sample (Normalize).....	156
Amp.....	156
Stretching or Shrinking a Sample (Time Stretch).....	156
Dividing a Sample into Notes (Chop)	157
Joining Two or More Samples (Combine)	158
Saving a Sample.....	159

Using the Pads.....	160
Using the Hold Function to Sustain a Sound	160
Using the Roll Function to Play Sounds.....	160
Making Settings for the Pads (Pad Setting)	161
Specify the Currently Used Sound Generator	161
Settings You Can Make for Each Pad.....	161
Settings that Apply to All Pads.....	161
Writing the Pad Settings	162
Exchanging the Sound of Two Pads (Pad Exchange)	162
Assigning a Pattern to a Pad (RPS Function)	163
Using the Pads to Play Rhythms	163
Playing Back a Song	164
Playing a Song Immediately (Quick Play).....	164
Playing Back Songs Consecutively (Chain Play)	164
Various Playback Methods	165
Fast-Forward and Rewind During Playback	165
Playing Back Correctly from the Middle of the Song (MIDI Update).....	165
Muting the Playback of a Specific Instrument.....	165
Changing the Playback Tempo of a Song.....	166
Playing a Song Back at a Fixed Tempo (Muting the Tempo Track)	166
Playing Back a S-MRC Format Song	166
Playing Back a Song Repeatedly (Loop Play)	166
Using the D Beam Controller to Start/Stop Song Playback	167
Recording Songs	168
Two Recording Methods.....	168
Before You Record a New Song	168
Select the Sound to be Used for Recording	168
Erasing the Song/Pattern from Temporary Song (Song Clear)	168
Specify the Time Signature	169
Setting the tempo	169
Recording Your Performance as You Play It (Realtime Recording)	170
Basic Operation for Realtime Recording	170
Recording Tempo Changes in a Song (Tempo Recording).....	171
Loop Recording and Punch-In Recording.....	171
Correct the Timing of Your Playing as You Record (Recording Quantize)	172
Selecting the Sequencer Data that will Be Recorded (Recording Select)	172
Erasing Unwanted Data While You Record (Realtime Erase).....	173
Recording Arpeggios Aligned to the Measures of the Sequencer	173
Auditioning Sounds or Phrases While Recording (Rehearsal Function).....	173
Inputting Data One Step at a Time (Step Recording).....	174
Inputting Notes and Rests	174
Assigning a Pattern to a Phrase Track	176
Editing Songs	177
Loading the Song You Want to Edit	177
Viewing the data within a track.....	178
Using Different Sound Generators for Each Track	178
Loading Individual Tracks/Patterns of Song Data.....	178
Silencing the Playback of a Track (Mute)	178
Assigning Markers (Locate Positions) to a Song	179
Specifying the Area of a Song that will Repeat (Loop Points).....	179
Editing Sequencer Data Over the Specified Range (Track Edit)	180
Basic Operation for Track Editing	180
Aligning a Song's Timing (Quantize)	181
Erasing Unwanted Performance Data (Erase)	183
Deleting Unwanted Measures (Delete).....	184
Copying Phrases (Copy)	184

Inserting a Blank Measure (Insert)	185
Transpose the Key (Transpose).....	185
Changing the Velocity (Volume) (Change Velocity)	186
Changing the MIDI Channel (Change Channel)	186
Modifying the Length of Notes (Change Duration)	187
Combining Two Phrase Tracks or Patterns into One (Merge)	188
Extracting and Moving a Part of Sequencer Data (Extract)	188
Shifting Performance Data Forward and Back (Shift Clock)	189
Thinning Out the Sequencer Data (Data Thin)	190
Swapping Two Phrase Tracks or Patterns (Exchange).....	191
Adjusting the Song's Playback Time (Time Fit)	191
Deleting Blank Measures (Truncate).....	191
Editing Individual Items of Sequencer Data (Micro Edit).....	192
Editing Sequencer Data (Basic Procedure in the Microscope).....	192
Sequencer Data Handled by a Phrase Track/Pattern.....	193
Viewing Sequencer Data (View)	194
Inserting Sequencer Data (Create).....	194
Erasing Sequencer Data (Erase)	195
Moving Sequencer Data (Move)	195
Copying Sequencer Data (Copy)	195
Changing the Tempo Midway Through the Song	196
Changing the Time Signature Midway Through the Song.....	196
Assigning a Name to a Song (Song Name).....	197
Saving/Loading a song (Save/Load).....	198
Saving a Song (Save)	198
Basic Procedure	198
Data saved together with a song.....	198
Saving a Song with Samples (Save Song+Samples).....	199
Saving a Song (Save Song).....	199
Saving Samples (Save All Samples).....	200
Saving a Song as an SMF File (Save as SMF).....	200
Loading a Song (Load).....	201
Basic Procedure	201
Loading a Song with Samples (Load Song+Samples)	201
Loading a song (Load Song).....	202
Loading Samples (Load All Samples).....	202
Importing a WAV/AIFF File (Import Audio).....	202
Playing a Phrase at the Touch of a Finger (RPS Function).....	203
Before You Use the RPS Function	203
Record a Pattern	203
Settings for the RPS Function.....	203
Using the RPS Function While You Perform.....	204
Recording a Performance Using the RPS Function.....	205
Adding Effects	206
Turning Effects On and Off.....	206
Making Effect Settings	206
Applying Effects in Patch Mode	207
Specifying How the Sound Will Be Output (Routing)	207
Signal Flow Diagram and Parameters	207
Applying Effects in Performance Mode.....	210
Specifying How the Sound Will Be Output (Routing)	210
Signal Flow Diagram and Parameters	210
Making Multi-Effects Settings (MFX1-3).....	213
Making Multi-Effects Settings (MFX Control)	213
Specifying the multi-effect structure (MFX Structure).....	215
Making Chorus Settings (Chorus)	215

Making Reverb Settings (Reverb)	216
Mastering Effect.....	217
Connecting to Your Computer via USB (USB Mode)	218
About USB Functions.....	218
Switching the Storage Mode and the MIDI Mode.....	218
Transferring Files to or from Your Computer (Storage Mode)	219
Exchanging MIDI Messages with Your Computer (MIDI Mode).....	222
File-Related Functions (File Utility).....	223
Basic Procedure.....	223
Copying a File (Copy).....	224
Deleting a File (Delete)	224
Moving a File (Move).....	224
Initializing a Memory Card (Card Format)	224
Settings Common to All Modes (System Function)	225
How to Make System Function Settings	225
Saving the System Settings (System Write)	225
Functions of System Parameters	226
Pedal/D Beam	226
Keyboard	226
Sync/Temp	227
Metronome.....	228
Sound	229
MIDI.....	230
USB.....	231
Scale Tune.....	232
Preview	232
System Ctrl.....	233
Background.....	233
Screen Saver	233
Sampling.....	233
Start up.....	234
System Information.....	234
Data Management Functions	
Reset to Default Factory Settings (Factory Reset).....	235
Basic Procedure.....	235
Backing Up User Data (User Backup)	235
Restoring User Data that You Backed Up (User Restore)	235
Factory Reset	235
Using Fantom-X Editor.....	236
Installing Fantom-X Editor into Your Computer.....	236
Making Connections	236
Using Fantom-X Librarian	236
Fantom-X Editor System Requirements.....	237
System Requirements (Windows)	237
System Requirements (Mac OS).....	237
About V-LINK	238
What is V-LINK?	238
Connection Examples	238
Turning the V-LINK ON/OFF	238
V-LINK Settings.....	238
V-LINK Parameters	239
Resetting the Image.....	239

Installing the Wave Expansion Board.....	240
Cautions When Installing an Wave Expansion Board	240
How to Install a Wave Expansion Board	240
Checking the Installed Wave Expansion Boards	241
Installation de la carte d'expansion Wave	242
Précautions à prendre lors de l'installation d'une carte d'expansion Wave	242
Installation d'une carte d'expansion Wave	242
Vérification des cartes d'extension audio après installation.....	243
Expanding the Memory	244
Precautions for Expanding Memory	244
How to Expand the Memory	244
Removing the Memory.....	245
Checking that memory is installed correctly.....	245
Ajouter de la mémoire.....	246
Précautions à prendre lors de l'ajout de mémoire.....	246
Installation du module de mémoire	246
Retrait du module de mémoire	247
Vérifier que la mémoire est installée correctement	247
Using a Memory Card.....	248
Before Using the Memory Card	248
Writing data to the card.....	248
Installing the PC Card Protector	248
Troubleshooting	249
Problems Concerning the Entire Phantom-X	249
Issues Related to Sound	249
Issues Related to Effects	251
Issues Related to Saving Data	251
Issues Related to Sequencer.....	252
Issues Related to MIDI and External Devices	253
Issues Related to Sampling	254
Issues Related to a Memory Card	254
Parameter List.....	255
Patch Parameter.....	255
Rhythm Set Parameter	259
Performance Parameter	262
Rhythm Group Parameter.....	265
Sample Parameters.....	265
System Parameters	266
Effects List	270
Multi-Effects Parameter.....	270
Chorus Parameters	293
Reverb Parameters	294
Input Effect Parameters	294
Error Messages.....	296
About MIDI.....	297
About MIDI Connectors.....	297
MIDI Channels and Multi-timbral Sound Generators.....	297
MIDI Implementation	298
Specifications	333
Index	335

Main Features

Cutting-edge sound engine that unifies audio and MIDI

The Fantom-X inherits the same sound engine that was acclaimed on the Fantom-S, unifying synthesizer and sampler into a single sound generator. Sampled waveforms and waveforms imported from a PC or other external source can also be used as synthesizer waveforms. In addition to the internal sounds and sampled waveforms, you can install up to four SRX-series wave expansion boards for instant access to an even broader range of sounds.

Top-class 128-voice polyphony

An ample 128 voices of polyphony guarantees stress-free music production or live performance.

Highest quality 88-note multisampled piano waveforms

The Fantom-X features an 88-note multisampled piano painstakingly recorded by professional engineers. Every note has been sampled in stereo with four velocity-switched layers, meaning that a lavish 704 samples are used to create this piano sound. It boasts not only tonal quality but also a high level of presence, making it closer than ever to the "real thing."

The 128 MB of internal waveform memory is double that of the Fantom-S series. It adds a wide range of sounds created with an emphasis on quality, including strings, nylon string guitar, drums, and bass, as well as piano.

* 88-note multisampling is used only for the piano waveform.

Large, color LCD—first ever on a synthesizer!

A large, color LCD is used for excellent visibility and user-friendliness.

With a fresh new appearance, it opens a new era in user interfaces.

Full-fledged sampler

In addition to sampling and resampling functionality, waveform editing is also provided, delivering functionality that rivals dedicated samplers. There's also an Auto Sync function that can automatically match the length of a measure to the current tempo. 32 MB of sampling memory is provided as standard, and you can install expansion DIMM modules to expand this to as much as 544 MB.

Skip Back Sampling

The Skip Back Sampling function that was so popular on the Fantom-S series is also featured on the Fantom-X.

This function continually records whatever you play on the Fantom-X. Then, when you happen to come up with an inspired riff, simply press a single button to capture it.

Piano mode and Live Setting function

Piano mode lets you use the Fantom-X as a dedicated piano simply by pressing one button. The Live Setting function provides recall of live performance setups, guaranteeing smooth transitions between songs in your set.

A full complement of interfaces

USB connector for connection to your computer

USB-MIDI support allows data to be exchanged with your computer, and also makes it easy to connect with PC tools.

For connection to audio devices, both analog and digital input and output are provided as standard. When sampling, you can select either analog or digital as the source.

There's also a PC card slot for backing up your data. This allows you a broad choice of media including SmartMedia and Compact Flash, and since media capacities up to 1 GB are supported (when using Compact Flash), you have great flexibility in data transfer.

Built-in 16-track sequencer

A high-resolution 16-track sequencer is built in. With functions like Loop recording that lets you record each part non-stop, it's designed not to interfere with your creative imagination. After you've input your data, you can take advantage of the large LCD to edit track data graphically.

Dynamic pad bank

The Fantom-X features a dynamic pad bank that is sensitive to velocity and aftertouch. They can be used as trigger pads to play favorite sounds like hits or bass sounds, to recall RPS sequence phrases, or assigned to play skip back-sampled phrases. In another idea, rhythm sounds that were "chopped" from a loop phrase can be assigned to the pads and played for realtime input into the sequencer.

Mastering functionality

78 different multi-effects, chorus, and reverb are provided. Since the mastering effects that are indispensable as the final step of the music production process are also provided, you can create songs with a level of quality that approaches a commercially released CD.

V-LINK functionality

V-LINK lets you synchronize music and images to create completely new forms of expression. Realtime controllers such as the D Beam controller and the dynamic pads can be used to control images while you perform music.

Fantom-X Editor/Librarian included

The included editor and librarian software lets you edit and manage Fantom-X sounds from your computer.

Panel Descriptions

Front Panel

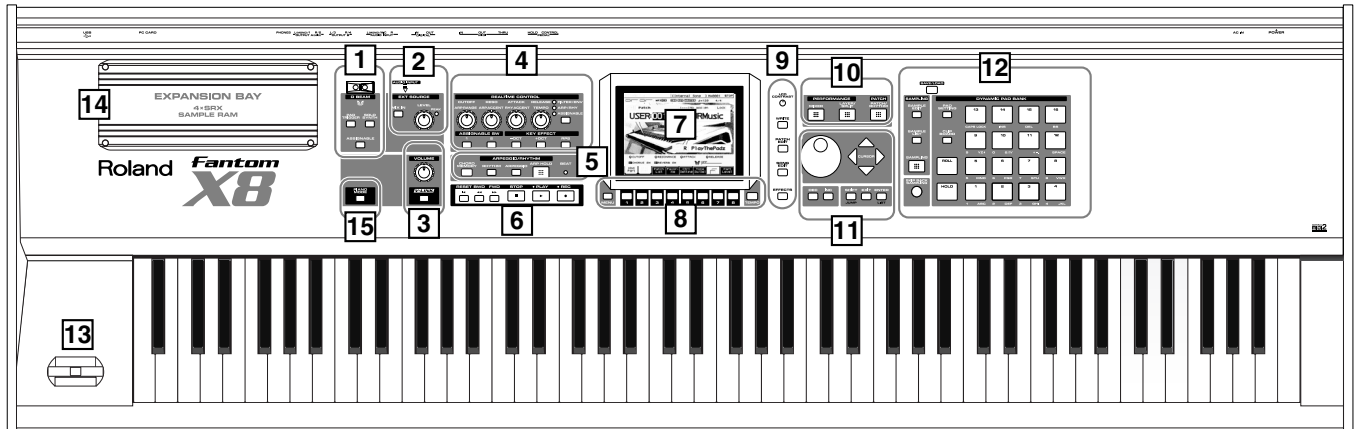

1 D BEAM D BEAM

Switches D Beam function on/off. You can apply a variety of effects to sounds simply by moving your hand. -> (p. 121)

[ASSIGNABLE]

You can assign a variety of parameters and functions to D Beam to modify the sound in realtime. -> (p. 122)

[PAD TRIGGER]

Instead of striking the pads themselves, you can also use the D Beam controller to control the sounding of the pads. -> (p. 122)

[SOLO SYNTH]

Play the Fantom-X as a monophonic synthesizer. -> (p. 123)

- * Hold down [SHIFT] and press one of the corresponding buttons to access the D BEAM setting screen.

2 EXT SOURCE

[MIX IN]

Switches the external input on/off. -> (p. 141)

- * Hold down [SHIFT] and press this button to access the external source setting screen.

LEVEL knob

Controls the volume of the external input.

PEAK indicator

This will light when the volume of the external input is too high.

3 VOLUME / V-LINK

VOLUME

Adjusts the overall volume that is output from the rear panel OUTPUT A (MIX) jacks and PHONES jack. -> (p. 21)

[V-LINK]

Switches the V-LINK function on/off. -> (p. 238)

- * Hold down [SHIFT] and press [V-LINK] to access the V-LINK setting screen.

4 REALTIME CONTROL

[] REALTIME CONTROL knob

Depending on the parameter or function that is assigned, you can use the knobs to modify the sound in realtime. -> (p. 47)

[], [] ASSIGNABLE switch

You can assign a variety of parameters and functions to these two buttons. Use them to switch the parameters and functions to modify the sound in realtime. -> (p. 122)

[RPS]

Switches RPS on/off. -> (p. 203)

- * Hold down [SHIFT] and press (or rotate) one of the above switches (or knob) to access the corresponding setting screen.

[-OCT], [+OCT]

Transposes the pitch of the keyboard in 1 octave units (-3- +3 octaves).

5 ARPEGGIO / RHYTHM

[CHORD MEMORY]

Switches the CHORD MEMORY on/off. -> (p. 133)

[RHYTHM]

Switches the RHYTHM on/off. -> (p. 135)

[ARPEGGIO]

Switches the ARPEGGIO on/off. -> (p. 128)

- * Hold down [SHIFT] and press one of the corresponding buttons to access CHORD MEMORY, RHYTHM or ARPEGGIO settings screen.

[ARP HOLD]

Switches the Arpeggio Hold function on/off.

BEAT (Beat Indicator)

This blinks in sync with the tempo and beat.

6 SEQUENCER

Perform sequencer operations such as playback and record.

[RESET]

Moves the song position to the top. If you press this during playback, you will return to the beginning of the song and stop. -> (p. 165)

[BWD]

Moves the song position to the first beat of the previous measure. -> (p. 165)

[FWD]

Moves the song position to the first beat of the next measure. -> (p. 165)

[Play]

Controls sequencer play.

[STOP]

Controls sequencer stop.

While stopped, you can hold down [SHIFT] and Press [PLAY] to perform MIDI Update. -> (p. 165)

[REC]

The display changes to the Recording Standby window. -> (p. 170)

If you press this during recording, the Rehearsal function will be activated. -> (p. 173)

7 DISPLAY

Display

This displays information regarding the operation you are performing

8

[MENU]

Opens the MENU. The contents of the menu will depend on the current mode.

Function buttons ([F1]–[F8])

During editing, these buttons execute a variety of functions, and their function will differ depending on the screen.

[TEMPO]

Sets the tempo (BPM). -> (p. 128, p. 135, p. 166)

9

LCD CONTRAST knob

Adjusts the display contrast. -> (p. 22)

[WRITE]

Save edited settings into Temporary Area or a memory card. -> (p. 59, p. 86, p. 120, p. 132, p. 134, p. 159, p. 198, p. 225)

[PATCH EDIT]

Make patch-related settings.

[SONG EDIT]

Make settings for song data and song edit. -> (p. 164)

[EFFECTS]

Make effect-related settings. Here you can also make mastering settings. -> (p. 206)

10

[MIXER]

View the Performance mode's Mixer screen. -> (p. 103)

[LAYER/SPLIT]

View the Performance mode's Layer screen. -> (p. 100)

[PATCH/RHYTHM]

Enter Patch/Rhythm mode. -> (p. 38)

11

VALUE Dial

This is used to modify values. If you hold down [SHIFT] as you turn the VALUE dial, the value will change in greater increments.

[DEC], [INC]

This is used to modify values. If you keep on holding down one button while pressing the other, the value change accelerates. If you press one of these buttons while holding down [SHIFT], the value will change in bigger increments.

[CURSOR]

Moves the cursor location up/down/left/right.

[SHIFT] (JUMP)

This button is used in conjunction with other buttons to execute various functions.

[ENTER]

Use this button to execute an operation.

[EXIT]

Return to the previous screen, or close the currently open window.

In some screens, this causes the currently executing function to be aborted.

12 DYNAMIC PAD / SAMPLING

[SAMPLE EDIT]

Edit a sample. -> (p. 148)

[SAMPLE LIST]

View the sample list. -> (p. 146)

[SAMPLING]

View the Sampling Menu screen. -> (p. 142)

[SKIP BACK SAMPLING]

Sample the performance for a specified duration prior to the moment you pressed the button. -> (p. 145)

[PAD SETTING]

Make pad settings. -> (p. 160)

[CLIP BOARD]

You can register frequently used screens and use the pads to recall them (the Bookmark function). -> (p. 37)

[SAVE/LOAD]

Saves/loads data in the Temporary Area (p. 29) or sample memory (p. 32) to/from user memory or a memory card.

[PAD 1–16]

Use as a keyboard to play sound.

[ROLL]

Turn "roll" playback on/off. -> (p. 160)

[HOLD]

Turn "hold" (sustaining the sound after you release the pad) on/off. ->(p. 160)

13

Pitch Bend/Modulation Lever

This allows you to control pitch bend or apply vibrato.

14

Here you can install a wave expansion board (SRX series; sold separately) or install separately sold memory (DIMM).

On the Fantom-X6/X7, this is located on the bottom panel. -> (p. 240, p. 242)

15

[PIANO MODE]

Switches to a special mode optimal for playing piano sounds. If you press this button while holding down [SHIFT], the Live Setting Play screen will appear. -> (p. 54)

Panel Descriptions

Rear Panel

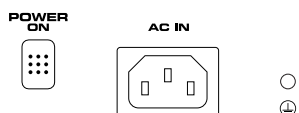

POWER ON Switch

Press to turn the power on/off. -> (p. 21, p. 22)

AC Inlet

Connect the included power cord to this inlet. -> (p. 21)



CTL (CONTROL) PEDAL Jack

You can connect optional expression pedals (EV-5, etc.) to these jacks. By assigning a desired function to a pedal, you can use it to select or modify sound or perform various other control. You can also connect optional pedal switches (DP series etc.) to sustain sound. -> (p. 25)

- * Use only the specified expression pedal (EV-5; sold separately). By connecting any other expression pedals, you risk causing malfunction and/or damage to the unit.

HOLD PEDAL Jack

An optional pedal switch (DP series etc.) can be connected to this jack for use as a hold pedal. -> (p. 24)

This can also be set so it supports the use of half-pedaling techniques. So, after connecting an optional expression pedal (DP-8, etc.), you can employ pedal work to achieve even finer control in performances in which piano tones are used.

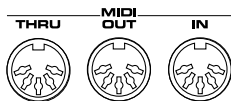

MIDI Connectors (IN, OUT, THRU)

These connectors can be connected to other MIDI devices to receive and transmit MIDI messages.



DIGITAL IN/OUT Connectors (S/P DIF COAXIAL)

These are coaxial-type S/P DIF format digital in/out connectors. These connectors input and output a digital audio signal (stereo). The output signal is identical to the signal that is output from the OUTPUT A (MIX) jacks.

- * S/P DIF is a digital interface format used for consumer digital audio devices.

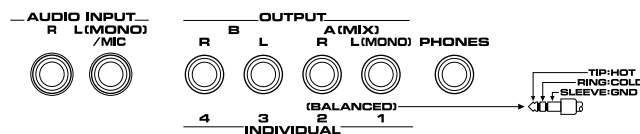

OUTPUT A (MIX) Jacks (L (MONO), R)

These jacks output the audio signal to the connected mixer/amplifier system in stereo. For mono output, use the L jack. -> (p. 19)

OUTPUT B Jacks (L, R)

These jacks output the audio signal to the connected mixer/amplifier system in stereo.

INDIVIDUAL 1-4 Jacks

These jacks output audio signals in mono to an amp or mixer.

The setting determining whether these jacks are used as stereo OUTPUT jacks or monaural INDIVIDUAL jacks is made with the Output Assign setting (p. 207).

AUDIO INPUT Jack (L, R)

Accept input of audio signals in stereo (L/R) from external devices. If you want to use mono input, connect to the L jack.

When recording from a mic, connect it to the L jack, and set Input Select (p. 141) to "MICROPHONE."

PHONES Jack

This is the jack for connecting headphones (sold separately). -> (p. 19)

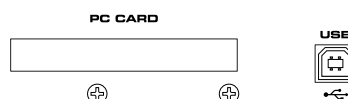

PC CARD Slot

A memory card can be inserted here. -> (p. 244, p. 246)

- * Carefully insert the memory card all the way in-until it is firmly in place.

USB Connector

This connector lets you use a USB cable to connect your computer to the Fantom-X. -> (p. 218)

Getting Ready

Connecting an Amp and Speaker System

Since the Fantom-X contains no amplifier or speakers, you'll need to connect it to audio equipment such as a keyboard amplifier, monitor speaker system or home stereo, or use headphones to hear its sound.

1. Before hooking anything up, make sure that the power on all of your gear is turned OFF.
2. Connect one end of the supplied power cable to the Fantom-X, and the other end to a power outlet.
3. Connect the Fantom-X to your amp/speaker system as shown in the diagram.

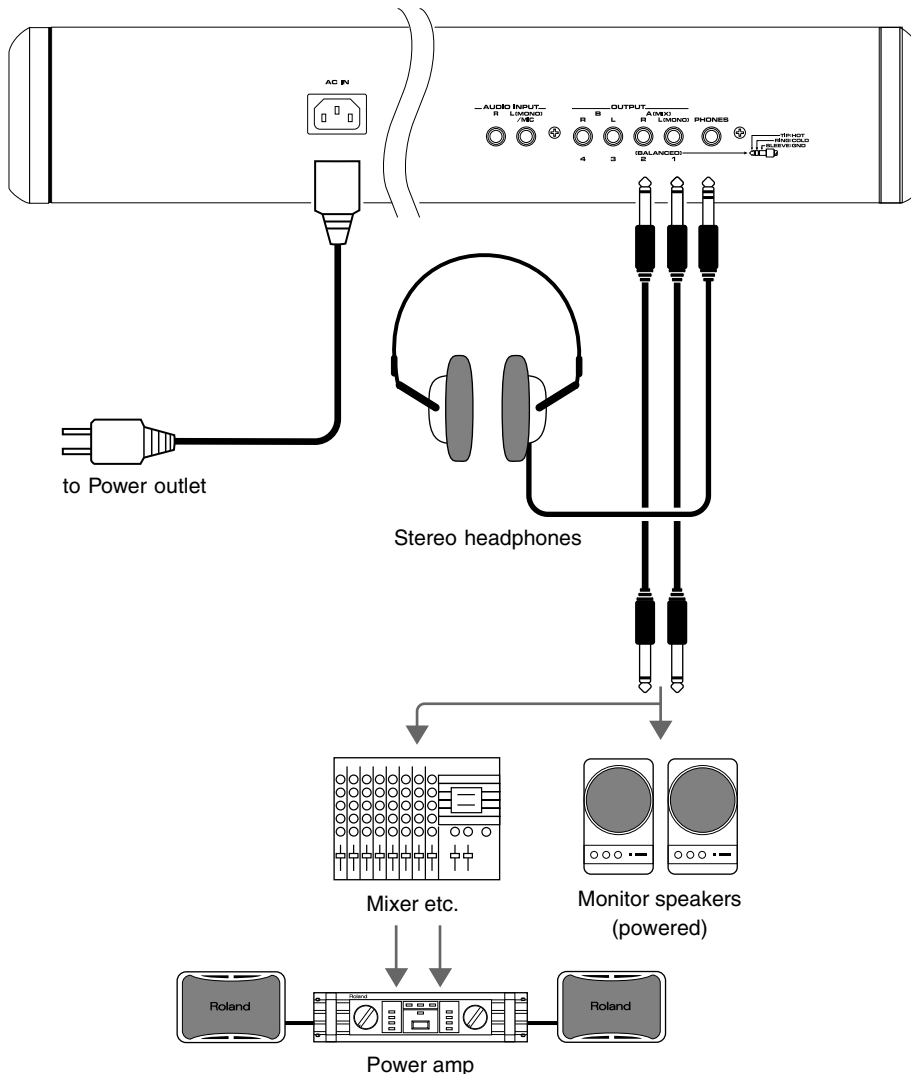

NOTE

To prevent malfunction and/or damage to speakers or other devices, always turn down the volume, and turn off the power on all devices before making any connections.

HINT

In order to fully experience the Fantom-X's sound, we recommend using a stereo amp/speaker system. If you're using a mono system, however, make your connections to the Fantom-X's OUTPUT A (MIX) jack L (MONO).

NOTE

Audio cables are not included with the Fantom-X. You'll need to provide them.



For details on how to install a Wave Expansion Board (sold separately), refer to "Installing the Wave Expansion Board" (p. 240).

MEMO

The OUTPUT A [MIX] jacks support balanced output. Use a correctly wired cable so that the HOT, COLD, and GND as printed on the rear panel of the Fantom-X are correct for the mixer or other input device you're using.

Placing the Fantom-X8 on a Stand (For Fantom-X8 user)

If you want to place the Fantom-X8 on a stand, use the Roland KS-17. Place the instrument on the stand as follows.

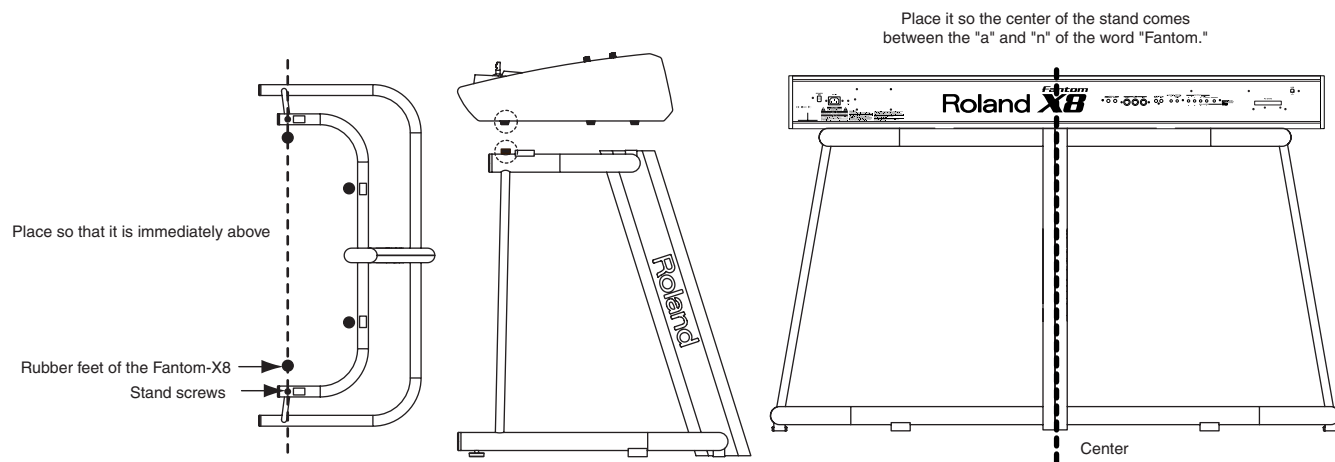

Turning On the Power

Once the connections have been completed (p. 19), turn on power to your various devices in the order specified. By turning on devices in the wrong order, you risk causing malfunction and/or damage to speakers and other devices.

1. **Before turning on the Fantom's power, consider these two questions:**
 - Are all peripheral devices connected correctly?
 - Have the volume controls of the Fantom-X and all connected audio devices been turned to their lowest settings?
2. **Turn on the POWER ON switch located on the rear panel of the Fantom-X.**

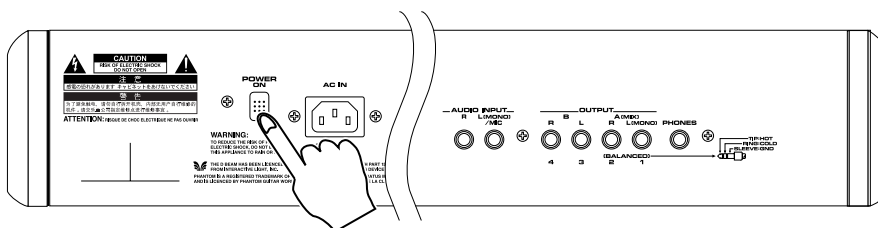

* This unit is equipped with a protection circuit. A brief interval (a few seconds) after power up is required before the unit will operate normally.

3. **Turn on the power for any connected amplifiers or speakers.**
4. **Play the Fantom-X's keyboard, gradually increasing the setting of its volume control, and then carefully raise the volume of your connected amplifiers or speakers to the desired listening level.**

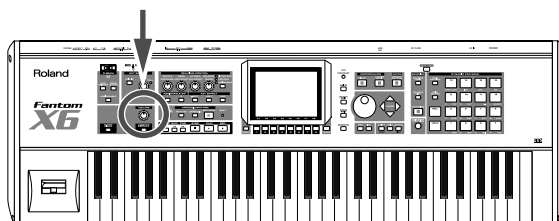

NOTE

To ensure proper operation of the pitch bend lever, make sure not to touch the lever when turning the Fantom-X's power on.



Do not touch!

NOTE

Be careful not to set your listening volume too high to avoid damage to your amp/speaker system or your hearing.

Adjusting the Display Contrast (LCD Contrast)

The characters in the display may be difficult to view immediately after turning on the Fantom-X's power or after extended use. Your viewing angle or the current lighting conditions can also affect the appearance of the display. In such situations, you can turn the CONTRAST knob (located on the rear panel) to adjust the contrast of the display.

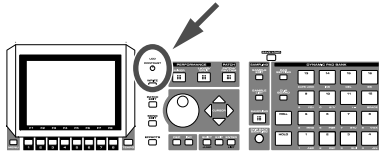

Turning Off the Power

- 1. Before you turn off the power, consider these two questions:**
 - Have the volume controls for the Fantom-X and all connected audio devices been turned to their lowest settings?
 - Have you saved your Fantom-X sounds or other data you've created?
- 2. Turn off the power for all connected audio devices.**
- 3. Turn off the POWER ON switch of the Fantom-X.**

NOTE

If you need to turn off the power completely, first turn off the POWER switch, then unplug the power cord from the power outlet. Refer to "Power Supply" (p. 4).

Listening to the Demo Songs

The Fantom-X contains a demonstration (“demo”) song that you can listen to using the Fantom-X’s Demo Play feature. The demo will introduce you to the Fantom-X’s exceptional sounds and effects.

Listening to the demo song loaded when you start up the Fantom-X

With the factory settings, you can play a song simply by powering up the Fantom-X and pressing the [PLAY] button.

Song name: Still Solace Copyright©Roland Corporation

This song is an acoustic piano and acoustic guitar performance. Either sound is ideal for both soloing and accompaniment.



MEMO

You can use the Song Edit screen to view the musical data of this song.

NOTE

All rights reserved. Unauthorized use of this material for purposes other than private, personal enjoyment is a violation of applicable laws.

Listening to the other demo songs

If you want to hear the other songs, use the following procedure to play them. For the names and copyright information of these songs, refer to the Fantom-X’s display.

1. Press [MENU].

The pull-down menu appears.

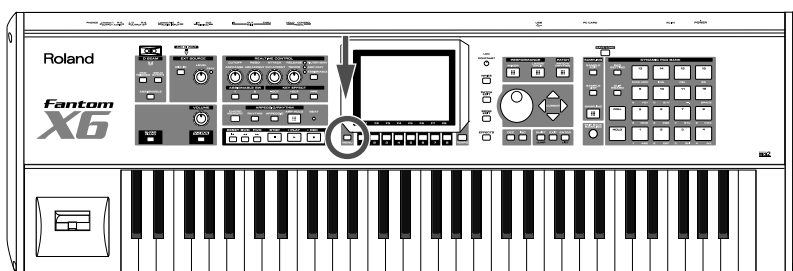

2. Press ▼ to select a “Demo Play,” and then press [ENTER].

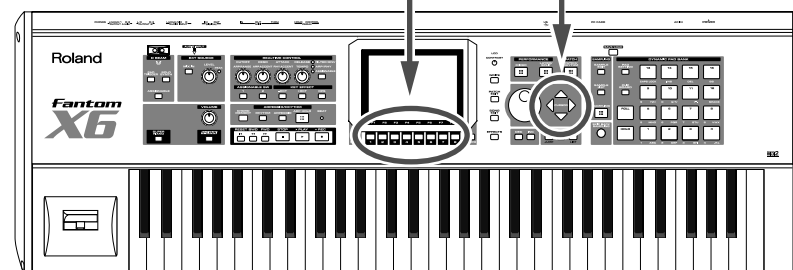

3. Press [F1 (SONG1)]-[F7 (SONG7)] to start demo song playback.

Otherwise, playback will stop automatically when the song ends. If you press [F8 (All Songs)], the songs will playback successively, beginning from the first.

4. Press [F8 (Exit)] to return to the Demo Menu screen.

5. Press [EXIT] to return to the previous screen.

* When you play back using the procedure of steps 1–5, the playback data will not be transmitted from the MIDI OUT connector.

NOTE

When you perform demo playback, any patch or performance you may have been editing will be lost.

Various Performance Features

Velocity/Aftertouch

The force with which you play the keyboard, or the “velocity” with which you play, can affect the volume or timbre of a sound. Aftertouch—downward pressure you apply to a key after playing a note—can also affect the sound.



For details on the setting, refer to p. 226.

MEMO

There are two types of aftertouch: Polyphonic Aftertouch, which applies aftertouch to individual notes, and Channel Aftertouch, which applies aftertouch to an entire MIDI channel (p. 193). The Fantom-X can output the MIDI data for Polyphonic Aftertouch using the pads, and Channel Aftertouch using the keyboard.

Pitch Bend/Modulation Lever

While playing the keyboard, move the lever to the left to lower the pitch of the currently selected patch, or to the right to raise its pitch. This is known as **pitch bend**. You can also apply vibrato by gently pushing the lever away from you. This is known as **modulation**.

If you push the lever away from you and at the same time move it to the right or left, you can apply both effects at once.

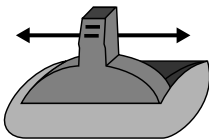

Pitch Bend

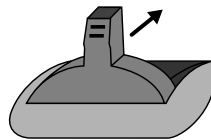

Modulation

MEMO

You can set the amount of pitch change for each patch (p. 67).

Octave Shift (Oct)

You can shift the pitch of the keyboard in one-octave units over a range of +/-3 octaves by adjusting the value of the Octave Shift parameter.

Use KEY EFFECT [-OCT] or [+OCT] at the left of the screen to make the desired setting.

To return to the original setting, press both buttons simultaneously.

Hold Pedal

If an optional pedal switch (DP series) is connected to the rear panel PEDAL HOLD jack, you can press the pedal switch to cause notes to sustain or “hold” even after their keys have been released.

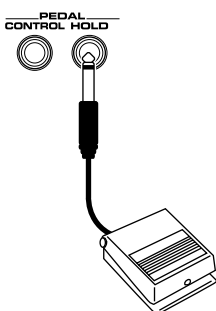

For details on the setting, refer to p. 226.

Control Pedal

If an optional expression pedal or pedal switch (EV-5, DP-2.) is connected to the rear panel PEDAL CONTROL jack, you can use the pedal to control the volume or various function.

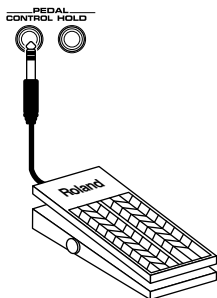

Transpose (Trans)

You can transpose the pitch of the keyboard in semitone steps, over a range of G-F# (-5- +6 semitones) by adjusting the Transpose parameter's value.

Press [CURSOR] to move the cursor to "Trans" in the upper part of the screen, and turn the VALUE dial or press [INC] or [DEC] to change its setting.

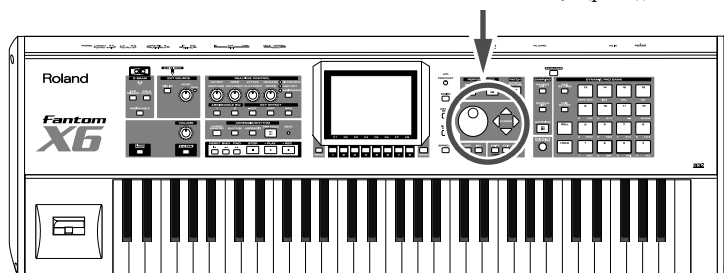
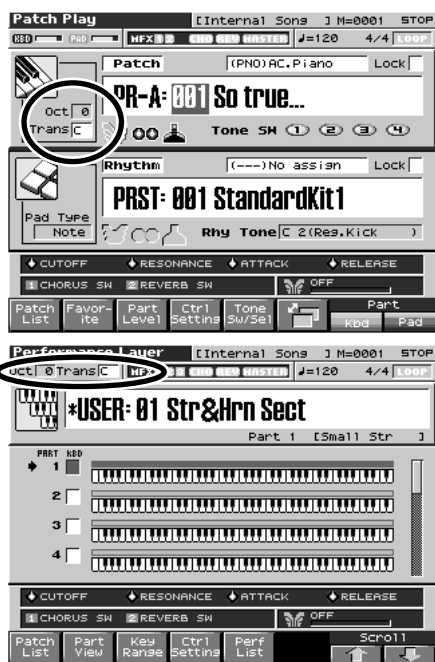

The way in which the sound changes will depend on the settings. For details on settings for parameters controlled by the pedal, refer to "Making Control Pedal Settings" ("Making Control Pedal Settings" (p. 126)).



Use only the specified expression pedal or pedal switch (EV-5, DP-2; sold separately). By connecting any other expression pedals, you risk causing malfunction and/or damage to the unit.



For details, refer to "Transposing the Keyboard in Octave Units (Octave Shift)" ("Transposing the Keyboard in Octave Units (Octave Shift)" (p. 45)).

Overview of the Fantom-X

How the Fantom-X Is Organized

Basic Structure

Broadly speaking, the Fantom-X consists of a controller section, a sound generator section, and a sequencer section. These sections are internally connected via MIDI.

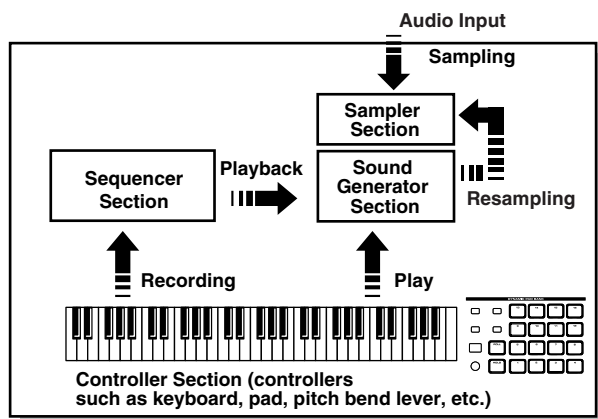

Controller Section

This section consists of the keyboard, pad, pitch bend/modulation lever, panel knobs and buttons, and D Beam controller. It also includes any pedals that may be connected to the rear panel. The performance information generated when you do things such as press/release a key or pad, or depress the hold pedal is converted into MIDI messages and sent to the sound generator section, sequencer section, and/or an external MIDI device.

Sound Generator Section

The sound generator section produces the sound. It receives MIDI messages from the keyboard controller section and sequencer section and/or from an external MIDI device, generates musical sound according to the MIDI messages that were received, and outputs the sound from the output jacks or headphone jack.

Sequencer Section

This section records operations of the keyboard controller section as MIDI messages, and transmits the recorded MIDI messages to the sound generator section. MIDI messages recorded on the sequencer can also be transmitted from the MIDI OUT connector to allow the Fantom-X to also control external MIDI devices.

The Sampler section

A sampler is a device that captures sounds from a CD player or mic connected to the audio input or the digital input (or sounds from a wave file) as "samples."

Samples you record can be used in the same way as the waveforms that are built into the internal sound generator. (p. 141)

The Fantom-X can load WAV or AIFF format wave files as samples via a USB connection. Loaded sample can be used in patches or rhythm sets.

Classification of Fantom-X Sound Types

When using the Fantom-X, you will notice that a variety of different categories come into play when working with sounds. What follows is a simple explanation of each sound category.

Tones

On the Fantom-X, the tones are the smallest unit of sound. However, it is not possible to play a tone by itself. The patch is the unit of sound which can be played, and the tones are the basic building blocks which make up the patch.

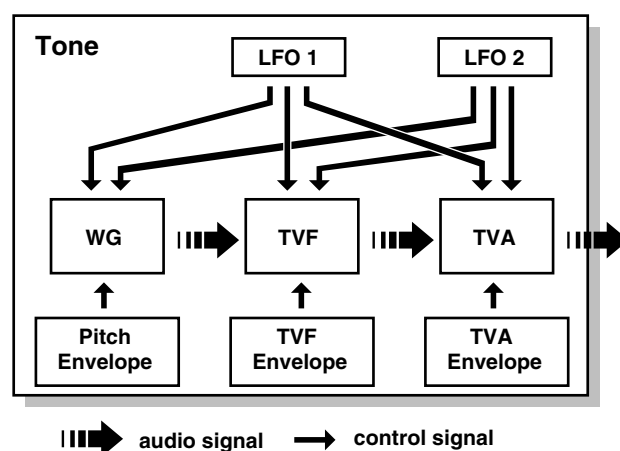

Tones consist of the following five components.

WG (Wave Generator)

Specifies the PCM waveform (wave) that is the basis of the sound, and determines how the pitch of the sound will change.

The Fantom-X has 1,480 different waveforms. All patches built into the Fantom-X consist of combinations of tones which are created based on these waveforms.

NOTE

There are four wave generators for each rhythm tone (percussion instrument sounds).

TVF (Time Variant Filter)

Specifies how the frequency components of the sound will change.

TVA (Time Variant Amplifier)

Specifies the volume changes and the sound's position in a stereo soundfield.

Envelope

You use Envelope to initiate changes to occur to a sound over time. There are separate envelopes for Pitch, TVF (filter), and TVA (volume). For example if you wish to modify the way in which the sound attacks or decays over time, you would adjust the TVA envelope.

LFO (Low Frequency Oscillator)

Use the LFO to create cyclic changes (modulation) in a sound. The Fantom-X has two LFOs. You can use the LFO to apply an effect to either the WG (pitch), the TVF (filter), or the TVA (volume). When an LFO is applied to the WG pitch, a vibrato effect is produced. When an LFO is applied to the TVF cutoff frequency, a wah effect is produced. When an LFO is applied to the TVA volume, a tremolo effect is produced.

NOTE

LFO is not included in the rhythm tones (percussion instrument sounds).

Patches

Patches are the basic sound configurations that you play during a performance. Each patch can be configured by combining up to four tones. How the four tones are combined is determined by the Structure Type parameter (p. 63).

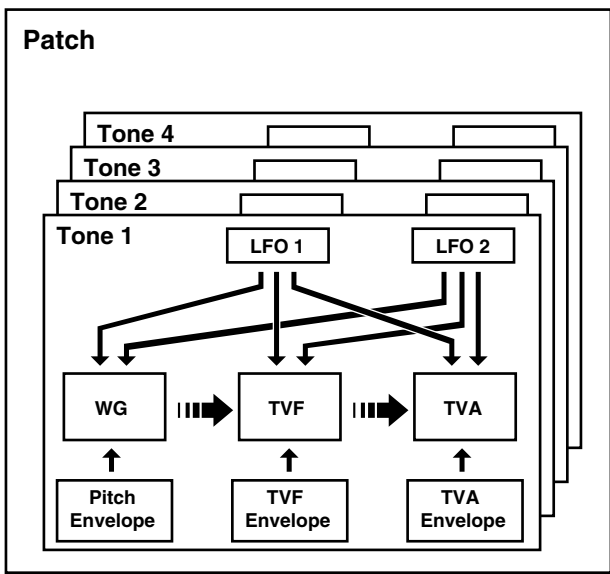

Rhythm Sets

Rhythm sets are groups of a number of different percussion instrument sounds. Since percussion instruments generally do not play melodies, there is no need for a percussion instrument sound to be able to play a scale on the keyboard. It is, however, more important that as many percussion instruments as possible be available to you at the same time. Therefore, each key (note number) of a rhythm set will produce a different percussion instrument.

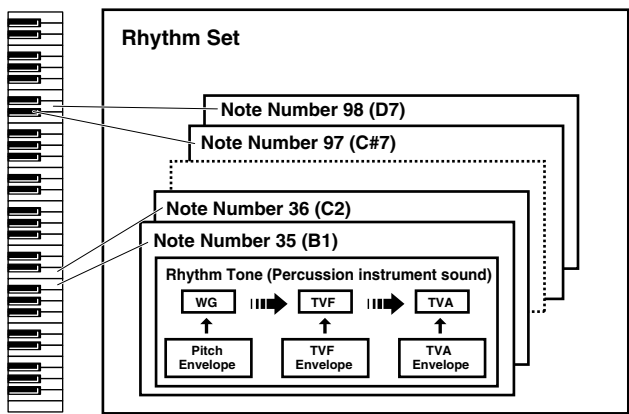

Each percussion instrument consists of the following four elements. (For details, refer to the explanations for "Tones.")

WG (Wave Generator): 1-4

TVF (Time Variant Filter)

TVA (Time Variant Amplifier)

Envelope

Performances

A performance has a patch or rhythm set assigned to each of the 16 parts, and can simultaneously handle 16 sounds.

The Fantom-X has two screens: a Layer screen and a Mixer screen (p. 100, p. 103).

Use the Layer screen if you want to play two or more patches together (Layer) or play different patches in separate areas of the keyboard (Split).

Use the Mixer screen if you want to "mix" by individually adjusting the pan and level settings for each of the sixteen parts.

Because the Fantom sound generator can control multiple sounds (instruments) it is called a Multi-timbral sound generator.

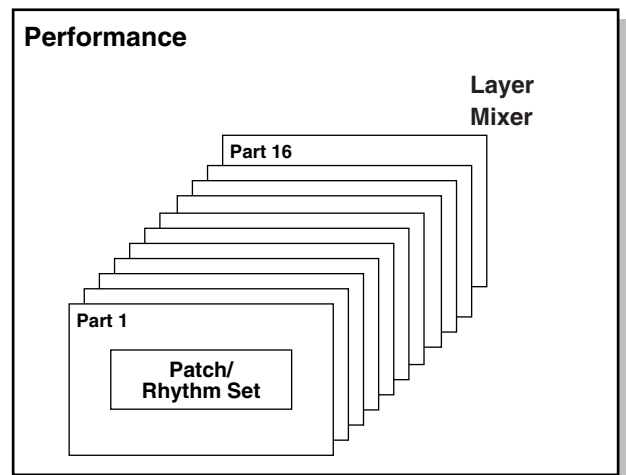

Part

On the Fantom-X, a "part" is something to which you assign a patch or rhythm set. Patch mode has two parts, the Pad part and the Keyboard part, and you can assign a patch or rhythm set to each of these parts. In Performance mode, each performance has sixteen parts, and you can assign a patch or rhythm set to each part.

Overview of the Fantom-X

About Simultaneous Polyphony

The Fantom-X can play a maximum of 128 sounds simultaneously. The following paragraphs discuss what this means, and what will happen when more than 128 simultaneous voices are requested from the Fantom-X.

Calculating the Number of Voices Being Used

The Fantom-X is able to play up to 128 notes simultaneously. The polyphony, or the number of voices (sounds) does not refer only to the number of patches actually being played, but changes according to the number of tones used in the patches, and the number of waves used in the tones. The following method is used to calculate the number of sounds used for one patch being played.

(Number of patches being played) x (Number of tones used by patches being played) x (Number of waves used in the tones)

For example, a patch that combines four tones, each of which use two waves, will use eight notes of polyphony at once. Also, when playing in Performance mode, the number of sounds for each part is counted to obtain the total number of sounds for all parts.

How a Patch Sounds

When the Fantom-X is requested to play more than 128 voices simultaneously, currently sounding notes will be turned off to make room for newly requested notes. The note with the lowest priority will be turned off first. The order of priority is determined by the Patch Priority setting (p. 61).

Patch Priority can be set either to "LAST" or "LOUDEST." When "LAST" is selected, a newly requested note that exceeds the 128 voice limit will cause the first-played of the currently sounding notes to be turned off. When "LOUDEST" is selected, the quietest of the currently sounding notes will be turned off. Usually, "LAST" is selected.

Note Priority in Performance Mode

Since Performance mode is usually used to play an ensemble consisting of several patches, it is important to decide which parts take priority. Priority is specified by the Voice Reserve settings (p. 111). When a note within a patch needs to be turned off to make room for a new note, the Patch Priority setting of the patch will apply (p. 61).

Voice Reserve

The Fantom-X has a Voice Reserve function that lets you reserve a minimum number of notes that will always be available for each part. For example if Voice Reserve is set to "10" for part 16, part 16 will always have 10 notes of sound-producing capacity available to it even if a total of more than 128 notes (total for all parts) are being requested. When you make Voice Reserve settings, you need to take into account the number of notes you want to play on each part as well as the number of tones used by the selected patch (p. 111).

MEMO

It is not possible to make Voice Reserve settings that would cause the total of all parts to be greater than 64 voices.

About Memory

Patch and performance settings are stored in what is referred to as memory. There are three kind of memory: temporary, rewritable, and non-rewritable.

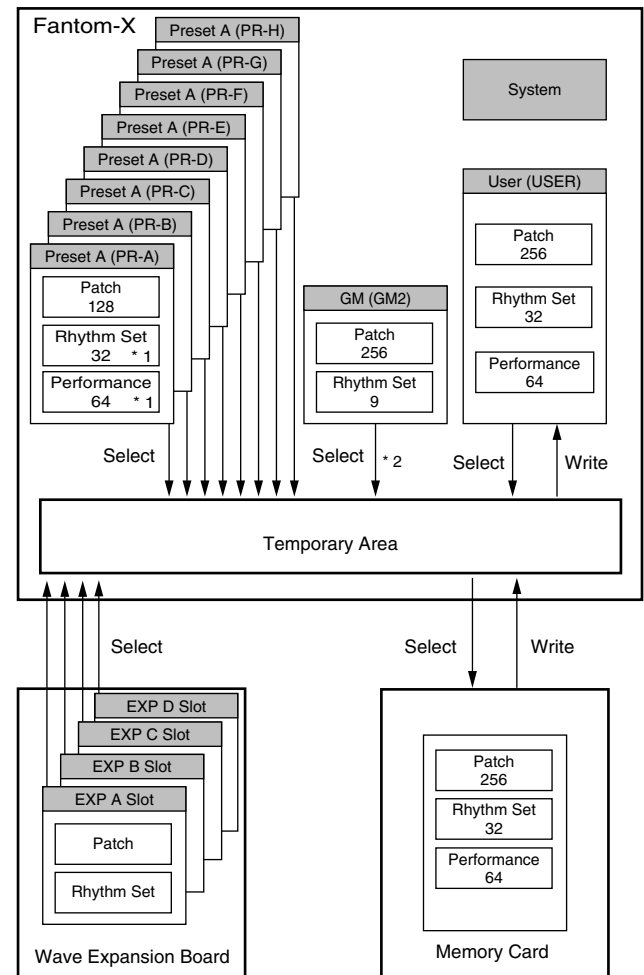

* 1 Only in PR-A (PRST)

* 2 The selected Patches/Rhythm Sets cannot be changed.

Temporary Memory

Temporary Area

This is the area that holds the data for the patch or performance that you've selected using the panel buttons.

When you play the keyboard or play back a sequence, sound is produced based on data in the temporary area. When you edit a patch or performance, you do not directly modify the data in memory; rather, you call up the data into the temporary area, and edit it there.

Settings in the temporary area are temporary, and will be lost when the power is turned off or when you select another patch/performance. To keep the settings you have modified, you must write them into rewritable memory.

Rewritable Memory

System Memory

System memory stores system parameter settings that determine how the Fantom-X functions.

User Memory

User memory is the internal memory area that holds patches, performances, samples, and performance data.

Memory Card

You can use a memory card to store patches, performances, samples, and performance data just as you can in User memory.

Non-Rewritable Memory

Preset Memory

Data in Preset memory cannot be rewritten. However, you can call up settings from preset memory into the temporary area, modify them and then store the modified data in rewritable memory (except GM2).

Wave Expansion Boards (SRX Series; sold separately)

The Fantom-X can be equipped with up to four Wave Expansion Boards (SRX series; sold separately). Wave Expansion Boards contain Wave data, as well as patches and rhythm sets that use this Wave data, which can be called directly into the temporary area and played.

About the Onboard Effects

Effect Types

The Fantom-X has built-in effect units, and you can independently edit each unit's settings.

Multi-Effects

The multi-effects are multi-purpose effects that completely change the sound type by changing the sound itself. Contained are 78 different effects types; select and use the type that suits your aims. In addition to effects types composed of simple effects such as Distortion, Flanger, and other such effects, you can also set up a wide variety of other effects, even connecting effects in series or in parallel. Furthermore, while chorus and reverb can be found among the multi-effects types, the following chorus and reverb are handled with a different system. In Performance mode, three types of multi-effect can be used simultaneously; these are referred to as MFX1, MFX2, and MFX3. In Patch mode, the Keyboard part can use MFX1 and the Pad part can use MFX2.

Chorus

Chorus adds depth and spaciousness to the sound. You can select whether to use this as a chorus effect or a delay effect.

Reverb

Reverb adds the reverberation characteristics of halls or auditoriums. Five different types are offered, so you can select and use the type that suits your purpose.

Mastering Effect

This is a stereo compressor (limiter) that is applied to the final output of the Fantom-X. It has independent high, mid, and low ranges. Independently for the high-frequency, mid-frequency, and low-frequency regions, this compresses any sounds that exceed the specified level, making the volume more consistent.

Overview of the Fantom-X

How Effects Units Work in Different Modes

In Patch Mode

Multi-effects can be used individually by each patch and rhythm set. Chorus and reverb are each shared by patches and rhythm sets; the same effect applies to each tone. Adjusting the signal level to be sent to each effects unit (Send Level) provides control over the effect intensity that's applied to each tone.

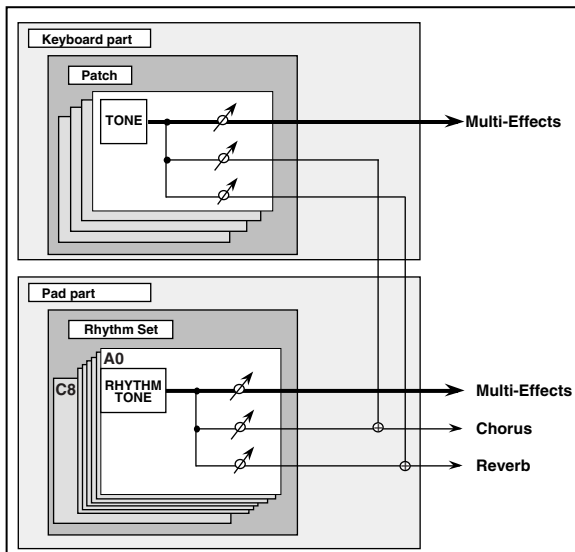

* To each part you can assign either a Patch or a Rhythm Set.

In the Performance Mode

The multi-effects, chorus and reverb effects can be set individually for each performance. The intensity of each effect will be set for each part. When you apply effects in Performance mode, the effect settings of the patch or rhythm set assigned to each part will be ignored, and the effect settings of the performance will be used. Thus, the effects for the same patch or rhythm set may differ when played in Patch mode and in Performance mode. However, depending on the settings, you can have effect settings for a patch or rhythm set assigned to a part applied to the entire performance. In addition, when using the multi-effects settings of a performance, you can use three different multi-effects simultaneously, depending on the effect type.

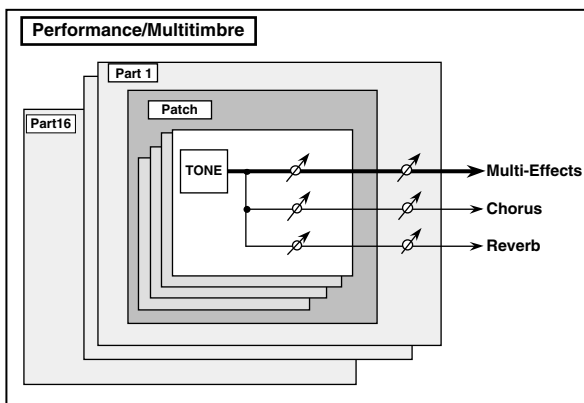

About the Sequencer

A sequencer records keyboard performance and controller movements as MIDI messages (sequencer data). As the data plays back, the recorded MIDI messages are sent to a sound generator which will produce the required sounds. The sequencer actually plays instruments instead of the musician, and since it can record a musical performance, it is a tape recorder as well.

But in reality a sequencer doesn't record sound, but actually the steps that cause the sound generator to produce sound, so it offers several advantages. Sound quality is always excellent, the equivalent of first-generation tape, no matter how many times the data plays back; tempo changes have no effect on pitch; detailed editing is possible, etc.

What Is a Song?

For the Fantom-X, musical performance data for one song or composition is referred to as a song. A song combines sequencer data recorded on Phrase tracks 1-16, a Tempo track, a Beat track and a Pattern, as discussed below.

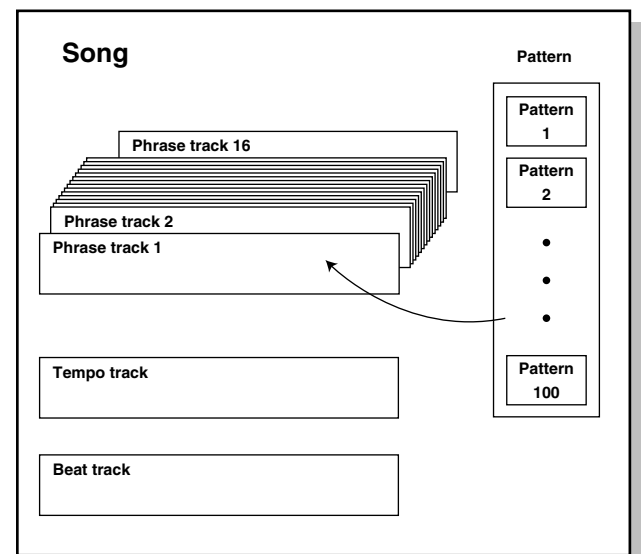

What Is a Track?

Each section of a song which stores musical performance data is called a track.

Phrase Tracks 1-16

Phrase tracks record the musical performance. Each Phrase track records musical performance data for 16 MIDI channels. Totally, up to 16 tracks x 16 MIDI channels of data can be recorded. It's helpful if you've made decision prior to recording such as recording melody on Phrase track 1, bass on Phrase track 2, drums on Phrase track 10, and accompaniment on the remaining Phrase tracks.

Tempo Track

The Tempo track records tempo changes of a song over time. It can be used for tempo changes during a song. If a song has the same tempo from beginning to end, the Tempo track can be ignored.

When a song is first recorded on the Fantom-X, a tempo setting at the time of recording will be stored at the beginning of the Tempo track. Therefore when song playback starts from the beginning, the song will always play back at this initial tempo.

Thus playback tempo is determined by the Tempo track setting. If you modify the tempo during playback, the overall tempo of the song will be controlled by the setting you make.

Beat Track

The Beat track records the time signature of each measure of a song. Set the Beat track when recording a new song, or when you want to change time signature during a song.

Pattern

Patterns are a place to store performance data separately from phrase tracks. You can create up to one hundred patterns; as with a phrase track, each pattern can contain up to sixteen MIDI channels of data.

Patterns can be assigned to phrase tracks. This means that if your song uses repeating phrases such as drum or bass riffs, you can record each phrase as a pattern, and then use the Step Recording window to assign the patterns at the appropriate locations (p. 176). In this case, the phrase track only contains "pattern call numbers" which specify which pattern is to be played. This is convenient, and also lets you conserve memory.

The RPS function (p. 203) for immediate playback also applies to Patterns. Patterns are therefore convenient for live performance, if you've recorded necessary sequencer data as Patterns and take them to the gig.

Patterns also make fine scratch-pads for musical ideas.

Songs and the Sound Generator Mode

The Fantom-X's sequencer can be used at any time, regardless of the mode of the sound generator (Patch/Performance).

In Performance mode you can use up to sixteen sounds, with each part playing a different sound. This means that Performance mode is ideal for recording or playing an ensemble that uses multiple instruments, such as drums, bass, and piano.

In Patch mode you can play using the sounds that are assigned to the Keyboard part and the Pad part.

Positions for Storing a Song

Temporary Area

The sequencer has an area called Temporary Area that can temporarily store one song. So we call this temporary song.

To play back a song saved to a disk with the Fantom-X, it doesn't have to be loaded into Temporary Area. Only when you're going to record a song or edit a song saved to disk, do you have to load it into Temporary Area. Since only one song can be worked on during recording or editing, all the Temporary Area has to do is store one song (about 120,000 notes).

The song in Temporary Area is volatile and will be lost when the power is turned off. To keep a song, you must save it to user memory or memory card.

Memory Card/User Memory

When keeping a recorded or edited song in Temporary Area, save it to user memory or memory card as a song file. Up to 256 songs can be saved to a card and user memory.

If you want to keep the song in Temporary Area that you recorded or edited, you must save it as a song file onto a memory card or into user memory. Either method lets you save up to 256 songs.

A card and user memory can contain two file types. The three-letter symbol shown in parentheses () is a file name extension that distinguishes the different file types.

Song File (.SVQ)

This file is a song created on the Fantom-X. It is called an MRC Pro song.

Standard MIDI File (.MID)

Standard MIDI File is a standard file format that allows sequencer data to be exchanged between most musical applications. Fantom-X files can be saved as Standard MIDI Files. This also allows you to play back commercially available music data (GM scores) that is compatible with the GM/GM2 system.

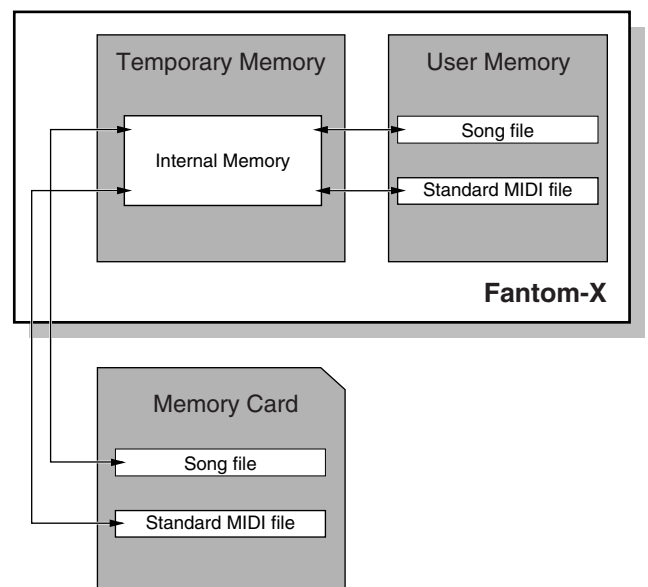

Overview of the Fantom-X

About the Sampling Section

The Sampling section samples (records) external sounds from an audio device or mic as digital data. Sampled sounds can be played as a patch or rhythm set. You can also import WAV/AIFF format files and use them in the same way.

Samples

A **sample** contains the waveform data sampled by the Fantom-X. In addition to the actual waveform data itself, a sample also contains parameters such as start point, loop start, and loop end. The Fantom-X can hold 9,000 samples.

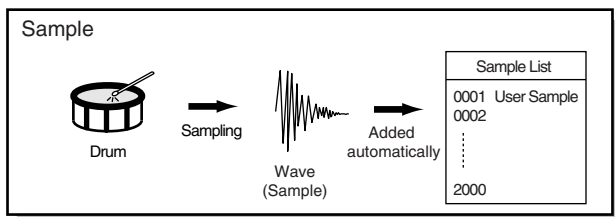

Multisamples

Two or more samples assigned to the keyboard are collectively called a **multisample**. A multisample is divided into 128 "splits." Each split contains the number of a sample in the sample list—it does not contain the actual sample data itself.

The Fantom-X has 128 internal samples (preset samples), and in addition can store up to 128 user samples in a separately sold memory card.

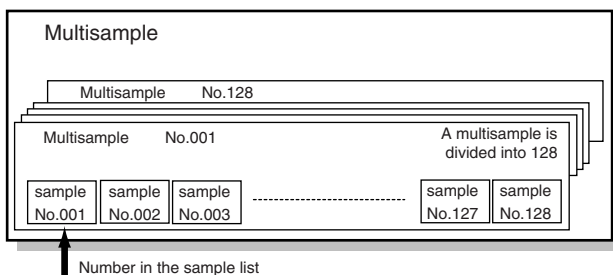

Where Samples are Stored

Samples that you record or import are stored in sample memory. This sample memory is temporary, and its data will be lost when you turn off the power. If you want to keep these samples, you must save them to user memory or a memory card.

* You cannot save data to the preset memory.

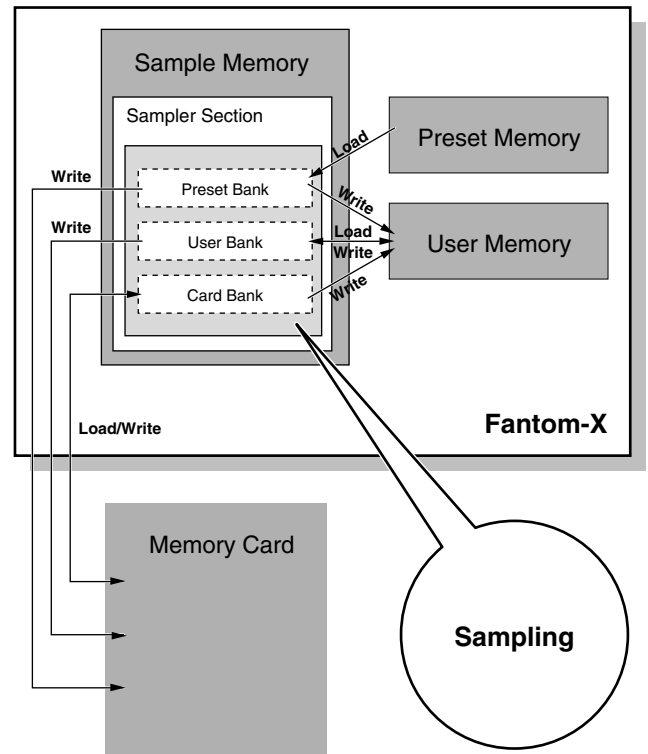

Basic Operation of the Fantom-X

Switching the Sound Generator Mode

The Fantom-X has two sound generating modes: Patch mode, Performance mode. You can select the sound generating mode (state) that is most appropriate for how you are playing the Fantom-X. Use the following procedure to switch between these modes.

Patch mode

In this mode you can use the keyboard and pads to play individual sounds (patches/rhythm sets).

The keyboard and pads each have their own sound generator and part, and are connected on a single MIDI channel.

To select Patch mode

1. Press [PATCH/RHYTHM].



Performance Mode

This mode allows you to combine multiple sounds (patches or rhythm sets).

LAYER/SPLIT display

Use this screen when you want to play two or more sounds (patches/rhythm sets) together.

You can play patches together (Layer) or divide the keyboard into two regions and play different patches in each region (Split).

MIXER display

Use this screen when you want to mix the sounds by adjusting the level and pan for each of the 16 parts.

MEMO

The Layer screen and Mixer screen provide different views of the same performance. For example, you'll want to use the Layer/Split screen when you're setting up a keyboard split, or use the Mixer screen when you're adjusting the effect settings or volume balance of the patches for each part.

To select the Layer screen

1. Press [LAYER/SPLIT].

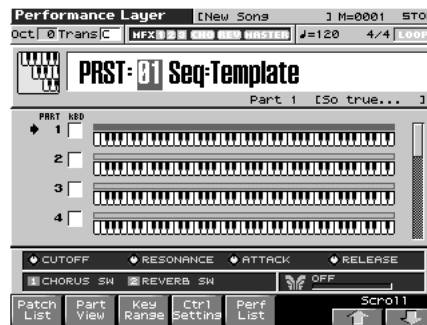

To select the Mixer screen

1. Press [MIXER].

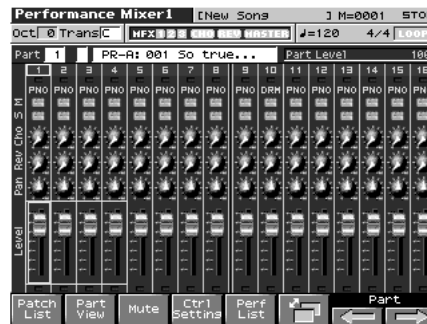

Overview of the Fantom-X

About the Function Buttons

The eight [F1]–[F8] buttons (function buttons) located below the display execute various functions, and their operation will differ depending on the screen. Functions will be listed in the bottom of the screen.

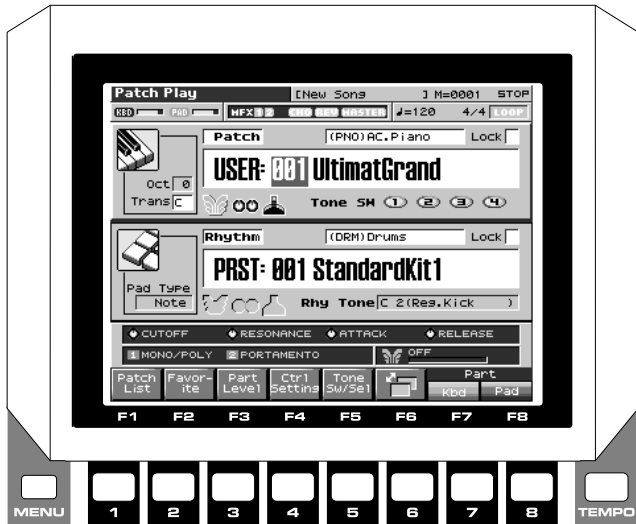

Window

The somewhat smaller screens that appear temporarily on top of the normal screens are called windows. Various types of windows appears according to the situation. Some display lists, others allow you to make settings, and still others ask you to confirm an operation.



Press [EXIT] to close the window. Some windows will close automatically when an operation is performed.

Moving the Cursor

A single screen or window displays multiple parameters or items for selection. To edit the setting of a parameter, move the cursor to the value of that parameter. To select an item, move the cursor to that item. When selected with the cursor, a parameter value or other selection is highlighted.



Move the cursor with the ▲, ▼, ◀, and ▶ (cursor buttons).

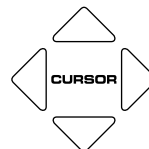

- ▲ : moves the cursor up.
- ▼ : moves the cursor down.
- ◀ : moves the cursor to the left.
- ▶ : moves the cursor to the right.

TIP

If you hold down one cursor button while you also press the cursor button for the opposite direction, the cursor will move more rapidly in the direction of the first-pressed cursor button.

TIP

When the cursor is displayed, pressing [ENTER] will sometimes display a list of the available choices for that parameter. This is convenient when you want to see what your choices are. When the list is displayed, you can also use the pads to input your choice. (p. 35)

Modifying a Value

To modify the value, use the VALUE dial or the [INC]/[DEC] buttons.

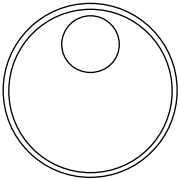

TIP

In each screen of the Fantom-X, you can use the cursor to move the area displayed as highlighted, and modify its value.

NOTE

Each parameter has its own range of possible values, so you cannot set any value smaller than the minimum value or greater than the maximum value.

VALUE Dial

Rotating the VALUE dial clockwise increases the value, counterclockwise decreases the value. Holding down [SHIFT] as you move the VALUE dial increases value increments so you can make large value changes faster.

When the cursor is located at a parameter value, press [ENTER] to display a window where you can set the value. Use ▲ ▼ to select a value, and then press [ENTER] to finalize the setting.

[INC] and [DEC]

Pressing [INC] increases the value, and [DEC] decreases it. Keep the button pressed for continuous adjustment. For faster value increases, keep [INC] pressed down and press [DEC]. For decreasing value faster, keep [DEC] pressed down and press [INC].

If you press [INC] or [DEC] while holding down [SHIFT], the value increments will get bigger.

Using the pads

In some cases when the cursor is located at an input location, you can press [ENTER] to see a list of parameter values. For some of these lists, the screen will show an icon like the following, which means you can use the pads to input or specify the value.

When inputting a numerical value

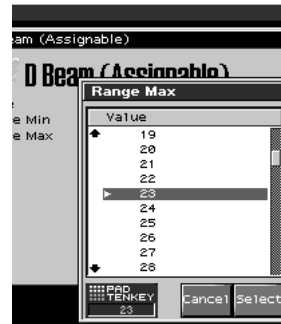

PAD 1-9: Input numerals 1-9

PAD 10: Input the numeral 0

BS: Cancels the numeral you input

DEL: Cancels the lowest place of the number you input. If you've input "15," pressing DEL will change the value to "1."

When inputting directly

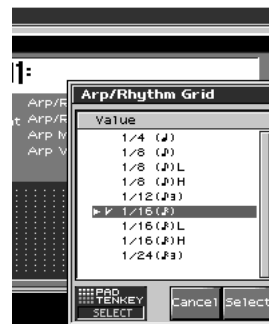

Pressing a pad will directly input the corresponding value. From the top, the items in the list correspond to pads 1-16.

Overview of the Fantom-X

Assigning a Name

On the Fantom-X, you can assign names to each patch, rhythm set, performance, Song, Sample, and Pattern. The procedure is the same for any type of data.

1. Press [CURSOR] to move the cursor to the location where you wish to input a character.



2. Turn the VALUE dial, or press [INC]/[DEC] to specify the character.

- [F1 (Change Type)]: Selects the type of character. Each time you press this, you will alternately select the first character of a character set: uppercase (A), lowercase (a), or numerals and symbols (0).
- [F2 (Delete)]: Deletes the character at the cursor location, and moves the subsequent characters one space forward.
- [F3 (Insert)]: Inserts a space at the cursor location.
- ◀ or ▶: Move the cursor.
- ▲, ▼: Switch between uppercase and lowercase letters.

* If you decide to discard your input, press [F7 (Cancel)].

Available characters/symbols are:

space, A-Z, a-z, 0-9, ! " # \$ % & ' () * + , - . / : ; < = > ? @ [\] ^ _ ` { | }

TIP

From a naming screen you can press [MENU] and select "Undo" to return the name to what it was before you changed it. From [MENU] you can select "To Upper" or press ▲ to change the character at the cursor to uppercase. From [MENU] you can select "To Lower" or press ▼ to change the character at the cursor to lowercase. From [MENU] you can select "Delete All" to clear all the characters you were inputting.

NOTE

Song file names may not contain lowercase characters or certain symbols (" * + , . / : ; < = > ? [\] |).

Using the Pads to Specify Characters

You can use the pads to specify characters.

By pressing a pad one or more times, you can successively select the letters, numerals, and symbols that appear on the pad. For example, if you repeatedly press pad 1, you will cycle through the available choices like this: 1 -> A -> B -> C -> 1 -> A...

- You can switch between uppercase and lowercase letters for the character to be entered by pressing CAPS LOCK.
- Press SPACE to replace the character at the cursor location with a space.
- Press INS to insert a space at the cursor location.
- Press DEL to delete the character at the cursor location.
- Press BS to delete the character to the left of the cursor location.

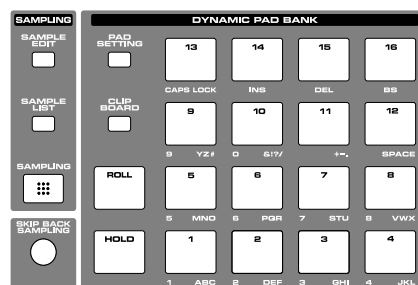

Registering and recalling frequently used screen pages (Bookmark)

This function lets you register frequently used screen pages, and use the pads to access them. For example, if you find yourself frequently moving between the Patch Edit page and the Effect page, this function will help you switch between these two pages more efficiently.

Registering a page

1. Access the page that you want to register.
2. Hold down [CLIP BOARD] and press the pad to which you want to register this page.
For example, if you register the page at pad number 3, the display will indicate "Bookmarked to #3."
3. Press [EXIT].
The settings are stored in the Fantom-X.
** If you do not press [EXIT], these settings will be lost when you turn off the power.*

Recalling a page

1. Press [CLIP BOARD].
The Bookmark screen will appear.
Pads for which a page has been registered will blink.

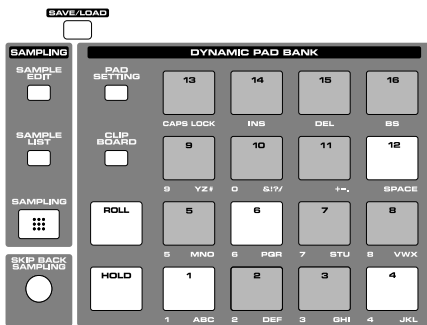

2. Press one of the blink pads; the Bookmarked to that pad will appear.
** To clear a registered page, hold down [CLIPBOARD] in step 1 and press the pad whose registration you want to clear.*

Viewing an explanation of each button (Help)

Here's how you can make the Fantom-X's screen display a brief explanation of each button or what the button does when pressed while holding down the [SHIFT] key.

1. Press [MENU].
2. Use the VALUE dial or [INC][DEC] to select "Help."
3. Press [ENTER].
The "Help" screen will appear.

Viewing the number of voices used by the sound generator (Voice Monitor)

Here's how you can see a graphic indication of the number of voices used by the sound generator.

1. In the Patch mode or Performance mode screen, hold down [SHIFT] and press [F4 (Voice Monitor)].
2. Press [F8 (Exit)] to return to the previous screen.

Playing in Patch Mode

In Patch mode, the keyboard and the pads are each used to play a single sound (patch/rhythm set).

The keyboard controller section and the pad controller section each have their own sound generator part, and each are connected by their own MIDI channel. This means you can play separate sounds on the keyboard and the pads.

About the Patch Play Screen

Displaying Patch Play Screen

To access the Patch Play screen, use the following procedure.

1. Press **[PATCH/RHYTHM]**.
You will enter Patch mode, and the Patch Play screen appears. The Fantom-X has two parts; a Keyboard part and a Pad part.
2. Press **[F7 (Part Kbd)]** to select the Keyboard part.

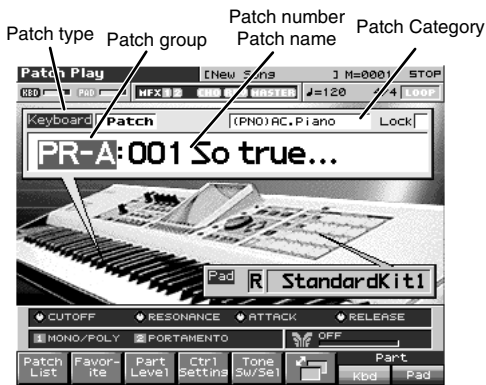

3. Press **[F8 (Part Pad)]** to select the Pad part.



4. Press **[F6]** to switch the Patch Play screen.

This screen simultaneously displays the settings of the Keyboard part and the Pad part.

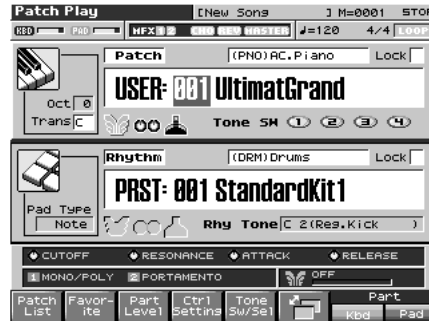

Press **[F3 (Part Level)]** to adjust the volume of the keyboard part and pad part.

Pressing **[F8 (Part Level)]** will open a window where you can adjust the volume of the keyboard part and pad part.

Press **[F6]** (keyboard part) or **[F7]** (pad part) to select the part, and turn the VALUE dial or use **[INC]**/**[DEC]** to adjust the volume.

Press **[F8 (Close)]** to close the window.



Functions in the Patch Play screen

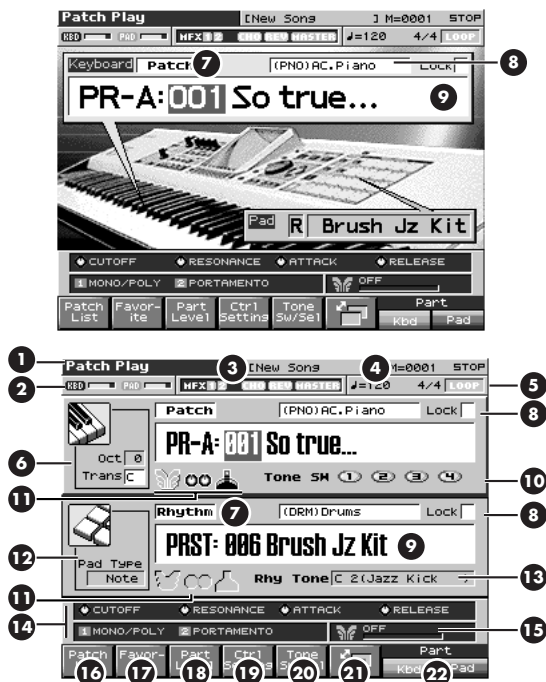

- 1 Indicates the current sound generating mode.
- 2 Indicates the volume of the Keyboard part and Pad part.
- 3 Indicates multi-effects (MFX1, 2), chorus (CHO), reverb (REV), and mastering (MASTER) on and off.
- 4 Indicates the name of the currently selected song, the measure location
- 5 Indicates the time signature, and the tempo. Indicates the Loop Play on/off (LOOP).
- 6 Sets the Transpose (Trans). And indicates the Octave Shift (Oct).
- 7 Patch/rhythm set select switch
Determines whether you will be selecting patches or rhythm sets.
- 8 Indicates/selects the patch category.
Selects whether the patch category will be locked.
- 9 Indicates/selects the group, number, and name of the selected patch.
- 10 Indicates the tone On/Off status.
- 11 Indicates whether the controller settings will apply to the keyboard or the pads.
- 12 Indicates the state of the pad settings.
- 13 Indicates the rhythm tone.
- 14 Indicates the functions that are assigned to each realtime controller knob (●) and assignable switch (■).
- 15 This indicates the function that is assigned to the D Beam controller, and the response status of the D Beam controller.
- 16 Displays the Patch List screen.
- 17 Displays the Favorite screen.
- 18 Adjusts the volume of the keyboard part and pad part.
- 19 Displays the Control Setting screen.
- 20 Displays the Tone SW/Select screen.
- 21 Switches the Patch Play screen.
- 22 Switches the keyboard part and pad part.

Selecting a Patch

The Fantom-X has eight patch groups, including the User group and Preset groups A–H and GM, with each group storing 128 patches (256 in GM, USER). What's more, you can further expand your options by installing up to four optional Wave Expansion Boards (SRX series; sold separately), enabling you to select from a huge assortment of available patches.

USER

This is the group inside the Fantom-X which can be rewritten. patches you yourself create can be stored in this group. The Fantom-X includes 256 preset patches.

PR-A–H (Preset A–H)

This is the group inside the Fantom-X which cannot be rewritten. However you may modify the settings of the currently selected patch, and then store the modified patch in User memory. Groups A–H already contain 128 prepared patches each, for a total of 1024 patches.

CARD (Memory Card)

This group lets you use patches stored on a memory card inserted in the rear panel card slot. Since the data in this group can be rewritten, you can use this group to store patches that you create.

GM (GM2)

This is an internal group of patches compatible with General MIDI 2, a system of MIDI function specifications designed to transcend differences between makers and types of devices; these patches cannot be overwritten. Furthermore, settings of currently selected patches from this group cannot be changed. The Fantom-X includes 256 preset patches.

XP-A–D (Wave Expansion Boards installed in EXP-A–D Slots)

These are groups used when using patches from Wave Expansion Boards installed in the EXP A–D slots, and cannot be rewritten. However you may modify the settings of the currently selected patch, and then store the modified patch in User memory and Memory card. The number of onboard patches depends on the specific Wave Expansion Boards installed.

NOTE

XP-A–D patches can be selected only if a Wave Expansion Board SRX series (SRX series; sold separately) is installed in the corresponding slot.

Playing in Patch Mode

1. Press [PATCH/RHYTHM] to access the Patch Play screen.

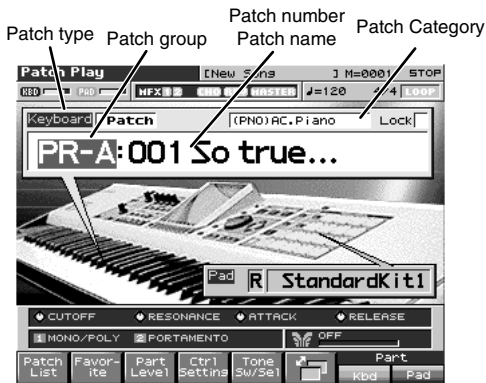

2. Press [F7 (Part Kbd)] or [F8 (Part Pad)] to move the cursor to the pad part or the keyboard part.

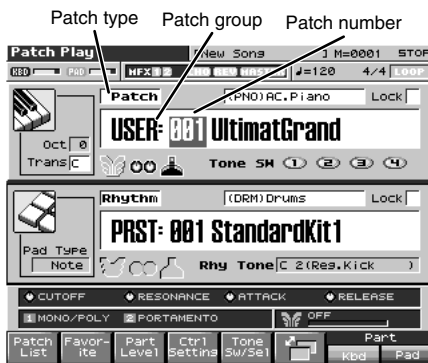

3. If you selected a patch group, turn the VALUE dial or use [INC]/[DEC] to choose the patch group.
USER: User
PR-A-H: Preset A-H
CARD: Memory Card
GM: GM (GM2)
XP-A-D: Wave Expansion Boards installed in EXP-A-D Slots
** Make sure that the patch type select switch is set to "Patch." If this is set to "Rhythm," use [CURSOR] to move the cursor to the switch, and turn the VALUE dial or press [DEC] to select "Patch."*
4. Press [CURSOR] to move the cursor to the patch group.
5. Turn the VALUE dial, or press [INC]/[DEC] to select a patch group.
6. If you selected a patch for the pad part, play the pads to hear the sound. If you selected a patch for the keyboard part, play the keyboard to hear the sound.

Selecting Patches by Category (Patch Finder)

The Fantom-X provides a "Patch Search function" (Patch Finder) which allows you to specify a type (category) of patch so that you can quickly find the desired patch. There are a total of 38 categories.

1. Press [PATCH/RHYTHM] to access the Patch Play screen.

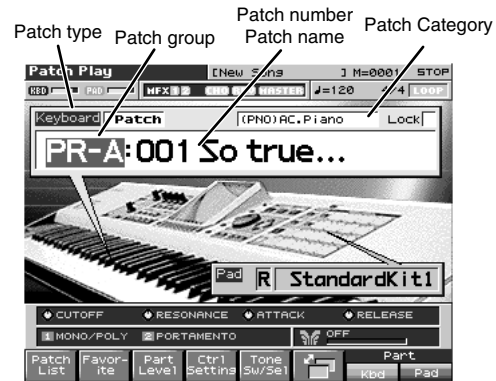

2. Make sure that the patch type is set to "PATCH." If this is set to "Rhythm," use [CURSOR] to move the cursor to the switch, and turn the VALUE dial or press [DEC] to select "Patch."
3. Use [CURSOR] to move the cursor to the "Patch Category," and turn the VALUE dial, or press [INC]/[DEC] to select the desired category.
4. Press ► to move the cursor to "Lock," and turn the VALUE dial or press [INC] to add a check mark (✓).
5. Use [CURSOR] to move the cursor to the patch group or patch number, and turn the VALUE dial or use [INC]/[DEC] to select the patch.
 When the cursor is located at the Patch group, you can select the group. When the cursor is located at the Patch number, you can specify the number.

The following categories can be selected.

Category		Contents
---	No Assign	No assign
PNO	AC.Piano	Acoustic Piano
EP	EL.Piano	Electric Piano
KEY	Keyboards	Other Keyboards (Clav, Harpsichord etc.)
BEL	Bell	Bell, Bell Pad
MLT	Mallet	Mallet
ORG	Organ	Electric and Church Organ
ACD	Accordion	Accordion
HRM	Harmonica	Harmonica, Blues Harp
AGT	AC.Guitar	Acoustic Guitar
EGT	EL.Guitar	Electric Guitar
DGT	DIST.Guitar	Distortion Guitar
BS	Bass	Acoustic & Electric Bass
SBS	Synth Bass	Synth Bass
STR	Strings	Strings
ORC	Orchestra	Orchestra Ensemble
HIT	Hit&Stab	Orchestra Hit, Hit
WND	Wind	Winds (Oboe, Clarinet etc.)
FLT	Flute	Flute, Piccolo
BRS	AC.Brass	Acoustic Brass
SBR	Synth Brass	Synth Brass
SAX	Sax	Sax
HLD	Hard Lead	Hard Synth Lead
SLD	Soft Lead	Soft Synth Lead
TEK	Techno Synth	Techno Synth
PLS	Pulsating	Pulsating Synth
FX	Synth FX	Synth FX (Noise etc.)
SYN	Other Synth	Poly Synth
BPD	Bright Pad	Bright Pad Synth
SPD	Soft Pad	Soft Pad Synth
VOX	Vox	Vox, Choir
PLK	Plucked	Plucked (Harp etc.)
ETH	Ethnic	Other Ethnic
FRT	Fretted	Fretted Inst (Mandolin etc.)
PRC	Percussion	Percussion
SFX	Sound FX	Sound FX
BTS	Beat&Groove	Beat and Groove
DRM	Drums	Drum Set
CMB	Combination	Other patches which use Split and Layer

Selecting Patches from the List

You can display a list of patches and select a patch from that list.

1. Press [PATCH/RHYTHM] to access the Patch Play screen.
2. Press [F1 (Patch List)].
The Patch List screen will appear.



Press [F4 (Patch Categ)] to see a list sorted by category, or press [F5 (Patch)] or [F6 (Rhythm)] to see the patch group list.

3. Use [F1]/[F2] to select a category or group.
4. Turn the VALUE dial or use [DEC]/[INC] or ▲ / ▼ to select a patch.



You can press [F7 (Preview)] to audition the patch using an appropriate phrase that is preset for each category (Phrase Preview).

5. Press [F8 (Select)] to confirm your patch selection.

Playing in Patch Mode

Auditioning Patches (Phrase Preview)

The Fantom-X allows you to preview patches by hearing a phrase appropriate for each type of patch.

1. Press [PATCH/RHYTHM] to access the Patch Play screen.
2. Press [F1 (Patch List)] to access the Patch List screen.



3. Press and hold [F7 (Preview)].
The patch selected in the Patch List screen will be sounded.
4. Release your finger from [F7 (Preview)], and the phrase will stop playing.

cf.

If you wish to change how the phrase is played by Phrase Preview, you can edit the Preview Mode parameter (p. 232).

Creating a list of frequently used Patches and Performances (Live Setting)

You can create a list of frequently used sounds, and recall them instantly. Since you can register Patches, Rhythm Sets, or Performances, any type of sound you need can be recalled instantly regardless of the mode.

Each list (bank) can store a total of sixteen patches, rhythm sets, and performances. You can create twenty of these banks.

For example, you might use bank 1 to list up to sixteen sounds that you use in the first song of your live set.

Recalling sounds

1. Press [MENU] to open the Menu window.
2. Either turn the VALUE dial or press ▲ or ▼ to select “Live Setting Play,” and then press [ENTER].
The Live Setting Play screen appears.



MEMO

You can also hold down [SHIFT] and press [PIANO MODE] to access the Live Setting Play screen.

3. Press ▲ or ▼ to select the bank that you want to recall.
4. Press [F1 (1)]–[F8 (8)] to select the step number that you want to recall.
To select 9–16, hold down [SHIFT] and press [F1 (9)]–[F8 (16)].
The selected sound will be recalled.

TIP

Alternatively, in step 4 of this procedure, you can use [INC]/[DEC] to step through the sounds by moving to the next (or previous) step number.

TIP

In step 4 of this procedure, you can also use ◀ or ▶ to select the step number. In this case, the sound will not change until you press [ENTER].

Registering a sound

1. Access the screen of the patch, rhythm set, or performance that you want to register.
2. Press [MENU] to open the Menu window.
3. Either turn the VALUE dial or press ▲ or ▼ to select “Live Setting Edit,” and then press [ENTER].

The Live Setting Edit screen appears.



MEMO

You can also hold down [SHIFT] and press [ENTER] to access the Live Setting Edit screen.

4. Use ▲ or ▼ ([F1 (↑)] or [F2 (↓)]) to select the bank in which you want to register the sound.
5. Use ◀ or ▶ to select the number (step) in which to register the sound.
You can register the sound in any of the sixteen steps. Register the sounds in an order that's appropriate for your song or live performance.
6. Press [F8 (Regist)] to register the sound.
For example, if you register the sound in Bank 1, step number 02, the display will indicate “Regist to 1-02.”

Removing a registration

1. In the Live Setting Edit screen, use ◀ or ▶ to move the cursor to the step that you want to remove.
2. Press [F7 (Remove)].
For example, if you remove the registration for Bank 1, step number 02, the display will indicate “Remove 1-02,” and that step becomes empty.

Removing all sound registrations from a bank

1. In the Live Setting Edit screen, use [F1 (↑)] or [F2 (↓)] to move the cursor to the bank for which you want to clear the registrations.
2. Hold down [SHIFT] and press [F7 (Bank Remove)].
If you clear the entire contents of Bank 1, the display will indicate “Remove Bank 1,” and that bank is made empty.

Changing the step at which a sound is registered

Here's how to change the step at which a sound is registered.

1. In the Live Setting Edit screen, use ◀ or ▶ to move the cursor to the step at which the sound you want to move is registered.
2. Hold down [SHIFT] and use ◀ or ▶ to move the sound.

Importing a Text File (Import Text)

Here's how you can import a text file you created on your computer, and display it in the Fantom-X's Live Setting screen.

1. Access the Live Setting Edit screen, and press ▲ or ▼ ([F1 (↑)] or [F2 (↓)]) to select the Bank whose text you want to view.
2. Press [F6 (Import Text)].



3. Press [F1 (User)] or [F2 (Card)] to select the area (user memory or card) from which you want to import the text file.
4. Press ▲ or ▼ to select the file you want to import.
5. Press [F8 (Import Text)].
The file you want to import will be displayed.
* To cancel, press [F7 (Cancel)].
6. Press [F8 (Exec)].
The file will be imported.
* To cancel, press [F7 (Cancel)].

MEMO

You can scroll the screen by turning the VALUE dial.

Selecting Favorite Patches (Favorite Patch)

In the patch mode, You can bring together your favorite and most frequently used patches in one place by registering them in the favorite patch. By using this function, you can rapidly select favorite patches from Preset/User/Card area or a Wave Expansion Board.

1. Press [PATCH/RHYTHM] to access the Patch Play screen.
2. Press [F2 (Favorite)].

The Favorite Patch window appears.



3. Press ▲ or ▼ to choose the patch.
4. To change the bank, turn the VALUE dial or use [INC][DEC].
5. After you have changed the bank, press [F1]–[F8] to select a patch.
6. Press [EXIT] to close the Favorite Patch window

Registering a Favorite Patch

You can bring together your favorite and most frequently used patches in one place by registering them in the favorite patch. By using this function you can rapidly select favorite patches from Preset/User/card area or a Wave Expansion Board. You can register a total of 64 sounds (8 sounds x 8 banks) as favorite patches.

cf. ➔

For details on selecting a favorite patch, refer to “Registering a Favorite Patch” (p. 44).

Using [F1]–[F8] to Register

1. Press [PATCH/RHYTHM] to access the Patch Play screen to select the patch that you wish to register (p. 39).

2. Press [F2 (Favorite)].



3. Turn the VALUE dial or press [INC][DEC] to select the Bank.
4. Hold down [SHIFT] and press [F1]–[F8] to execute the registration.
The patch will be registered to the button you pressed.
5. When you have finished registering, press [EXIT].

Using the Favorite List Screen to Register

1. Press [PATCH/RHYTHM] to access the Patch Play screen to select the patch that you wish to register (p. 39).
2. Press [F1 (Patch List)].
3. Press [F3 (Favorite)].
The Favorite List screen appears.



4. Press [F1 (↑)] or [F2 (↓)] to select the Bank.
5. Press ▲ or ▼ to select a favorite number.
6. Press [F6 (Regist)] to execute the registration.
The patch will be registered to the button you pressed.
7. When you have finished registering favorite patches, press [EXIT] to close the Favorite List screen.

TIP

By pressing [F7 (Preview)] you can audition the sound of the registered patch (Phrase Preview).

Canceling a patch registration

By pressing [F5 (Remove)] you can cancel the patch registration that is selected in the Favorite List screen.

Registering Favorite Rhythm Sets

You can bring together your favorite and most frequently used rhythm sets in one place by registering them in the favorite patch. By using this function you can rapidly select favorite rhythm sets from Preset/User/Card area or a Wave Expansion Board. You can register a total of 64 sounds (8 sounds x 8 banks) as favorite patches.

cf.

For details on selecting a favorite patch, refer to “**Selecting Favorite Patches (Favorite Patch)**” (p. 44).

Using [F1]–[F8] to Register

1. Press [PATCH/RHYTHM] to access the Patch Play screen, and select the rhythm set that you wish to register (p. 52).
2. Press [F2 (Favorite)].
3. Turn the VALUE dial or press [INC]/[DEC] to select the Bank.
4. Hold down [SHIFT] and press [F1]–[F8] to execute the registration.
The rhythm set will be registered to the button you pressed.
5. When you have finished registering, press [EXIT].

Using the Favorite List Screen to Register

1. Press [PATCH/RHYTHM] to access the Patch Play screen, and select the rhythm set that you wish to register (p. 52).
2. Press [F1 (Patch List)].
3. Press [F3 (Favorite)].
The Favorite List screen appears.



4. Press [F1 (↑)] or [F2 (↓)] to select the Bank.
5. Press ▲ or ▼ to select favorite number.
6. Press [F6 (Regist)] to execute the registration.

TIP

By pressing [F7 (Preview)] you can audition the sound of the registered rhythm set (Phrase Preview).

7. When you have finished registering favorite patches, press [EXIT] to close the Favorite List screen.

Canceling a patch registration

By pressing [F4 (Remove)] you can cancel the patch registration that is selected in the Favorite List screen.

Transposing the Keyboard in Octave Units (Octave Shift)

The **Octave Shift** function transposes the pitch of the keyboard in 1 octave units (-3+ 3 octaves).

For playing a bass part more easily using your right hand, transpose the keyboard down by 1 or 2 octaves.

* *Octave Shift applies only to the keyboard part.*

1. Press [PATCH/RHYTHM] to access the Patch Play screen.
2. Press **KEYSHIFT [-OCT]** or **[+OCT]** to set the amount of transposition (-3+3).

The button will light if this is set.

* *Each time you press [+OCT], the amount of transposition will change in the order of +1, +2, and +3. Each time you press [-OCT], the amount of transposition will change in the order of -1, -2, and -3. If you press both buttons simultaneously, the amount of movement will be zero.*



NOTE

There is a single Octave Shift setting (Setup parameter) for the entire Fantom-X. The changed setting will be remembered even if you switch patches or performances.

Playing in Patch Mode

Transposing the Keyboard in Semitone Steps (Transpose)

Transpose changes keyboard pitch in units of semitones. This function is useful when you play transposed instruments such as trumpet or clarinet following a printed score.

* *Transpose applies only to the keyboard part.*

1. Press [PATCH/RHYTHM] to access the Patch Play screen.
2. Press [F7 (Part Kbd)] to move the cursor to the keyboard part.
3. Press [F6] to switch the Patch Play screen.
4. Use [CURSOR] to move the cursor to “Trans.”



5. Either turn the VALUE dial or use [INC]/[DEC] to adjust the Transpose setting (G-F#: -5+6 semitones).

NOTE

There is a single Transpose setting (Setup parameter) for the entire Fantom-X. The changed setting will be remembered even if you switch patches or performances.

TIP

If you assign “Transpose Up” “Transpose Down” as a function to be controlled by the realtime assignable switches ([\square^1]/[\square^e]), you can easily change the Transpose by pressing these buttons (p. 125).

Selecting the Tones That Will Sound (Tone On/Off)

Since a patch is a combination of up to four tones, you can switch unwanted (tones out of the four) off and get just the sound of a specific tone.

1. Press [PATCH/RHYTHM] to access the Patch Play screen.
2. Press [F7 (Part Kbd)] or [F8 (Part Pad)] to move the cursor to the pad part or the keyboard part.

3. Press [F5 (Tone Sw/Sel)].



4. Press [F1 (Tone Sw)]/[F4 (Tone Sw)] to turn each tone on/off. The setting will switch on/off each time you press the button.
5. Press [EXIT] to close the window.

TIP

If you want just one or two tones to sound in a patch, turn the others off and store that setting on a patch. This cuts nonessential use of the Fantom-X’s simultaneous voices.

Playing Single Notes (Monophonic)

When using a patch for a naturally monophonic instrument such as sax or flute, it is effective to play in mono.

1. Press [PATCH/RHYTHM] to access the Patch Play screen.
2. Press [F7 (Part Kbd)] to move the cursor to the keyboard part.
3. Press [PATCH EDIT] to access the Patch Edit screen.
4. Press [F1 (\uparrow)] or [F2 (\downarrow)] to select the “Solo/Porta” tab. A screen like the one shown below appears.



5. Press \blacktriangle or \blacktriangledown to move the cursor to “MONO (Solo/Poly).”
6. Turn the VALUE dial or press [DEC] to select “MONO.” Now you can play in mono mode.

TIP

If you assign “Mono/Poly” as a function to be controlled by the assignable switch ([\square^1]/[\square^e]), you can easily switch between mono/poly by pressing a button (p. 125).

Creating Smooth Pitch Changes (Portamento)

Portamento is an effect which smoothly changes the pitch from the first-played key to the next-played key. By applying portamento when Mono mode is selected (see the preceding item), you can simulate performance effects such as slurring on a violin.

1. Press [PATCH/RHYTHM] to access the Patch Play screen.
2. Press [F7 (Part Kbd)] to move the cursor to the keyboard part.
3. Press [PATCH EDIT] to access the Patch Edit screen.
4. Press [F1 (↑)] or [F2 (↓)] to select the “Solo/Porta” tab. A screen like the one shown below appears.

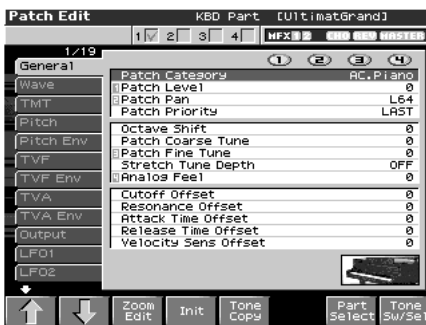

When you press [F7 (Zoom Edit)], the Solo Synth Zoom Edit screen will appear, which displays the above parameters in graphical fashion, simulating an analog synthesizer. To exit from this screen, press [F8 (Exit)] or [EXIT].

5. Press ▲ or ▼ to move the cursor to “Portamento Switch.”
6. Turn the VALUE dial or press [INC] to select “ON.” You’re ready to play portamento.
7. When you want to change the portamento setting, edit the following parameters in the screen of step 6. Portamento Mode, Portamento Type, Portamento Start, Portamento Time



See p. 77 for each parameter’s functions.

8. Press [EXIT] to return to the Patch Play screen and play.



If you assign “Portamento” as a function to be controlled by the assignable switches ([]/[]), you can use a button to easily turn portamento on/off (p. 125).

Selecting the Parameter Controlled by the Realtime Controllers or D Beam Controller (Control Setting)

The Phantom-X lets you assign the parameters that will be affected when you operate the realtime control knobs, assignable switches, D Beam, pitch bend, or modulation lever. This lets you modify the sound in a variety of ways by operating the controllers.

Specifying the Part that Will be Affected by the Controller

You can specify whether operating the controller will affect the sound assigned to the keyboard part or the sound assigned to the pad part.

1. Press [PATCH/RHYTHM] to access the Patch Play screen.
2. Press [F4 (Ctrl Setting)].
3. Press [F7 (Ctrl Part)].

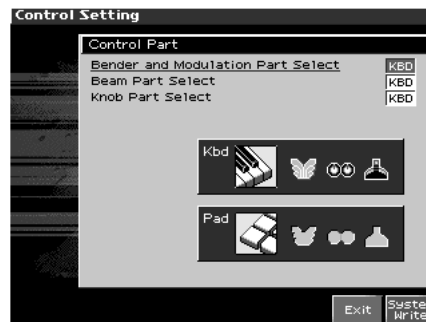

4. Use [CURSOR] to select the parameter.
5. Either turn the VALUE dial or use [INC][DEC] to turn the setting.
6. If you want to keep the settings, press [F8 (System Write)].
7. When you have finished making settings, press [EXIT] to return to the Patch Play screen.

NOTE

When Patch mode is selected, controller settings cannot be saved for each individual patch. Controller settings are saved as system settings.

Bender and Modulation Part Select

Selects the part that will be controlled by pitch bend messages or modulation messages.

Value: KBD, PAD

Beam Part Select

Selects the part that will be controlled by the D Beam.

Value: KBD, PAD

Playing in Patch Mode

Knob Part Select

Selects the part that will be controlled by the realtime control knobs.

Value: KBD, PAD

Assigning a Parameter to a Controller

Here's how to specify the parameter that will be affected when you operate a controller.

1. Press [PATCH/RHYTHM] to access the Patch Play screen.
2. Press [F4 (Ctrl Setting)].



3. Press [F1 (↑)] or [F2 (↓)] to select the parameter.
4. Use [CURSOR] to move the cursor to the parameter.
5. Either turn the VALUE dial or use [INC][DEC] to set the value.
6. If you want to keep the settings, press [F8 (System Write)].

NOTE

When Patch mode is selected, controller settings cannot be saved for each individual patch. Controller settings are saved as system settings.

7. When you have finished making settings, press [EXIT] to return to the Patch Play screen.

You can jump directly to various setting screens by holding down the [SHIFT] and operating the following buttons or knobs.

- Button at the right of the realtime control knobs
- Assignable switch

D Beam (Pad Trigger)

Instead of striking the pads themselves, you can also use the D Beam controller to control the sounding of the pads.

TIP

PAD trigger settings are saved independently for each performance as part of the performance settings. This lets you create performances that make effective use of controller settings.



cf.

For details on these settings, refer to “Assigning a Parameter to a Controller” (p. 48).

Pad Number

Specifies the pad number affected by the D Beam.

When the cursor is located at this parameter, you can also make this setting by striking the desired pad.

Value: 0–16

Pad Velocity

Specifies the strength of the pad sound played by the D Beam controller.

Value: 1–127

Pad Control Mode

This specifies how the D Beam will behave when it is obstructed. If this is set to MOMENTARY, the parameter will be on only while the D Beam is obstructed, and will turn off when you stop obstructing it. If this is set to LATCH, the parameter will alternately be switched on/off each time you obstruct the D Beam.

Value: MOMENTARY, LATCH

D Beam (Solo Synth)

You can use the D Beam controller to perform in a way similar to on a mono synth.



TIP

When you press [F6 (Panel View)], the Panel View screen will appear, which displays the above parameters in graphical fashion, simulating an analog synthesizer. From the Panel View screen, you can press [F2 (Image View)] to open the Image View screen, where you can see a graphical indication of the D Beam output value. Press [EXIT] to return to the Control Setting screen.

cf.

For details on these settings, refer to “Assigning a Parameter to a Controller” (p. 48).

OSC 1/2 Waveform

Select the waveform. **SAW** is a sawtooth wave, and **SQR** is a square wave.

Value: SAW, SQR

OSC 1/2 Pulse Width

Specifies the pulse width of the waveform. By cyclically modifying the pulse width you can create subtle changes in the tone.

* *The Pulse Width is activated when “SQR” is selected with OSC1/2 waveform.*

Value: 0–127

OSC 1/2 Coarse Tune

Adjusts the pitch of the tone’s sound up or down in semitone steps (+/-4 octaves).

Value: -48–+48

OSC 1/2 Fine Tune

Adjusts the pitch of the tone’s sound up or down in 1-cent steps (+/-50 cents).

Value: -50–+50

OSC2 Level

Adjust the OSC2 level.

Value: 0–127

OSC Sync Switch

Turning this switch on produces a complex sound with many harmonics. This is effective when the OSC1 pitch is higher than the OSC2 pitch.

Value: OFF, ON

Filter Type

Selects the type of filter.

OFF: No filter is used.

LPF: Low Pass Filter. This reduces the volume of all frequencies above the cutoff frequency (Cutoff Freq) in order to round off, or un-brighten the sound. This is the most common filter used in synthesizers.

BPF: Band Pass Filter. This leaves only the frequencies in the region of the cutoff frequency (Cutoff Frequency), and cuts the rest. This can be useful when creating distinctive sounds.

HPF: High Pass Filter. This cuts the frequencies in the region below the cutoff frequency (Cutoff Frequency). This is suitable for creating percussive sounds emphasizing their higher tones.

PKG: Peaking Filter. This emphasizes the frequencies in the region of the cutoff frequency (Cutoff Frequency). You can use this to create wah-wah effects by employing an LFO to change the cutoff frequency cyclically.

Cutoff

Selects the frequency at which the filter begins to have an effect on the waveform’s frequency components.

Value: 0–127

Resonance

Emphasizes the portion of the sound in the region of the cutoff frequency, adding character to the sound. Excessively high settings can produce oscillation, causing the sound to distort.

Value: 0–127

Level

Sets the volume.

Value: 0–127

Chorus Send Level

Sets the level of the signal sent to chorus.

Value: 0–127

Reverb Send Level

Sets the level of the signal sent to reverb.

Value: 0–127

LFO Rate

Adjusts the modulation rate, or speed, of the LFO.

Value: 0–127

Playing in Patch Mode

LFO Osc 1 Pitch Depth

Specifies the depth to which the LFO will modulate the OSC1 pitch.

Value: -63+63

LFO Osc 2 Pitch Depth

Specifies the depth to which the LFO will modulate the OSC2 pitch.

Value: -63+63

LFO Osc 1 Pulse Width Depth

Specifies the depth to which the LFO will modulate the pulse width of the OSC1 waveform.

* *The Pulse Width is activated when "SQR" is selected with OSC1/2 waveform.*

Value: -63+63

LFO Osc 2 Pulse Width Depth

Specifies the depth to which the LFO will modulate the pulse width of the OSC2 waveform.

* *The Pulse Width is activated when "SQR" is selected with OSC1/2 waveform.*

Value: -63+63

Range (Solo synth range)

Specifies the range in which the pitch of the solo synth will vary.

Value: 2 OCTAVES, 4 OCTAVES, 8 OCTAVES

D Beam (Assignable)

By assigning a variety of functions to the D Beam controller you can apply different effects to the sound in real time.



cf.

For details on these settings, refer to “Assigning a Parameter to a Controller” (p. 48).

Type

Specifies the function controlled by the D Beam controller.

Value

CC01–31, 33–95: Controller numbers 1–31, 33–95

cf.

For more information about Control Change messages, please refer to “MIDI Implementation” (p. 298).

- Bend Up:** Raises the pitch in semitone steps (up to 4 octaves higher).
- Bend Down:** Lowers the pitch in semitone steps (up to 4 octaves lower).
- Start/stop:** Starts/Stops the sequencer.
- TAP Tempo:** Tap tempo (a tempo specified by the interval at which you move your hand over the D Beam controller).
- Arp Grid:** Arpeggio Grid
- Arp Duration:** Adjusts the duration of each arpeggiated note
- Arp Motif:** Arpeggio Motif
- Arp Oct Up:** The range in which the arpeggio is sounded will rise in steps of an octave (maximum 3 octaves).
- Arp Oct Down:** The range in which the arpeggio is sounded will lower in steps of an octave (maximum 3 octaves).

Range Min (D Beam Range Lower)

Specify the lower limit of the range of the D Beam controller.

Value: 0–127

Range Max (D Beam Range Upper)

Specify the upper limit of the range of the D Beam controller. By setting Range Max below Range Min you can invert the range of change.

Value: 0–127

Knob



cf.

For details on these settings, refer to “Assigning a Parameter to a Controller” (p. 48).

MEMO

Knob parameters are valid only when the REALTIME CONTROL button is set to “ASSIGNABLE.”

Knob Assign 1-4 (Realtime Control Knob Assign 1-4)

Specify the functions that will be controlled by the [] knobs.

Value

CC01-31, 33-95: Controller numbers 1-31, 33-95

cf.

For more information about Control Change messages, please refer to “MIDI Implementation” (p. 298).

- Pitch Bend:** Pitch Bend
- Aftertouch:** Aftertouch
- Arp Style:** Arpeggio Style
- Arp Grid:** Arpeggio Grid
- Arp Duration:** Adjusts the duration of each arpeggiated note
- Arp Motif:** Arpeggio Motif
- Chord Form:** Chord Form
- Master Level:** The volume of the entire Fantom-X.
* *Master Level adjusts the volume both of the OUTPUT A jacks and the DIGITAL OUT jack. The front panel VOLUME knob only adjusts the volume of the OUTPUT A jacks.*
- Arp Step:** Controls the playback position of the arpeggio pattern.
- Digital In:** Input level from DIGITAL IN.

Switch

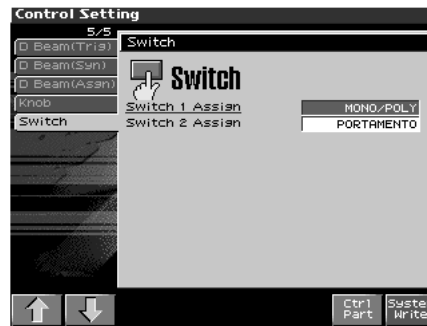

cf.

For details on these settings, refer to “Assigning a Parameter to a Controller” (p. 34).

NOTE

Assignable switches are valid only when the keyboard part is selected.

Switch 1/2 (Assignable Switch 1-2)

Specify the functions that will be controlled by the []/[] buttons.

Value

- Transpose Down:** Lowers the key range in semitone steps (up to 5 semitones lower).
- Transpose Up:** Raises the key range in semitone steps (up to 6 semitones higher).
* *Normally, the Transpose Down/Up functions are assigned to switches 1/2.*
- Tap Tempo:** Tap tempo (a tempo specified by the interval at which you press the button).
- Mono/Poly:** Pressed to toggle between polyphonic (POLY) and monophonic (MONO) play of a patch.
Indicator lit = Mono
Indicator unlit = Poly
- Portamento:** Portamento On/Off
- Hold:** Hold play On/Off
- MFx1-3 Sw:** Multi-effect 1-3 switch
- Chorus Sw:** Chorus switch
- Reverb Sw:** Reverb switch
- Mastering Sw:** Mastering switch
- Loop:** Loop play On/Off
- Rhythm Start/Stop:** Rhythm pattern playback On/Off

Playing in Patch Mode

Playing Percussion Instruments

In Patch mode, you can play percussion instruments from the keyboard and pad by selecting a rhythm set. As the rhythm tone assigned to each key and pad varies by the rhythm set selected, you can play a wide range of percussion instruments.

Selecting a Rhythm Set

The Fantom-X has four rhythm set groups, including the User group, Preset group and GM group, with 32 rhythm sets in the User group, 40 rhythm sets in Preset group, and 9 rhythm sets in GM group. Rhythm sets can also be saved on a memory card. What's more, you can further expand your options by installing up to three optional Wave Expansion Boards (SRX series; sold separately), enabling you to select from a large selection of rhythm sets.

USER

This is the group inside the Fantom-X which can be rewritten. The rhythm sets you create can be stored in this group. The Fantom-X includes 32 rhythm sets.

PRST (Preset)

This is the group inside the Fantom-X which cannot be rewritten. However, you can modify the settings of the currently selected rhythm set, and then save the modified settings in User memory. The Fantom-X contains 40 preset rhythm sets.

CARD (Memory Card)

This group lets you use patches stored on a memory card inserted in the rear panel card slot. Since the data in this group can be rewritten, you can use this group to store patches that you create.

GM (GM2)

This is an internal group of rhythm sets compatible with General MIDI 2, a system of MIDI function specifications designed to transcend differences between makers and types of devices; these rhythm sets cannot be overwritten. Furthermore, settings of currently selected rhythm sets from this group cannot be changed. The Fantom-X includes nine preset rhythm sets.

XP-A-D (Wave Expansion Boards installed in EXP-A-D Slots)

These groups are for when using rhythm sets from a Wave Expansion Board installed in slots EXP A-D, and cannot be rewritten. However, you can modify the settings of the currently selected rhythm set, and then save the modified settings in User memory and Memory card. The number of onboard rhythm sets depends on the specific Wave Expansion Boards installed.

NOTE

A Rhythm Set XP-A-D cannot be accessed if the Wave Expansion Board (SRX series; sold separately) it belongs to has not been installed.

1. Press [PATCH/RHYTHM] to access the Patch Play screen.
2. Press [F7 (Part Kbd)] or [F8 (Part Pad)] to select the pad part or the keyboard part.



- * Make sure that the Patch Type is set to "Rhythm." If this is set to "Patch," use [CURSOR] to move the cursor to the switch, and turn the VALUE dial or press [INC] to select "Rhythm."

3. Press ◀ to move the cursor to the rhythm set group.
4. Turn the VALUE dial or press [INC]/[DEC] to select the rhythm set group.
USER: User
PRST: Preset
CARD: Memory card
GM: Preset GM (GM2)
XP-A-D: Wave Expansion Boards installed in EXP-A-D Slots
5. Press ▶ to move the cursor to the rhythm set number.
6. Turn the VALUE dial or press [INC]/[DEC] to select the rhythm set number.
7. If you selected a rhythm set for the pad part, play the pads to hear the sound. If you selected a rhythm set for the keyboard part, play the keyboard to hear the sound.

TIP

You can select favorite rhythm sets in the same way as when selecting patches. For details on the procedure, refer to "Selecting Favorite Patches" (p. 28).

Playing a Rhythm Set

1. Press [PATCH/RHYTHM] to access the Patch Play screen, and then press [F6].

The Patch Play screen switches.

2. Press [F7 (Part Kbd)] or [F8 (Part Pad)] to select the part. Select the rhythm set that you wish to play.

3. Press a key or a pad on the keyboard to play a percussion instrument.

Below the rhythm set name, the screen shows the note name of the key you pressed, and the name of the percussion instrument (rhythm tone name) assigned to that key.



Note name
Rhythm tone name

Playing in Piano Mode

The Fantom-X has a Piano mode that use the instrument as a dedicated piano. This chapter explains the procedures used in piano mode, and the functions of the parameters.

Cautions for Piano mode

- If you want to edit a patch, switch to Patch mode.
- If you use a Hold pedal, we recommend that you use a Roland DP-8. If the DP-8 is used, you can control the amount of resonance by the depth to which you press the pedal.

Selecting Piano Mode

1. Press **[PIANO MODE]**.

The Piano Mode screen appears.



Selecting a Patch

In Piano mode you can select piano-type sounds.

1. Press **◀** or **▶** to move the cursor to the patch name.
2. Turn the VALUE dial or press **[INC]/[DEC]** to select the patch.

NOTE

In Piano mode you cannot select patches from the GM group.

Selecting Patches by Category

The Fantom-X provides a "Patch Search function" (Patch Finder) which allows you to specify a type (category) of patch so that you can quickly find the desired patch.

1. Press **◀** or **▶** to move the cursor to the patch category.
2. Turn VALUE dial of press **[INC]/[DEC]** to select the patch category.

You can choose from two categories: "PNO" (acoustic piano) and "EP" (electric piano).

Selecting from the Patch List Screen

You can display a list of piano patches and select a patch from that list.

1. In the Piano Mode screen, press **[F1 (List)]**.



2. Press **▲** or **▼** to select the patch.
3. Press **[F1 (↑)]** or **[F2 (↓)]** to select the desired category.
4. Turn the VALUE dial or press **[INC]/[DEC]**, and then press **[F8 (Select)]** to select the patch.

TIP

By pressing **[F7 (Preview)]** you can audition a patch using a preselected phrase appropriate for that type (category) of patch (Phrase Preview).

MEMO

By pressing **[F6 (System Write)]** you can register the currently selected patch as the one that will be first selected the next time you press **[PIANO MODE]** to enter Piano mode.

Playing acoustic piano sounds

When you select acoustic piano, the multi-effect setting will be "78:SYMPATHETIC RESONANCE."

Adjusting the Keyboard Touch (Key Touch)

You can vary the touch of the keyboard when you play the keys.

1. In the Piano Mode screen press **[F2 (Key Touch)]**.



- Use the VALUE dial or [DEC][INC] to specify the desired touch.
 - Light:** This sets the keyboard to a light touch. You can achieve fortissimo (ff) play with a less forceful touch than usual, so the keyboard feels lighter. This setting makes it easier for children, whose hands have less strength.
 - Medium:** This sets the keyboard to the standard touch. You can play with the most natural touch. This setting is closest to the response of an acoustic piano.
 - Heavy:** This sets the keyboard to a heavy touch. You have to play the keyboard more forcefully than usual in order to play fortissimo (ff), so the keyboard touch feels heavier. This setting allows you to add more expression when playing dynamically.

Changing the Piano Sound (Open/Close)

- In the Piano Mode screen, press [F3 (Open/Close)].



- Use the VALUE dial or [DEC][INC] to change the setting, simulating the way in which the sound changes when you open or close the lid of a grand piano.
Value: 1–6

Adjusting the Depth of Resonance (Resonance)

When you hold down the damper pedal on an acoustic piano, the strings (notes) you play will cause the other strings to resonate sympathetically, creating a rich and spacious resonance. You can adjust the depth of this resonance.

- From the Piano Mode screen, press [F4 (Resonance)].



- Either turn the VALUE dial or use [INC] [DEC] to set the value.

Playing electric piano sounds

Selecting electric piano effects



You can press a button [F4]–[F8] to access multi-effects that are frequently used on electric pianos.

Knobs 1–4 displayed in the screen correspond to REALTIME CONTROL knobs 1–4.

[F4 (Tremolo)]:	Tremolo
[F5 (Chorus)]:	Chorus
[F6 (Phaser)]:	Phaser
[F7 (EQ)]:	Equalizer
[F8 (Speaker SIM)]:	Speaker simulator

Saving a Sound (Patch)

Changes you make to sound settings are temporary, and will be lost if you turn off the power or select another sound. If you want to keep the modified sound, you must save it in the internal USER group (user memory). Refer to “Saving Patches You’ve Created (Write)” (p. 59).

Creating a Patch

With the Fantom-X, you have total control over a wide variety of settings. Each item that can be set is known as a **parameter**. When you change the values of parameters, you are doing what is referred to as **Editing**. This chapter explains the procedures used in creating patches, and the functions of the patch parameters.

How to Make Patch Settings

Start with an existing patch and edit it to create a new patch. Since a patch is a combination of up to any four tones, you should listen to how the individual tones sound before you edit.

Four Tips for Editing Patches

- **Select a patch that is similar to the sound you wish to create** (p. 39).
It's hard to create a new sound that's exactly what you want if you just select a patch and modify its parameters at random. It makes sense to start with a patch whose sound is related to what you have in mind.
- **Decide which tones will sound** (p. 46).
When creating a patch, it is important to decide which tones you are going to use. In the Patch Edit screen, set Tone Switch 1–4 to specify whether each tone will sound (on), or not (off). It is also important to turn off unused tones to avoid wasting voices, unnecessarily reducing the number of simultaneous notes you can play.
- **Check the Structure setting** (p. 63).
The important Structure parameter determines how the four tones combine. Before you select new tones, make sure you understand how the currently selected tones are affecting each other.
- **Turn Effects off** (p. 206).
Since the Fantom-X effects have such a profound impact on its sounds, turn them off to listen to the sound itself so you can better evaluate the changes you're making. Since you will hear the original sound of the patch itself when the effects are turned off, the results of your modifications will be easier to hear. Actually, sometimes just changing effects settings can give you the sound you want.

1. Press [PATCH/RHYTHM] to access the Patch Play screen, and select the part (keyboard part or pad part) and patch whose settings you want to edit (p. 39).

NOTE

You cannot edit the patches in the GM2 group.

TIP

If you want to create a patch from scratch (rather than starting from an existing patch), execute the **Initialize** operation (p. 57).

2. Press [PATCH EDIT].

The Patch Edit screen appears.



3. The parameters are organized into several editing groups. Press [F1 (↑)] or [F2 (↓)] to select the tab for the editing group that contains the parameter you wish to edit.



For details on how the parameters are grouped, refer to “Patch Parameter” (p. 255).

- **To change the part that you want to edit**
Press [F7 (Part Select)].
4. Press ▲ or ▼ to move the cursor to the parameter you wish to modify.
 5. Press [F8 (Tone Sw/Sel)] to select the tone that you want to edit.
The Tone Sw Select window appears.

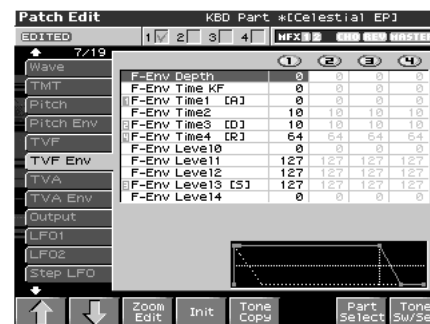

Press any one of the [F5 (Tone Select)]–[F8 (Tone Select)] buttons to select the tone that you want to edit.

- **Simultaneously editing the same parameter of multiple tones**
To select the tones you want to edit at the same time, simultaneously press two or more of the [F5 (Tone Select)]–[F8 (Tone Select)] buttons, making them light red.
 - **To switch a tone on/off**
Press a [F1 (Tone Sw)]–[F4 (Tone Sw)] button to switch the corresponding tone on/off.
- * You can also select the tone by pressing ◀ or ▶. You can also hold down [SHIFT] and press [F1]–[F8] to select a tone to edit or to switch a tone on/off.
6. When you have made your selection, press [EXIT].
 7. Turn the VALUE dial or press [INC]/[DEC] to get the value you want.
If you've selected two or more tones, your editing will modify the parameter values for all selected tones by the same amount.

8. Repeat steps 5-7 to set each parameter you want to edit.
9. If you wish to save the changes you've made, press [WRITE] to perform the Save operation (p. 59). If you do not wish to save changes, press [EXIT] to return to the Patch Play screen.

If you return to the Patch Play screen without saving, an "*" will be displayed at the left of the patch number, indicating that the patch settings have been edited.

NOTE

If you turn off the power or select a different sound while the display indicates "*", your edited patch will be lost.

TIP

In stead of using [F1] or [F2] in the patch edit screen, you can also select the edit group by holding down [SHIFT] and pressing ▲ or ▼. It is convenient to use this feature when the Tone SW/Select window is displayed.

Editing in a Graphic Display (Zoom Edit)

You can edit while viewing a graphic display of the most frequently used important parameters. Zoom Edit lets you edit the following parameters.

Parameter	page	Parameter	page
Pitch Envelope	p. 68	Structure Type	p. 63
TVF	p. 69	LFO 1/2	p. 74
TVF Envelope	p. 71	Step LFO	p. 74
TVA Envelope	p. 72		

1. Press [PATCH/RHYTHM] to access the Patch Play screen, and select the part (keyboard part or pad part) and patch that you want to edit.
2. Press [PATCH EDIT], and then press [F3 (Zoom Edit)].
The Zoom Edit screen will appear.



3. The parameters are organized into several edit groups. Press [F1]–[F4] to select the tab for the parameters that you want to edit.
 - To switch the parameter you want to edit
Press [F6].
 - To switch to a different part for editing
Press [F7 (Part Select)].
 - To select a tone for editing or switch a tone on/off
Press [F8 (Tone Sw/Sel)].

4. Use [CURSOR] to move the cursor to the parameter that you want to edit.
You can use the realtime control knob to set the value.
5. Turn the VALUE dial or use [INC][DEC] to modify the value.
6. When you have finished editing, press [EXIT].

Initializing Patch Settings (Init)

"Initialize" means to return the settings of the currently selected sound to a standard set of values.

NOTE

The Initialize operation will affect only the currently selected sound; the sounds that are stored in user memory will not be affected. If you wish to restore all of the Fantom-X's settings to their factory values, perform a Factory Reset (p. 235).

1. Press [PATCH/RHYTHM] to access the Patch Play screen, and select the part (keyboard part or pad part) and patch that you want to initialize (p. 39).
2. Hold down [SHIFT] and press [F1 (Init)].
A message will ask you for confirmation.
3. Press [F8 (Exec)].
The initialization will be carried out, and you'll be returned to the previous screen.
To cancel, press [F7 (Cancel)].

Copying Patch (Tone) Settings (Copy)

This operation copies the settings of any desired patch to the currently selected patch. You can use this feature to make the editing process faster and easier.

1. Press [PATCH/RHYTHM] to access the Patch Play screen, and select the part (keyboard part or pad part) that you want to edit and the copy-destination patch (p. 39).

2. Press [PATCH EDIT].

3. Press [F5 (Tone Copy)].

The Patch Copy window appears.



4. Press [CURSOR] to move the cursor, select the “Source (copy-source)” group and number, and patch/tone.

5. Turn the VALUE dial or use [INC][DEC] to make settings.

6. Press [CURSOR] to move the cursor, select the “Destination (copy-destination)” patch/tone/number.

7. Turn the VALUE dial or use [INC][DEC] to make settings.

8. Press [F8 (Exec)].

A message will ask you for confirmation.

9. Press [F8 (Exec)] to return to the Patch Edit screen.

To cancel, press [F7 (Cancel)].

The Compare Function

For the Patch Effect Copy and Patch Tone Copy operations, you can use the Compare function.

If you want to play the copy-source patch, press [F6 (Compare)] to light it into red.

Now you can play the copy-source patch from the keyboard or pads.



NOTE

The patch auditioned using the Compare function may sound slightly different than when it is played normally.

Cautions When Selecting a Waveform

The sounds of the Fantom-X are based on complex PCM waveforms, and if you attempt to make settings that are contrary to the type of the original waveform, the results will not be as you expect.

The internal waveforms of the Fantom-X fall into the following two groups.

One-shot: These waveforms contain sounds that have short decays. A one-shot waveform records the initial rise and fall of the sound. Some of the Fantom-X's one-shot waveforms are sounds that are complete in themselves, such as percussive instrument sounds. The Fantom-X also contains many other one-shot waveforms that are elements of other sounds. These include attack components such as piano-hammer sounds and guitar fret noises.

Looped: These waveforms include sounds with long decays as well as sustained sounds. Loop waveforms repeatedly play back (loop) the portion of the waveform after the sound has reached a relatively steady state. The Fantom-X's looped waveforms also include components of other sounds, such as piano-string resonant vibrations and the hollow sounds of brass instruments.

The following diagram shows an example of sound (electric organ) that combines one-shot and looped waveforms.

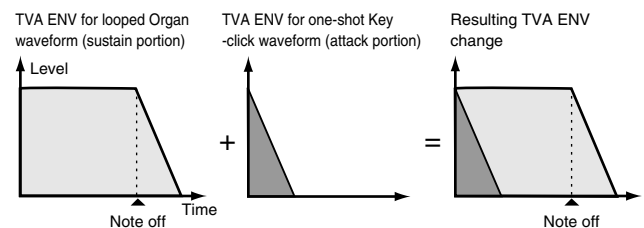

Cautions When Using a One-shot Waveform

It is not possible to use the envelope to modify a one-shot waveform to create a decay that is longer than the original waveform, or to turn it into a sustaining sound. If you were to program such an envelope, you would be attempting to shape a portion of the sound that simply doesn't exist, and the envelope would have no effect.

Cautions When Using a Loop Waveform

With many acoustic instruments such as piano and sax, extreme timbral changes occur during the first few moments of each note. This initial attack is what defines much of the instrument's character. For such waveforms, it is best to use the complex tonal changes of the attack portion of the waveform just as they are, and to use the envelope only to modify the decay portion. If you attempt to use the envelope to modify the attack portion as well, the characteristics of the original waveform may prevent you from getting the sound that you intend.

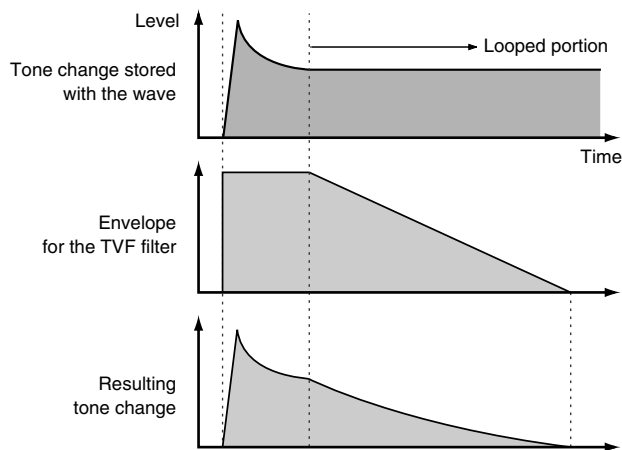

Saving Patches You've Created (Write)

Changes you make to sound settings are temporary, and will be lost if you turn off the power or select another sound. If you want to keep the modified sound, you must save it in the internal USER group (user memory)

When you edit the patch settings, an "*" will appear in the Patch Play screen.

NOTE

When you perform the save procedure, the data that previously occupied the save destination will be lost.

1. Make sure that the patch you wish to save is selected.
2. Press [WRITE].

The Write Menu screen appears.

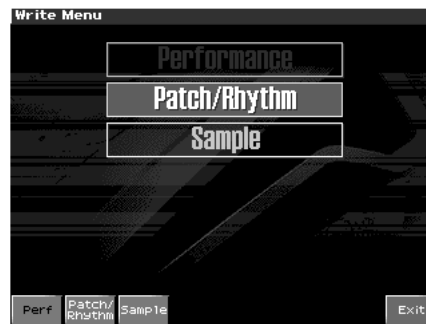

3. Press [F2 (Patch/Rhythm)].

* Alternatively, you can use ▲ or ▼ to select "Patch/Rhythm," and then press [ENTER].

The Patch Write screen appears.



4. Assign a name to the patch.



For details on assigning names, refer to "Assigning a Name" (p. 36)

5. When you have finished inputting the name, press [F8 (Write)].

A screen will appear, allowing you to select the write-destination patch.

Creating a Patch

6. Turn the VALUE dial or use [INC][DEC] and [F2 (↑)][F3 (↓)] to select the write destination and patch number.

The write destination can be either the Fantom-X's internal user area (User), or a memory card (Card).

TIP

By pressing [F6 (Compare)] you can check the save-destination patch (Compare function).

7. Press [F8 (Write)].

A message will ask you for confirmation.

NOTE

Never switch off the Fantom-X while data is being saved.

8. Press [F8 (Exec)] to execute the save operation.

* To cancel the operation, press [F7 (Cancel)].

Auditioning the Save-Destination Patch (Compare)

Before you save a patch, you can audition the patch which currently occupies the save destination to make sure that it is one you don't mind overwriting. This can help prevent important patches from being accidentally overwritten and lost.

- Follow the procedure in "Saving Patches You've Created (Write)" through step 6 to select the save destination.
- Press [F6 (Compare)] to light it into red.

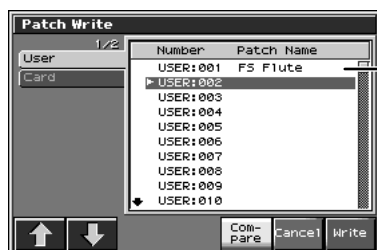

- Play the keyboard or pad to sound the save destination patch, then check whether you really want to overwrite it.

NOTE

The patch auditioned using the Compare function may sound slightly different than when it is played normally.

- If you wish to change the save destination, re-specify the save-destination patch by using ▲ or ▼.
- Press [F8 (Write)].
A message will ask you for confirmation.
- Press [F8 (Exec)] once again to execute the Save operation.

Functions of Patch Parameters

This section explains the functions the different patch parameters have, as well as the composition of these parameters.

MEMO

Parameters marked with a "★" can be controlled using specified MIDI messages (Matrix Control). Settings in the Control screen will determine how these parameters are controlled (p. 80).

If a number is displayed for the parameter name, (① , ② , ③ , ④), you can use the realtime controller knob of the corresponding number (the left most knob is number 1, the right most knob is number 4) to set the value.

When you enter the Patch Edit screen, the indicator at the right of the Realtime Control knobs will go out, and the Realtime Control knobs can be used to edit the parameters of the patch or rhythm set. If you once again press the button located at the right of the Realtime Control knobs to make the indicator light, the knobs will control their original functions. When you exit the Patch Edit screen, the indicator will automatically return to its previous lit state.

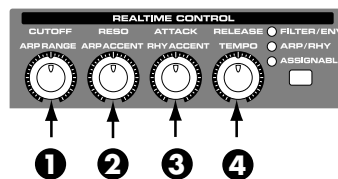

MEMO

You can use the same knobs to edit the values in the Zoom Edit screen as well.

Settings Common to the Entire Patch (General)

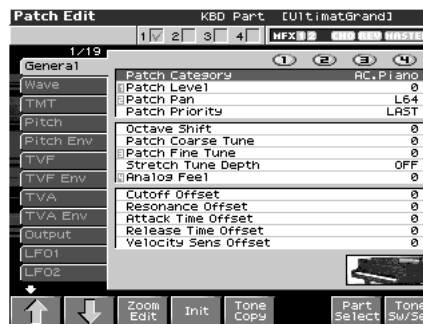

cf.

For details on these settings, refer to "How to Make Patch Settings" (p. 56).

Patch Category

Specifies the type (category) of the patch.

It also determines the phrase that will be sounded when using the Phrase Preview function.



For details on the possible category names, refer to (p. 40).

Patch Level ①

Specifies the volume of the patch.

Value: 0–127

Patch Pan ②

Specifies the pan of the patch. “L64” is far left, “0” is center, and “63R” is far right.

Value: L64–0–63R

Patch Priority

This determines how notes will be managed when the maximum polyphony is exceeded (128 voices).

Value

LAST: The last-played voices will be given priority, and currently sounding notes will be turned off in order, beginning with the first-played note.

LOUDEST: The voices with the loudest volume will be given priority, and currently sounding notes will be turned off, beginning with the lowest-volume voice.

Octave Shift

Adjusts the pitch of the patch’s sound up or down in units of an octave (+/-3 octaves).

Value: -3– +3

Patch Coarse Tune ★

Adjusts the pitch of the patch’s sound up or down in semitone steps (+/-4 octaves).

Value: -48– +48

Patch Fine Tune ③

Adjusts the pitch of the patch’s sound up or down in 1-cent steps (+/-50 cents).

Value: -50– +50



One cent is 1/100th of a semitone.

Stretch Tune Depth

This setting allows you to apply “stretched tuning” to the patch.

(Stretched tuning is a system by which acoustic pianos are normally tuned, causing the lower range to be lower and the higher range to be higher than the mathematical tuning ratios would otherwise dictate.) With a setting of “OFF,” the patch’s tuning will be equal temperament. A setting of “3” will produce the greatest difference in the pitch of the low and high ranges.

Value: OFF, 1–3

The diagram shows the pitch change relative to equal temperament that will occur in the low and high ranges. This setting will have a subtle effect on the way in which chords resonate.

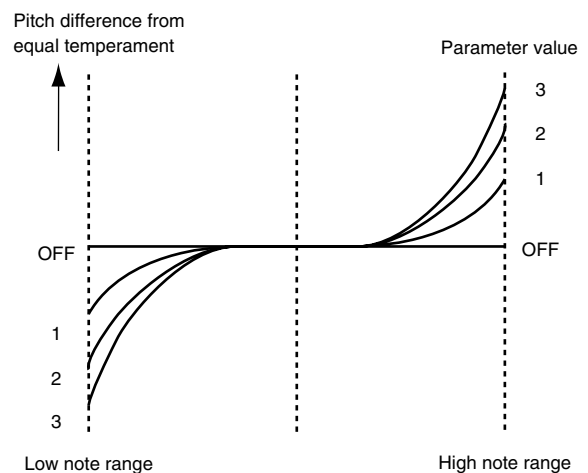

Analog Feel (Analog Feel Depth) ④

Specifies the depth of 1/f modulation that is to be applied to the patch. (1/f modulation is a pleasant and naturally-occurring ratio of modulation that occurs in a babbling brook or rustling wind.)

By adding this “1/f modulation,” you can simulate the natural instability characteristic of an analog synthesizer.

Value: 0–127

Cutoff Offset

Cutoff Frequency Offset alters the cutoff frequency of the overall patch, while preserving the relative differences between the cutoff frequency values set for each tone in the Cutoff Frequency parameters (p. 69).

Range: -63– +63

NOTE

This value is added to the cutoff frequency value of a tone, so if the cutoff frequency value of any tone is already set to “127” (maximum), positive “+” settings here will not produce any change.

Creating a Patch

Resonance Offset

Resonance Offset alters the resonance of the overall patch, while preserving the relative differences between the resonance values set for each tone in the Resonance parameter (p. 69).

Range: -63– +63

- * **Resonance:** *emphasizes the overtones in the region of the cutoff frequency, adding character to the sound.*

NOTE

This value is added to the resonance value of a tone, so if the resonance value of any tone is already set to “127” (maximum), positive “+” settings here will not produce any change.

Attack Time Offset

Attack Time Offset alters the attack time of the overall patch, while preserving the relative differences between the attack time values set for each tone in the A-Env Time 1 parameters (p. 73), F-Env Time 1 parameters (p. 71).

Range: -63– +63

- * **Attack Time:** *The time it takes for a sound to reach maximum volume after the key is pressed and sound begun.*

NOTE

This value is added to the attack time value of a tone, so if the attack time value of any tone is already set to “127” (maximum), positive “+” settings here will not produce any change.

Release Time Offset

Release Time Offset alters the release time of the overall patch, while preserving the relative differences between the release time values set for each tone in the A-Env Time 4 parameters (p. 73), F-Env Time 4 parameters (p. 71).

Range: -63– +63

- * **Release Time:** *The time from when you take your finger off the key until the sound disappears.*

NOTE

This value is added to the release time value of a tone, so if the release time value of any tone is already set to “127” (maximum), positive “+” settings here will not produce any change.

Velocity Sens Offset (Velocity Sensitivity Offset)

Velocity Sensitivity Offset alters the Velocity Sensitivity of the overall patch while preserving the relative differences between the Velocity Sensitivity values set for each tone in the parameters below. Cutoff V-Sens parameter (p. 70)

Level V-Sens parameter (p. 71)

Range: -63– +63

- * **Velocity:** *Pressure with which the key is pressed.*

NOTE

This value is added to the velocity sensitivity value of a tone, so if the velocity sensitivity value of any tone is already set to “+63” (maximum), positive “+” settings here will not produce any change.

Modifying Waveforms (Wave)



cf.

For details on these settings, refer to “How to Make Patch Settings” (p. 56).

Wave Group

Selects the group for the waveform that is to be the basis of the tone.

Value

- INT:** Waveforms stored in internal
- EXP:** Waveform stored in a Wave Expansion Board (SRX series) installed in EXP slots.
- SAMP:** Sample waveforms
- MSAM:** Multisample waveforms

NOTE

You cannot select a waveform group of a Wave Expansion Board that is not installed.

Wave Bank

Selects the wave bank.

Value

- When the wave group is EXP:** A–D
- When the wave group is SAMP:** PRST, USER, CARD
- When the wave group is MSAM:** USER, CARD

Wave No. L (Mono) (Wave Number L (Mono) Wave No. R (Wave Number R))

Selects the basic waveform for a tone. Along with the Wave number, the Wave name appears at the lower part of the display.

When in monaural mode, only the left side (L) is specified. When in stereo, the right side (R) is also specified.

Value: —, 1–1228 (The upper limit will depend on the wave group.)

MEMO

If you want to select a left/right pair of Waves, select the left (L) Wave number and then press [F6 (Set Stereo)]; the right (R) (Wave) will be recalled.

- * *When using a multisample in stereo, you must specify the same number for L and R.*

Wave Gain ❶

Sets the gain (amplification) of the waveform. The value changes in 6 dB (decibel) steps—an increase of 6 dB doubles the waveform’s gain. If you intend to use the Booster to distort the waveform’s sound, set this parameter to its maximum value (p. 65).

Value: -6, 0, +6, +12

Wave Tempo Sync

When you wish to synchronize a Phrase Loop to the clock (tempo), set this to “ON.” This is valid only when a separately sold wave expansion board is installed, and a waveform that indicates a tempo (BPM) is selected as the sample for a tone.

Value: OFF, ON

NOTE

If a waveform from a wave expansion board is selected for the tone, turning the Wave Tempo Sync parameter “ON” will cause pitch-related settings (p. 67) and FXM-related settings (p. 63) to be ignored.

- If a sample is selected for a tone, you must first set the BPM (tempo) parameter of the sample.
- If a sample is selected for a tone, Wave Tempo Sync will require twice the normal number of voices.
- When the Wave Tempo Sync parameter is set to “ON,” set the Delay Time parameter (p. 79) to “0.” With other settings, a delay effect will be applied, and you will be not be able to play as you expect.

Phrase Loop

Phrase loop refers to the repeated playback of a phrase that’s been pulled out of a song (e.g., by using a sampler). One technique involving the use of Phrase Loops is the excerpting of a Phrase from a pre-existing song in a certain genre, for example dance music, and then creating a new song with that Phrase used as the basic motif. This is referred to as “Break Beats.”

Realtime Time Stretch

If the wave group is “SAMP” or “MSAM,” and the Wave Tempo Sync parameter is turned “ON,” you can vary the playback speed of the waveform without affecting the pitch.

FXM Switch ❷

This sets whether FXM will be used (ON) or not (OFF).

Value: OFF, ON

FXM

FXM (Frequency Cross Modulation) uses a specified waveform to apply frequency modulation to the currently selected waveform, creating complex overtones. This is useful for creating dramatic sounds or sound effects.

FXM Color ❸

Specifies how FXM will perform frequency modulation. Higher settings result in a grainier sound, while lower settings result in a more metallic sound.

Value: 1–4

FXM Depth ★ ❹

Specifies the depth of the modulation produced by FXM.

Value: 0–16

Changing How a Tone Is Sounded (TMT)

You can use the force with which keys are played, or MIDI messages to control the way each Tone is played. This is referred to as the Tone Mix Table (TMT).

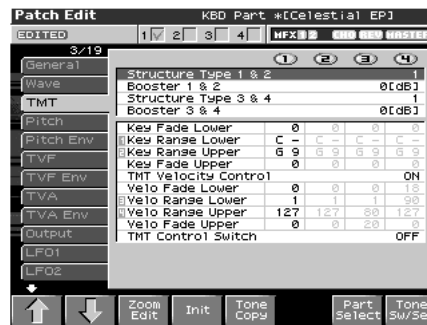

cf.

For details on these settings, refer to “How to Make Patch Settings” (p. 56).

Structure Type 1 & 2, 3 & 4

Determines how tone 1 and 2, or tone 3 and 4 are connected.

Value: 1–10

The following 10 different Types of combination are available.

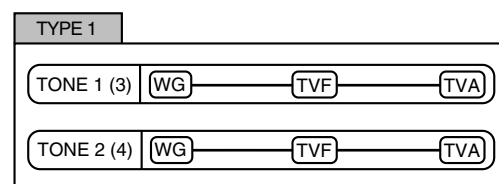

With this type, tones 1 and 2 (or 3 and 4) are independent. Use this type when you want to preserve PCM sounds or create and combine sounds for each tone.

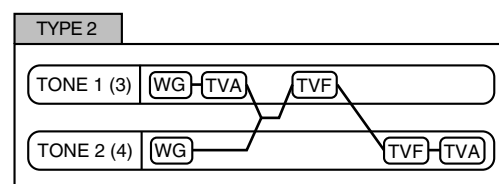

This type stacks the two filters together to intensify the characteristics of the filters. The TVA for tone 1 (or 3) controls the volume balance between the two tones.

Creating a Patch

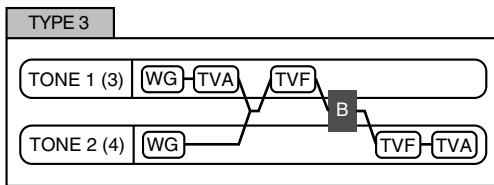

This type mixes the sound of tone 1 (3) and tone 2 (4), applies a filter, and then applies a booster to distort the waveform.

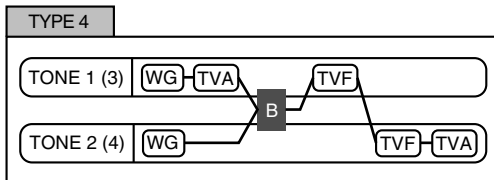

This type applies a booster to distort the waveform, and then combines the two filters. The TVA for tone 1 (or 3) controls the volume balance between the two tones and adjusts booster level.

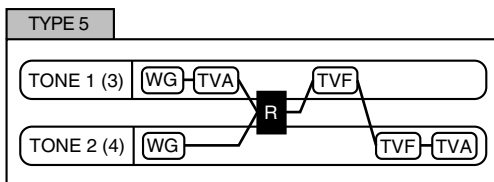

This type uses a ring modulator to create new overtones, and combines the two filters. The tone 1 (3) TVA will control the volume balance of the two tones, adjusting the depth of ring modulator.

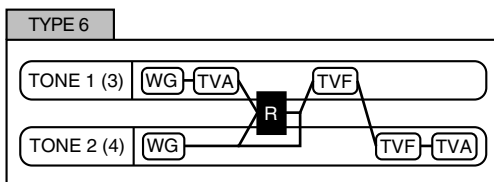

This type uses a ring modulator to create new overtones, and in addition mixes in the sound of tone 2 (4) and stacks the two filters. Since the ring-modulated sound can be mixed with tone 2 (4), tone 1 (3) TVA can adjust the amount of the ring-modulated sound.

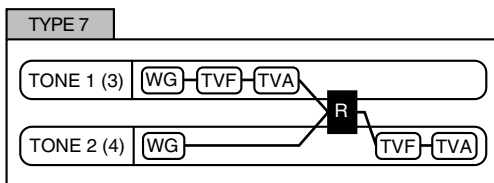

This type applies a filter to tone 1 (3) and ring-modulates it with tone 2 (4) to create new overtones.

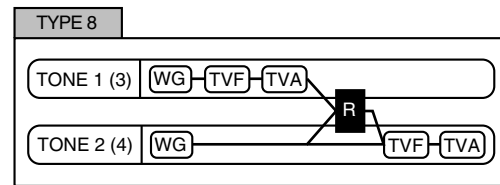

This type sends the filtered tone 1 (3) and tone 2 (4) through a ring modulator, and then mixes in the sound of tone 2 (4) and applies a filter to the result.

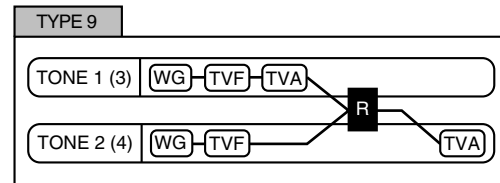

This type passes the filtered sound of each tone through a ring modulator to create new overtones. The tone 1 (3) TVA will control the volume balance of the two tones, adjusting the depth of ring modulator.

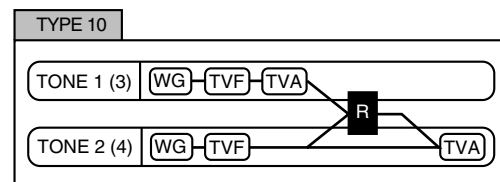

This type passes the filtered sound of each tone through a ring modulator to create new overtones, and also mixes in the sound of tone 2 (4). Since the ring-modulated sound can be mixed with tone 2 (4), tone 1 (3) TVA can adjust the amount of the ring-modulated sound.

NOTE

- When TYPE 2–10 is selected and one tone of a pair is turned off, the other tone will be sounded as TYPE 1 regardless of the displayed setting.
- If you limit the keyboard area in which a tone will sound (Keyboard Range p. 65) or limit the range of velocities for which it will sound (Velocity Range p. 66), the result in areas or ranges where the tone does not sound is just as if the tone had been turned off. This means that if TYPE 2–10 is selected and you create a keyboard area or velocity range in which one tone of a pair does not sound, notes played in that area or range will be sounded by the other tone as TYPE 1 regardless of the displayed setting.

Booster 1&2, 3&4 (Booster Gain)

When a Structure Type of TYPE 3 or TYPE 4 is selected, you can adjust the depth of the booster. The booster increases the input signal in order to distort the sound. This creates the distortion effect frequently used with electric guitars. Higher settings will produce more distortion.

Value: 0, +6, +12, +18

Booster

The Booster is used to distort the incoming signal.

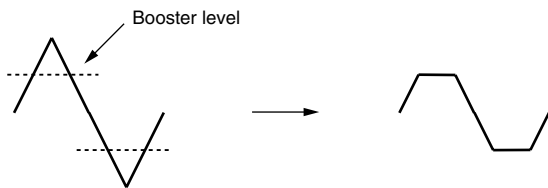

In addition to using this to create distortion, you can use the waveform (WG1) of one of the tones as an LFO which shifts the other waveform (WG2) upward or downward to create modulation similar to PWM (pulse width modulation). This parameter works best when you use it in conjunction with the Wave Gain parameter (p. 63).

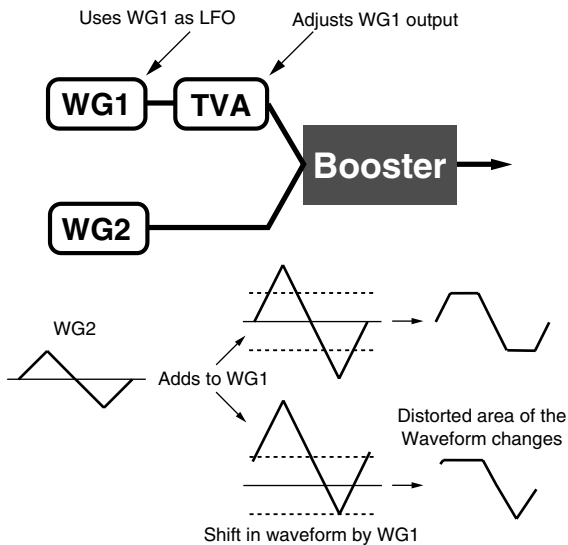

Ring Modulator

A ring modulator multiplies the waveforms of two tones with each other, generating many new overtones (in harmonic partials) which were not present in either waveform. (Unless one of the waveforms is a sine wave, evenly-spaced frequency components will not usually be generated.)

As the pitch difference between the two waveforms changes the harmonic structure, the result will be an unpitched metallic sound. This function is suitable for creating metallic sounds such as bells.

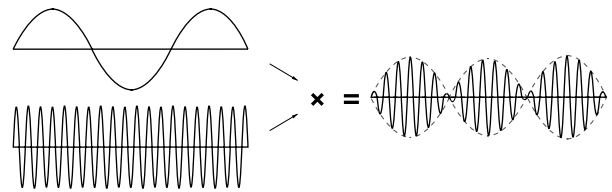

Key Fade Lower (Keyboard Fade Width Lower)

This determines what will happen to the tone's level when a note that's lower than the tone's specified keyboard range is played. Higher settings produce a more gradual change in volume. If you don't want the tone to sound at all when a note below the keyboard range is played, set this parameter to "0."

Value: 0-127

Key Range Lower (Keyboard Range Lower)

①

Specifies the lowest note that the tone will sound for each tone.

Value: C-1-UPPER

Key Range Upper (Keyboard Range Upper)

②

Specifies the highest note that the tone will sound for each tone.

Value: LOWER-G9

NOTE

If you attempt to raise the lower key higher than the upper key, or to lower the upper key below the lower key, the other value will be automatically modified to the same setting.

Creating a Patch

Key Fade Upper (Keyboard Fade Width Upper)

This determines what will happen to the tone's level when a note that's higher than the tone's specified keyboard range is played. Higher settings produce a more gradual change in volume. If you don't want the tone to sound at all when a note below the keyboard range is played, set this parameter to "0."

Value: 0–127

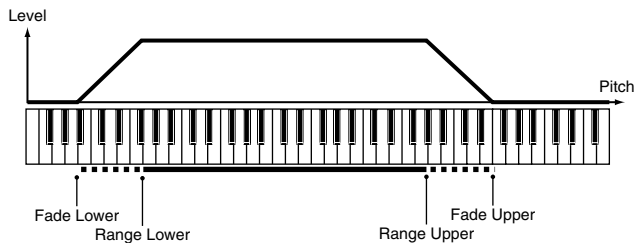

TMT Velocity Control (TMT Velocity Control Switch)

TMT Velocity Control determines whether a different tone is played (ON) or not (OFF) depending on the force with which the key is played (velocity).

When set to "RANDOM," the patch's constituent tones will sound randomly, regardless of any Velocity messages.

When set to "CYCLE," the patch's constituent tones will sound consecutively, regardless of any Velocity messages.

Value: OFF, ON, RANDOM, CYCLE

NOTE

Instead of using Velocity, you can also have tones substituted using the Matrix Control (p. 66). However, the keyboard velocity and the Matrix Control cannot be used simultaneously to make different tones to sound. When using the Matrix Control to switch tones, set the Velocity Control parameter to "OFF."

Velo Fade Lower (Velocity Fade Width Lower)

This determines what will happen to the tone's level when the tone is played at a velocity lower than its specified velocity range. Higher settings produce a more gradual change in volume. If you want notes played outside the specified key velocity range to not be sounded at all, set this to "0."

Value: 0–127

Velo Range Lower (Velocity Range Lower) ③

This sets the lowest velocity at which the tone will sound. Make these settings when you want different tones to sound in response to notes played at different strengths.

Value: 1–UPPER

Velo Range Upper (Velocity Range Upper) ④

This sets the highest velocity at which the tone will sound. Make these settings when you want different tones to sound in response to notes played at different strengths.

Value: LOWER–127

NOTE

If you attempt to set the Lower velocity limit above the Upper, or the Upper below the Lower, the other value will automatically be adjusted to the same setting.

MEMO

When using the Matrix Control to have different tones played, set the lowest value (Lower) and highest value (Upper) of the value of the MIDI message used.

Velo Fade Upper (Velocity Fade Width Upper)

This determines what will happen to the tone's level when the tone is played at a velocity greater than its specified velocity range. Higher settings produce a more gradual change in volume. If you want notes played outside the specified key velocity range to not be sounded at all, set this to "0."

Value: 0–127

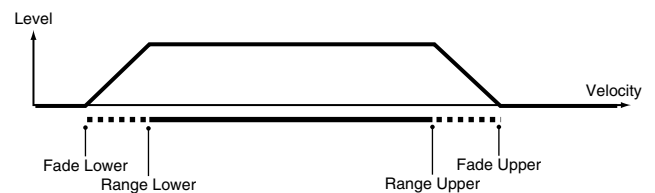

TMT Control Sw (TMT Control Switch)

Use the Matrix Control to enable (ON), or disable (OFF) sounding of different tones.

Value: OFF, ON

NOTE

You can also cause different tones to sound in response to notes played at different strengths (velocity) on the keyboard (p. 66). However, the Matrix Control and the keyboard velocity cannot be used simultaneously to make different tones to sound. When you want to make the different tones to sound, set the Velocity Control parameter (p. 66) to "OFF."

Modifying Pitch (Pitch/Pitch Env)

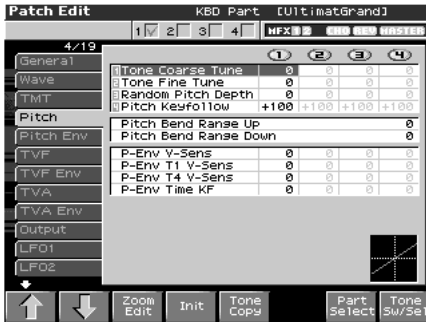

cf.

For details on these settings, refer to “How to Make Patch Settings” (p. 56).

Pitch

Tone Coarse Tune ★ ①

Adjusts the pitch of the tone’s sound up or down in semitone steps (+/-4 octaves).

Value: -48- +48

Tone Fine Tune ★ ②

Adjusts the pitch of the tone’s sound up or down in 1-cent steps (+/-50 cents).

Value: -50- +50

MEMO

One cent is 1/100th of a semitone.

Random Pitch Depth ③

This specifies the width of random pitch deviation that will occur each time a key is pressed. If you do not want the pitch to change randomly, set this to “0.” These values are in units of cents (1/100th of a semitone).

Value: 0, 1, 2, 3, 4, 5, 6, 7, 8, 9, 10, 20, 30, 40, 50, 60, 70, 80, 90, 100, 200, 300, 400, 500, 600, 700, 800, 900, 1000, 1100, 1200

Pitch Key follow ④

This specifies the amount of pitch change that will occur when you play a key one octave higher (i.e., 12 keys upward on the keyboard). If you want the pitch to rise one octave as on a conventional keyboard, set this to “+100.” If you want the pitch to rise two octaves, set this to “+200.” Conversely, set this to a negative value if you want the pitch to fall. With a setting of “0,” all keys will produce the same pitch.

Value: -200, -190, -180, -170, -160, -150, -140, -130, -120, -110, -100, -90, -80, -70, -60, -50, -40, -30, -20, -10, 0, +10, +20, +30, +40, +50, +60, +70, +80, +90, +100, +110, +120, +130, +140, +150, +160, +170, +180, +190, +200

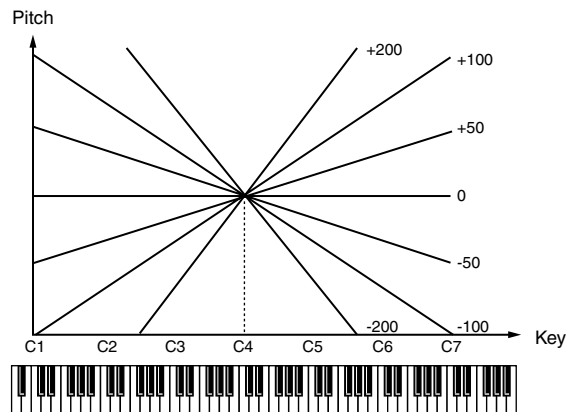

Bend Range Up (Pitch Bend Range Up)

Specifies the degree of pitch change in semitones when the Pitch Bend lever is all the way right. For example, if this parameter is set to “12,” the pitch will rise one octave when the pitch bend lever is moved to the right-most position.

Value: 0- +48

Bend Range Down (Pitch Bend Range Down)

Specifies the degree of pitch change in semitones when the Pitch Bend lever is all the way left. For example if this is set to “-48” and you move the pitch bend lever all the way to the left, the pitch will fall 4 octaves.

Value: -48-0

P-Env V-Sens (Pitch Envelope Velocity Sensitivity)

Keyboard playing dynamics can be used to control the depth of the pitch envelope. If you want the pitch envelope to have more effect for strongly played notes, set this parameter to a positive (+) value. If you want the pitch envelope to have less effect for strongly played notes, set this to a negative (-) value.

Value: -63- +63

P-Env T1 V-Sens (Pitch Envelope Time 1 Velocity Sensitivity)

This allows keyboard dynamics to affect the Time 1 of the Pitch envelope. If you want Time 1 to be speeded up for strongly played notes, set this parameter to a positive (+) value. If you want it to be slowed down, set this to a negative (-) value.

Value: -63- +63

Creating a Patch

P-Env T4 V-Sens (Pitch Envelope Time 4 Velocity Sensitivity)

Use this parameter when you want key release speed to affect the Time 4 value of the pitch envelope. If you want Time 4 to be speeded up for quickly released notes, set this parameter to a positive (+) value. If you want it to be slowed down, set this to a negative (-) value.

Value: -63- +63

P-Env Time KF (Pitch Envelope Time Key Follow)

Use this setting if you want the pitch envelope times (Time 2–Time 4) to be affected by the keyboard location. Based on the pitch envelope times for the C4 key, positive (+) settings will cause notes higher than C4 to have increasingly shorter times, and negative (-) settings will cause them to have increasingly longer times. Larger settings will produce greater change.

Value: -100, -90, -80, -70, -60, -50, -40, -30, -20, -10, 0, +10, +20, +30, +40, +50, +60, +70, +80, +90, +100

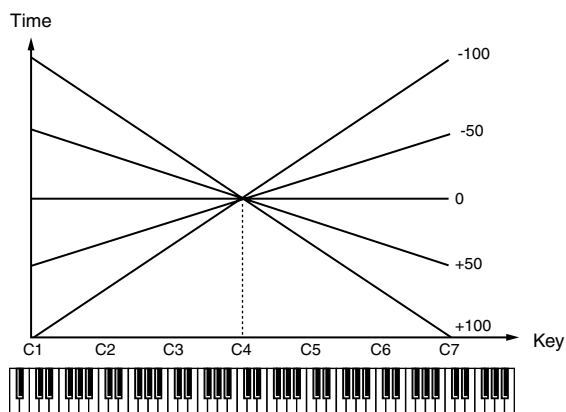

Pitch Env

P-Env Depth (Pitch Envelope Depth) ①, ②, ④

Adjusts the effect of the Pitch Envelope. Higher settings will cause the pitch envelope to produce greater change. Negative (-) settings will invert the shape of the envelope.

Value: -12- +12

P-Env Time 1-4 (Pitch Envelope Time 1-4) ★ ③

Specify the pitch envelope times (Time 1–Time 4). Higher settings will result in a longer time until the next pitch is reached. (For example, Time 2 is the time over which the pitch changes from Level 1 to Level 2.)

Value: 0–127

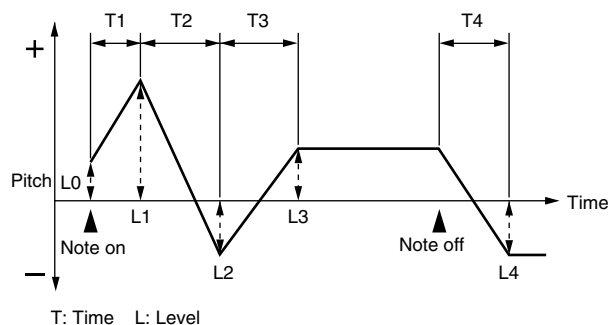

P-Env Level 0-4 (Pitch Envelope Level 0-4)

Specify the pitch envelope levels (Level 0–Level 4). It determines how much the pitch changes from the reference pitch (the value set with Coarse Tune or Fine Tune on the Pitch screen) at each point. Positive (+) settings will cause the pitch to be higher than the standard pitch, and negative (-) settings will cause it to be lower.

Value: -63- +63

Modifying the Brightness of a Sound with a Filter (TVF/TVF Env)

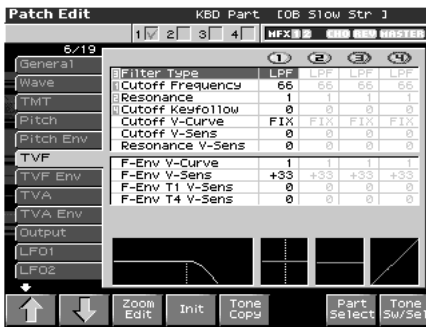

cf.

For details on these settings, refer to “How to Make Patch Settings” (p. 56).

TVF

Filter Type ③

Selects the type of filter. A filter cuts or boosts a specific frequency region to change a sound’s brightness, thickness, or other qualities.

Value

- OFF:** No filter is used.
- LPF:** Low Pass Filter. This reduces the volume of all frequencies above the cutoff frequency (Cutoff Freq) in order to round off, or un-brighten the sound. This is the most common filter used in synthesizers.
- BPF:** Band Pass Filter. This leaves only the frequencies in the region of the cutoff frequency (Cutoff Freq), and cuts the rest. This can be useful when creating distinctive sounds.
- HPF:** High Pass Filter. This cuts the frequencies in the region below the cutoff frequency (Cutoff Freq). This is suitable for creating percussive sounds emphasizing their higher tones.
- PKG:** Peaking Filter. This emphasizes the frequencies in the region of the cutoff frequency (Cutoff Freq). You can use this to create wah-wah effects by employing an LFO to change the cutoff frequency cyclically.
- LPF2:** Low Pass Filter 2. Although frequency components above the Cutoff frequency (Cutoff Freq) are cut, the sensitivity of this filter is half that of the LPF. This makes it a comparatively warmer low pass filter. This filter is good for use with simulated instrument sounds such as the acoustic piano.
- LPF3:** Low Pass Filter 3. Although frequency components above the Cutoff frequency (Cutoff Freq) are cut, the sensitivity of this filter changes according to the Cutoff frequency. While this filter is also good for use with simulated acoustic instrument sounds, the nuance it exhibits differs from that of the LPF2, even with the same TVF Envelope settings.

NOTE

If you set “LPF2” or “LPF3,” the setting for the Resonance parameter will be ignored (p. 69).

Cutoff Frequency ★ ①

Selects the frequency at which the filter begins to have an effect on the waveform’s frequency components.

Value: 0–127

With “LPF/LPF2/LPF3” selected for the Filter Type parameter, lower cutoff frequency settings reduce a tone’s upper harmonics for a more rounded, warmer sound. Higher settings make it sound brighter.

If “BPF” is selected, harmonic components will change depending on the TVF Cutoff Frequency setting. This can be useful when creating distinctive sounds.

With “HPF” selected, higher Cutoff Frequency settings will reduce lower harmonics to emphasize just the brighter components of the sound.

With “PKG” selected, the harmonics to be emphasized will vary depending on Cutoff Frequency setting.

TIP

To edit the overall patch while preserving the relative differences in the Cutoff Frequency values set for each tone, set the Cutoff Offset parameter (p. 61).

Resonance ★ ②

Emphasizes the portion of the sound in the region of the cutoff frequency, adding character to the sound. Excessively high settings can produce oscillation, causing the sound to distort.

Value: 0–127

TIP

To edit the overall patch while preserving the relative differences in the Resonance values set for each tone, set the Resonance Offset parameter (p. 62).

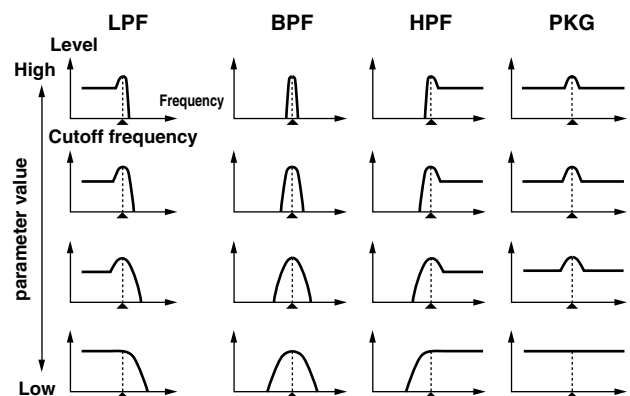

Creating a Patch

Cutoff Key follow ④

Use this parameter if you want the cutoff frequency to change according to the key that is pressed. Relative to the cutoff frequency at the C4 key (center C), positive (+) settings will cause the cutoff frequency to rise for notes higher than C4, and negative (-) settings will cause the cutoff frequency to fall for notes higher than C4. Larger settings will produce greater change.

Value: -200, -190, -180, -170, -160, -150, -140, -130, -120, -110, -100, -90, -80, -70, -60, -50, -40, -30, -20, -10, 0, +10, +20, +30, +40, +50, +60, +70, +80, +90, +100, +110, +120, +130, +140, +150, +160, +170, +180, +190, +200

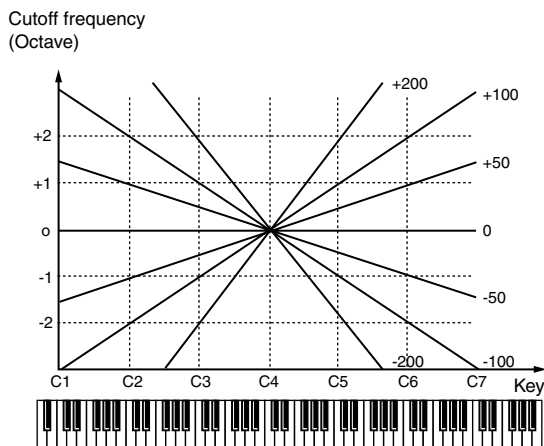

Cutoff V-Curve (Cutoff Frequency Velocity Curve)

Selects one of the following seven curves that determine how keyboard playing dynamics (velocity) influence the cutoff frequency. Set this to "FIXED" if you don't want the Cutoff frequency to be affected by the keyboard velocity.

Value: FIXED, 1-7



Cutoff V-Sens (Cutoff Velocity Sensitivity)

Use this parameter when changing the cutoff frequency to be applied as a result of changes in playing velocity. If you want strongly played notes to raise the cutoff frequency, set this parameter to positive (+) settings. If you want strongly played notes to lower the cutoff frequency, use negative (-) settings.

Value: -63- +63

TIP

To edit the overall patch while preserving the relative differences in the Cutoff Frequency Velocity Sensitivity values set for each tone, set the Velocity Sens Offset parameter (p. 62). However, this setting is shared by the Level V-Sens parameter (p. 71).

Resonance V-Sens (Resonance Velocity Sensitivity)

This allows keyboard velocity to modify the amount of Resonance. If you want strongly played notes to have a greater Resonance effect, set this parameter to positive (+) settings. If you want strongly played notes to have less Resonance, use negative (-) settings.

Value: -63- +63

F-Env V-Curve (TVF Envelope Velocity Curve)

Selects one of the following 7 curves that will determine how keyboard playing dynamics will affect the TVF envelope. Set this to "FIXED" if you don't want the TVF Envelope to be affected by the keyboard velocity.

Value: FIXED, 1-7



F-Env V-Sens (TVF Envelope Velocity Sensitivity)

Specifies how keyboard playing dynamics will affect the depth of the TVF envelope. Positive (+) settings will cause the TVF envelope to have a greater effect for strongly played notes, and negative (-) settings will cause the effect to be less.

Value: -63- +63

F-Env T1 V-Sens (TVF Envelope Time 1 Velocity Sensitivity)

This allows keyboard dynamics to affect the Time 1 of the TVF envelope. If you want Time 1 to be speeded up for strongly played notes, set this parameter to a positive (+) value. If you want it to be slowed down, set this to a negative (-) value.

Value: -63- +63

F-Env T4 V-Sens (TVF Envelope Time 4 Velocity Sensitivity)

The parameter to use when you want key release speed to control the Time 4 value of the TVF envelope. If you want Time 4 to be speeded up for quickly released notes, set this parameter to a positive (+) value. If you want it to be slowed down, set this to a negative (-) value.

Value: -63- +63

TVF ENV

F-Env Depth (TVF Envelope Depth)

Specifies the depth of the TVF envelope. Higher settings will cause the TVF envelope to produce greater change. Negative (-) settings will invert the shape of the envelope.

Value: -63– +63

F-Env Time KF (TVF Envelope Time Key Follow)

Use this setting if you want the TVA envelope times (Time 2–Time 4) to be affected by the keyboard location. Based on the TVF envelope times for the C4 key (center C), positive (+) settings will cause notes higher than C4 to have increasingly shorter times, and negative (-) settings will cause them to have increasingly longer times. Larger settings will produce greater change.

Value: -100, -90, -80, -70, -60, -50, -40, -30, -20, -10, 0, +10, +20, +30, +40, +50, +60, +70, +80, +90, +100

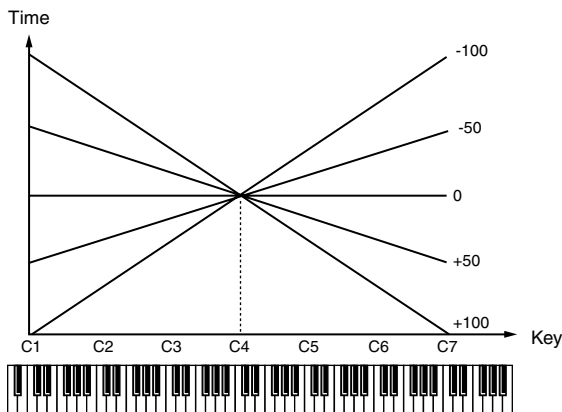

F-Env Time 1–4 (TVF Envelope Time 1–4) ★ ①, ②, ④

Specify the TVF envelope times (Time 1–Time 4). Higher settings will lengthen the time until the next cutoff frequency level is reached. (For example, Time 2 is the time over which Level 1 will change to Level 2.)

Value: 0–127

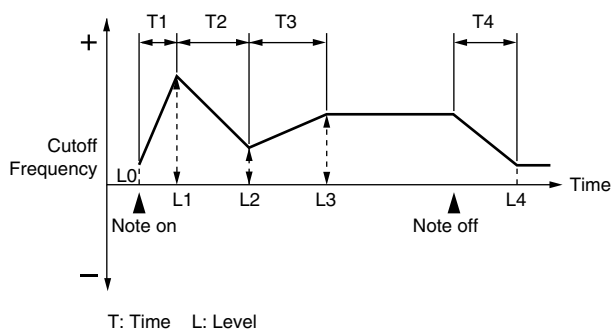

F-Env Level 0–4 (TVF Envelope Level 0–4) ③

Specify the TVF envelope levels (Level 0–Level 4). These settings specify how the cutoff frequency will change at each point, relative to the standard cutoff frequency (the cutoff frequency value specified in the TVF screen).

Value: 0–127

Adjusting the Volume (TVA/TVA Env)

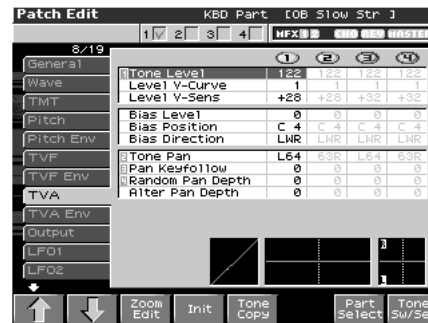

cf.

For details on these settings, refer to “How to Make Patch Settings” (p. 56).

TVA

Tone Level ★ ①

Sets the volume of the tone. This setting is useful primarily for adjusting the volume balance between tones.

Value: 0–127

Level V-Curve (TVA Level Velocity Curve)

You can select from seven curves that determine how keyboard playing strength will affect the volume. If you do not want the volume of the tone to be affected by the force with which you play the key, set this to “FIXED.”

Value: FIXED, 1–7



Level V-Sens (TVA Level Velocity Sensitivity)

Set this when you want the volume of the tone to change depending on the force with which you press the keys. Set this to a positive (+) value to have the changes in tone volume increase the more forcefully the keys are played; to make the tone play more softly as you play harder, set this to a negative (-) value.

Value: -63– +63

TIP

If you wish to make adjustments to the entire patch while maintaining the relative values of TVA Level Velocity Sensitivity among tones, adjust the Velocity Sens Offset parameter (p. 62). However, this setting is shared by the Cutoff V-Sens parameter (p. 70).

Creating a Patch

Bias

Bias causes the volume to be affected by the keyboard position. This is useful for changing volume through keyboard position (pitch) when playing acoustic instruments.

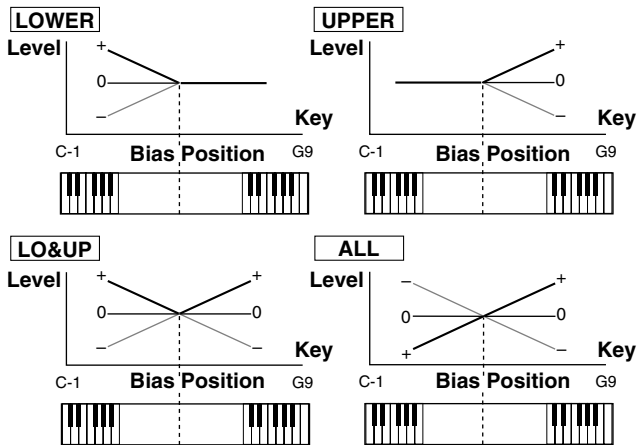

Bias Level

Adjusts the angle of the volume change that will occur in the selected Bias Direction. Larger settings will produce greater change. Negative (-) values will invert the change direction.

Value: -100, -90, -80, -70, -60, -50, -40, -30, -20, -10, 0, +10, +20, +30, +40, +50, +60, +70, +80, +90, +100

Bias Position

Specifies the key relative to which the volume will be modified.

Value: C-1–G9

Bias Direction

Selects the direction in which change will occur starting from the Bias Position.

Value

- LOWER:** The volume will be modified for the keyboard area below the Bias Point.
- UPPER:** The volume will be modified for the keyboard area above the Bias Point.
- LO&UP:** The volume will be modified symmetrically toward the left and right of the Bias Point.
- ALL:** The volume changes linearly with the bias point at the center.

Tone Pan ★ ②

Sets the pan of the tone. "L64" is far left, "0" is center, and "63R" is far right.

Value: L64–0–63R

Pan Key Follow ③

Use this parameter if you want key position to affect panning. Positive (+) settings will cause notes higher than C4 key (center C) to be panned increasingly further toward the right, and negative (-) settings will cause notes higher than C4 key (center C) to be panned toward the left. Larger settings will produce greater change.

Value: -100– +100

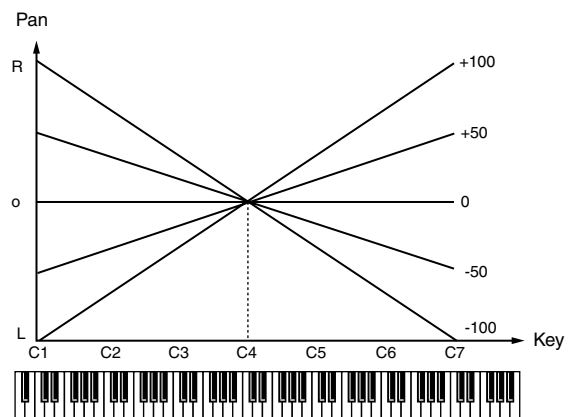

Random Pan Depth ④

Use this parameter when you want the stereo location to change randomly each time you press a key. Higher settings will produce a greater amount of change.

Value: 0–63

Alter Pan Depth (Alternate Pan Depth)

This setting causes panning to be alternated between left and right each time a key is pressed. Higher settings will produce a greater amount of change. "L" or "R" settings will reverse the order in which the pan will alternate between left and right. For example if two tones are set to "L" and "R" respectively, the panning of the two tones will alternate each time they are played.

Value: L63–0–63R

NOTE

When any value from Type "2"–"10" is selected for the Structure parameter in the Pan KF, Rnd Pan Depth, Alter Pan Depth parameter settings, the output of tones 1 and 2 are joined in tone 2, and the output of tones 3 and 4 are joined in tone 4. For this reason, tone 1 will follow the settings of tone 2, and tone 3 will follow the settings of tone 4 (p. 63).

TVA Env

A-Env T1 V-Sens (TVA Envelope Time 1 Velocity Sensitivity)

This allows keyboard dynamics to affect the Time 1 of the TVA envelope. If you want Time 1 to be speeded up for strongly played notes, set this parameter to a positive (+) value. If you want it to be slowed down, set this to a negative (-) value.

Value: -63– +63

A-Env T4 V-Sens (TVA Envelope Time 4 Velocity Sensitivity)

The parameter to use when you want key release speed to control the Time 4 value of the TVA envelope. If you want Time 4 to be speeded up for quickly released notes, set this parameter to a positive (+) value. If you want it to be slowed down, set this to a negative (-) value.

Value: -63– +63

A-Env Time KF (TVA Envelope Time Key Follow)

Use this setting if you want the TVA envelope times (Time 2–Time 4) to be affected by the keyboard location. Based on the TVA envelope times for the C4 key (center C), positive (+) settings will cause notes higher than C4 to have increasingly shorter times, and negative (-) settings will cause them to have increasingly longer times. Larger settings will produce greater change.

Value: -100, -90, -80, -70, -60, -50, -40, -30, -20, -10, 0, +10, +20, +30, +40, +50, +60, +70, +80, +90, +100

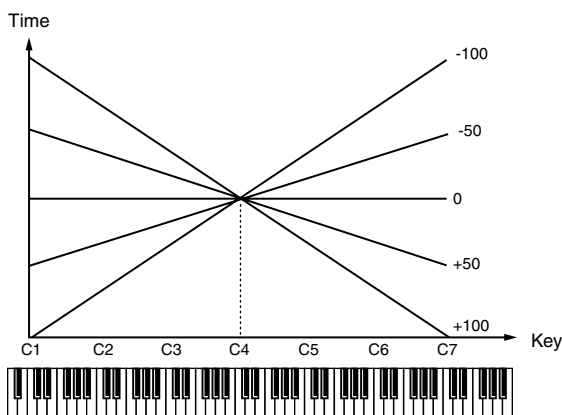

A-Env Time 1–4 (TVA Envelope Time 1–4) ★

①, ②, ④

Specify the TVA envelope times (Time 1– Time 4). Higher settings will lengthen the time until the next volume level is reached. (For example, Time 2 is the time over which Level 1 will change to Level 2.)

Value: 0–127

A-Env Level 1–3 (TVA Envelope Level 1–3) ③

Specify the TVA envelope levels (Level 1–Level 3). These settings specify how the volume will change at each point, relative to the standard volume (the Tone Level value specified in the TVA screen).

Value: 0–127

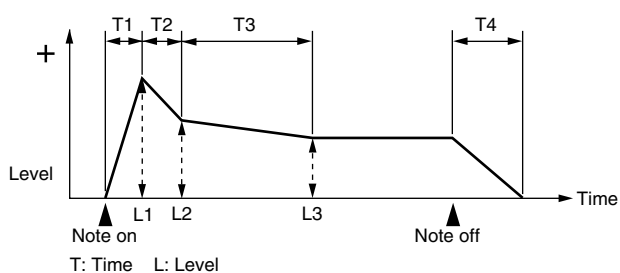

Output

Patch Out Assign

Specifies how the direct sound of each patch will be output.

Value:

AFX: Output in stereo through multi-effects. You can also apply chorus or reverb to the sound that passes through multi-effects.

A, B: Output to the OUTPUT A (MIX) jack or OUTPUT B jack in stereo without passing through multi-effects.

1–4: Output to the INDIVIDUAL 1–4 jacks in mono without passing through multi-effects.

TONE: Outputs according to the settings for each tone.

- * If you've made settings so that sounds are separately routed to the INDIVIDUAL 1 jack and INDIVIDUAL 2 jack, but no plug is actually inserted in the INDIVIDUAL 2 jack, the sounds routed to INDIVIDUAL 1 and INDIVIDUAL 2 will be mixed and output from the INDIVIDUAL 1 jack.
- * If the Mix/Parallel parameter ([MENU]/System/General) is set to "MIX," all sounds are output from the OUTPUT A (MIX) jacks in stereo (p. 230).

Tone Out Assign

Specifies how the direct sound of each tone will be output.

Value:

AFX: Output in stereo through multi-effects. You can also apply chorus or reverb to the sound that passes through multi-effects.

A, B: Output to the OUTPUT A (MIX) jack or OUTPUT B jack in stereo without passing through multi-effects.

1–4: Output to the INDIVIDUAL 1–4 jacks in mono without passing through multi-effects.

- * If the Patch Output Assign is set to anything other than "TONE," these settings will be ignored.
- * When the Structure Type parameter has a setting of Type "2"–"10," the outputs of tones 1 and 2 will be combined with tone 2, and the outputs of tones 3 and 4 will be combined with tone 4. For this reason, tone 1 will follow the settings of tone 2, and tone 3 will follow the settings of tone 4 (p. 63).
- * If you've made settings so that sounds are separately routed to the INDIVIDUAL 1 jack and INDIVIDUAL 2 jack, but no plug is actually inserted in the INDIVIDUAL 2 jack, the sounds routed to INDIVIDUAL 1 and INDIVIDUAL 2 will be mixed and output from the INDIVIDUAL 1 jack.
- * If the Mix/Parallel parameter is set to "MIX," all sounds are output from the OUTPUT A (MIX) jacks in stereo (p. 230).
- * If you've set Tone Out Assign to "AFX," set the AFX Output Assign parameter (p. 208) to specify the output destination of the sound that has passed through the multi-effects.
- * Sounds are output to chorus and reverb in mono at all times.
- * The output destination of the signal after passing through the chorus is set with the Chorus Output Select (p. 209) and the Chorus Output Assign (p. 209).
- * The output destination of the signal after passing through the reverb is set with the Reverb Output Assign (p. 209).

Creating a Patch

Tone Out Level

Set the level of the signal that is sent to the output destination specified by Tone Output Assign.

Value: 0–127

Tone Chorus Send (Send Level (Output=MFX))

①

Specifies the level of the signal sent to the chorus for each tone if the tone is sent through MFX.

Value: 0–127

Tone Reverb Send (Send Level (Output=MFX))

②

Specifies the level of the signal sent to the reverb for each tone if the tone is sent through MFX.

Value: 0–127

Tone Chorus Send (Send Level (Output=non MFX))

③

Sets the level of the signal sent to chorus for each tone if the tone is not sent through MFX.

Value: 0–127

Tone Reverb Send (Send Level (Output=non MFX))

④

Sets the level of the signal sent to reverb for each tone if the tone is not sent through MFX.

Value: 0–127

Modulating Sounds (LFO)

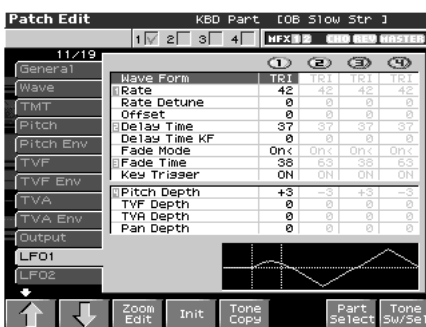

cf.

For details on these settings, refer to “How to Make Patch Settings” (p. 56).

MEMO

An LFO (Low Frequency Oscillator) causes change over a cycle in a sound. Each tone has two LFOs (LFO1/LFO2), and these can be used to cyclically change the pitch, cutoff frequency and volume to create modulation-type effects such as vibrato, wah and tremolo. Both LFOs have the same parameters so only one explanation is needed.

LFO 1/2

Waveform (LFO1/LFO2 Waveform)

Selects the waveform of the LFO.

Value

SIN: Sine wave

TRI: Triangle wave

SAW-U: Sawtooth wave

SAW-D: Sawtooth wave (negative polarity)

SQR: Square wave

RND: Random wave

BND-U: Once the attack of the waveform output by the LFO is allowed to develop in standard fashion, the waveform then continues without further change.

BND-D: Once the decay of the waveform output by the LFO is allowed to develop in standard fashion, the waveform then continues without further change.

TRP: Trapezoidal wave

S&H: Sample & Hold wave (one time per cycle, LFO value is changed)

CHAOS: Chaos wave

VSIN: Modified sine wave. The amplitude of a sine wave is randomly varied once each cycle.

STEP: A waveform generated by the data specified by LFO Step 1–16. This produces stepped change with a fixed pattern similar to a step modulator.

NOTE

If you set this to “BND-U” or “BND-D,” you must turn the Key Trigger parameter to “ON.” If this is “OFF,” it will have no effect.

LFO Rate (LFO1/LFO2 Rate) ★ ①

Adjusts the modulation rate, or speed, of the LFO.

Value: 0–127, Note

LFO Rate sets the beat length for the synchronized tempo is synchronized with the tempo set in a sequencer.

(Example)

For a tempo of 120 (120 quarter notes occur in 1 minute (60 seconds))

Setting	LFO Rate
♩ (half note)	1 second (60 / 60 = 1 (seconds))
♩ (quarter note)	0.5 seconds (60 / 120 = 0.5 (seconds))
♩ (eighth note)	0.25 seconds (60 / 240 = 0.25 (seconds))

NOTE

This setting will be ignored if the Waveform parameter is set to “CHAOS.”

Rate Detune (LFO1/LFO2 Rate Detune)

LFO Rate Detune makes subtle changes in the LFO cycle rate (Rate parameter) each time a key is pressed. Higher settings will cause greater change. This parameter is invalid when Rate is set to "note."

Value: 0-127

Offset (LFO1/LFO2 Offset)

Raises or lowers the LFO waveform relative to the central value (pitch or cutoff frequency). Positive (+) settings will move the waveform so that modulation will occur from the central value upward. Negative (-) settings will move the waveform so that modulation will occur from the central value downward.

Value: -100, -50, 0, +50, +100

Delay Time (LFO1/LFO2 Delay Time) ②

Delay Time (LFO Delay Time) specifies the time elapsed before the LFO effect is applied (the effect continues) after the key is pressed (or released).

Value: 0-127

cf.

After referring to "How to Apply the LFO" (p. 76), change the setting until the desired effect is achieved.

TIP

When using violin, wind, or certain other instrument sounds in a performance, rather than having vibrato added immediately after the sounds are played, it can be effective to add the vibrato after the note is drawn out somewhat. If you set the Delay Time in conjunction with the Pitch Depth parameter and Rate parameter, the vibrato will be applied automatically following a certain interval after the key is pressed. This effect is called **Delay Vibrato**.

Delay Time KF (LFO1/LFO2 Delay Time Key Follow)

Adjusts the value for the Delay Time parameter depending on the key position, relative to the C4 key (center C). To decrease the time that elapses before the LFO effect is applied (the effect is continuous) with each higher key that is pressed in the upper registers, select a positive value; to increase the elapsed time, select a negative value. Larger settings will produce greater change. If you do not want the elapsed time before the LFO effect is applied (the effect is continuous) to change according to the key pressed, set this to "0."

Value: -100, -90, -80, -70, -60, -50, -40, -30, -20, -10, 0, +10, +20, +30, +40, +50, +60, +70, +80, +90, +100

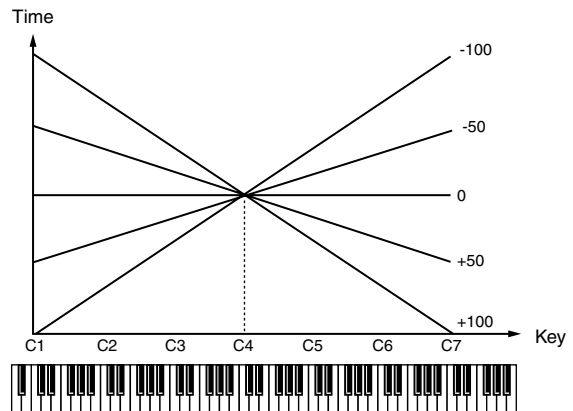

Fade Mode (LFO1/LFO2 Fade Mode)

Specifies how the LFO will be applied.

Value: ON <, ON >, OFF <, OFF >

cf.

After referring to "How to Apply the LFO" (p. 76), change the setting until the desired effect is achieved.

Fade Time (LFO1/LFO2 Fade Time) ③

Specifies the time over which the LFO amplitude will reach the maximum (minimum).

Value: 0-127

cf.

After referring to "How to Apply the LFO" (p. 76), change the setting until the desired effect is achieved.

Key Trigger (LFO1/LFO2 Key Trigger)

This specifies whether the LFO cycle will be synchronized to begin when the key is pressed (ON) or not (OFF).

Value: OFF, ON

Pitch Depth (LFO1/LFO2 Pitch Depth) ★ ④

Specifies how deeply the LFO will affect pitch.

Value: -63- +63

TVF Depth (LFO1/LFO2 TVF Depth) ★

Specifies how deeply the LFO will affect the cutoff frequency.

Value: -63- +63

TVA Depth (LFO1/LFO2 TVA Depth) ★

Specifies how deeply the LFO will affect the volume.

Value: -63- +63

Creating a Patch

Pan Depth (LFO1/LFO2 Pan Depth) ★

Specifies how deeply the LFO will affect the pan.

Value: -63– +63

TIP

Positive (+) and negative (-) settings for the Depth parameter result in differing kinds of change in pitch and volume. For example, if you set the Depth parameter to a positive (+) value for one tone, and set another tone to the same numerical value, but make it negative (-), the modulation phase for the two tones will be the reverse of each other. This allows you to shift back and forth between two different tones, or combine it with the Pan setting to cyclically change the location of the sound image.

NOTE

When the Structure parameter is set to any value from “2” through “10,” the output of tones 1 and 2 will be combined into tone 2, and the output of tones 3 and 4 will be combined into tone 4. This applies to the Pan Depth parameter settings. For this reason, tone 1 will follow the settings of tone 2, and tone 3 will follow the settings of tone 4 (p. 63).

Step LFO

LFO Step Type (LFO Step Type)

When generating an LFO waveform from the data specified in LFO Step1–16, specify whether the level will change abruptly at each step or will be connected linearly.

Value: TYPE1 (stair-step change), TYPE2 (linear change)

Step 1–16 (LFO Step 1–16)

Specifies the data for the Step LFO. If the LFO Pitch Depth is +63, each +1 unit of the step data corresponds to a pitch of +50 cents.

Value: -36– +36

How to Apply the LFO

● Apply the LFO gradually after the key is pressed

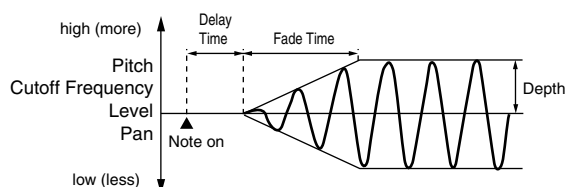

Fade Mode: ON <

Delay Time: The time from when the keyboard is played until the LFO begins to be applied.

Fade Time: The time over which the LFO amplitude will reach the maximum after the Delay Time has elapsed.

● Apply the LFO immediately when the key is pressed, and then gradually begin to decrease the effect

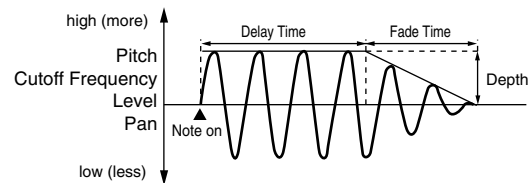

Fade Mode: ON >

Delay Time: The time that the LFO will continue after the keyboard is played.

Fade Time: The time over which the LFO amplitude will reach the minimum after the Delay Time has elapsed.

● Apply the LFO gradually after the key is released

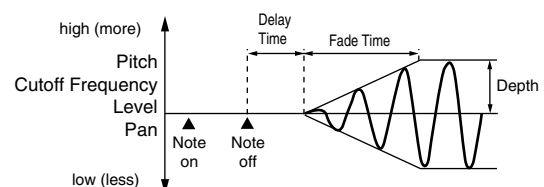

Fade Mode: OFF <

Delay Time: The time from when the keyboard is released until the LFO begins to be applied.

Fade Time: The time over which the LFO amplitude will reach the maximum after the Delay Time has elapsed.

● Apply the LFO from when the key is pressed until it is released, and gradually begin to decrease the effect when the key is released

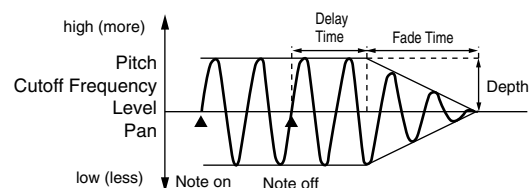

Fade Mode: OFF >

Delay Time: The time that the LFO will continue after the keyboard is released.

Fade Time: The time over which the LFO amplitude will reach the minimum after the Delay Time has elapsed.

Apply Portamento or Legato to the Sound (Solo/Porta)

Solo/Portamento



cf. →

For details on these settings, refer to “How to Make Patch Settings” (p. 56).

Mono/Poly

Specifies whether the patch will play polyphonically (POLY) or monophonically (MONO). The “MONO” setting is effective when playing a solo instrument patch such as sax or flute.

Value

MONO: Only the last-played note will sound.

POLY: Two or more notes can be played simultaneously.

Legato Switch (Legato Switch)

Legato Switch is valid when the Mono/Poly parameter is set to “MONO.” This setting specifies whether the Legato Switch will be used (ON) or not (OFF).

With the Legato Switch parameter “ON,” pressing a key while continuing to press a previous key causes the note to change pitch to the pitch of the most recently pressed key, sounding all the while. This creates a smooth transition between notes, which is effective when you wish to simulate the hammering-on and pulling-off techniques used by a guitarist.

Value: OFF, ON

Legato Retrigger (Legato Retrigger Switch)

The Legato Retrigger is valid when the Mono/Poly parameter is set to “MONO” and the Legato Switch parameter is set to “ON.” The setting determines whether sounds are replayed (ON) or not (OFF) when performing legato. Normally you will leave this parameter “ON.” When “OFF,” when one key is held down and another key is then pressed, only the pitch changes, without the attack of the latter key being played. Set this to “OFF” when performing wind and string phrases or when using modulation with the mono synth keyboard sound.

Value: OFF, ON

Let’s say you have the Legato Switch set to “ON,” and the Legato Retrigger set to “OFF.” When you try to sound a legato (by pressing a higher key while a lower key is held down), the pitch may sometimes not be able to rise all the way to the intended pitch (stopping instead at an intermediate pitch). This can occur because the limit of pitch rise, as determined at the wave level, has been exceeded. Additionally, if differing upper pitch limits are used for the waves of a Patch that uses multiple tones, it may stop being heard in MONO. When making large pitch changes, set the Legato Retrigger to “ON.”

Portamento Switch

Specifies whether the portamento effect will be applied (ON) or not (OFF).

Value: OFF, ON

Portamento

Portamento is an effect which smoothly changes the pitch from the first-played key to the next-played key. By applying portamento when the Mono/Poly parameter is “MONO,” you can simulate slide performance techniques on a violin or similar instrument.

Portamento Mode

Specifies the performance conditions for which portamento will be applied.

Value

NORMAL: Portamento will always be applied.

LEGATO: Portamento will be applied only when you play legato (i.e., when you press the next key before releasing the previous key).

Portamento Type

Specifies the type of portamento effect.

Value

RATE: The time it takes will depend on the distance between the two pitches.

TIME: The time it takes will be constant, regardless of how far apart in pitch the notes are.

Creating a Patch

Portamento Start

When another key is pressed during a pitch change produced by portamento, a new pitch change will begin. This setting specifies the pitch at which the change will begin.

Value

PITCH: Starts a new portamento when another key is pressed while the pitch is changing.

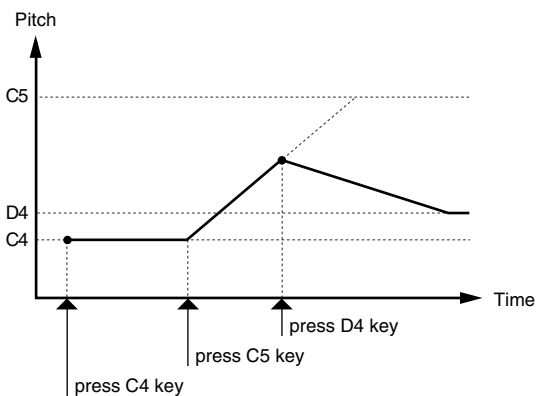

NOTE: Portamento will begin anew from the pitch where the current change would end.

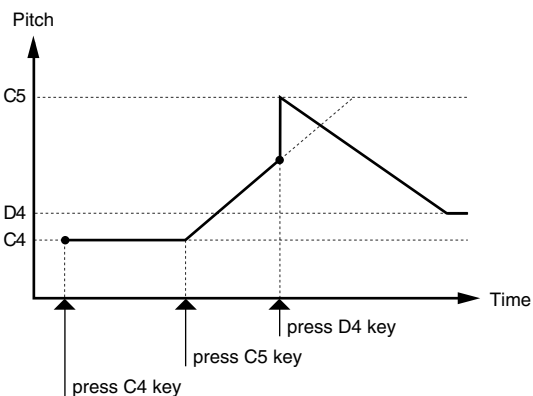

Portamento Time

When portamento is used, this specifies the time over which the pitch will change. Higher settings will cause the pitch change to the next note to take more time.

Value: 0-127

Miscellaneous Settings (Misc)



Tone Delay Mode

Selects the type of tone delay.

Value

NORM: The tone begins to play after the time specified in the Delay Time parameter has elapsed.

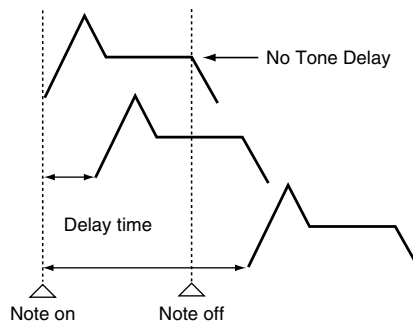

HOLD: Although the tone begins to play after the time specified in the Delay Time parameter has elapsed, if the key is released before the time specified in the Delay Time parameter has elapsed, the tone is not played.

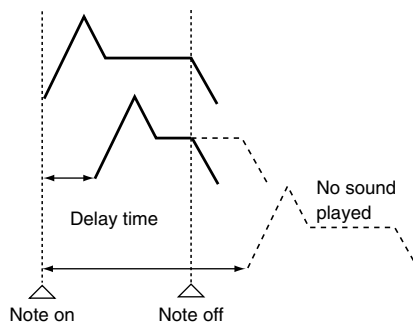

OFF-N: Rather than being played while the key is pressed, the tone begins to play once the period of time specified in the Delay Time parameter has elapsed after release of the key. This is effective in situations such as when simulating noises from guitars and other instruments.

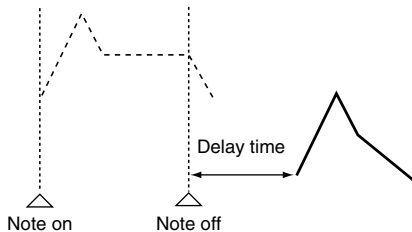

OFF-D: Rather than being played while the key is pressed, the tone begins to play once the period of time specified in the Delay Time parameter has elapsed after release of the key. Here, however, changes in the TVA Envelope begin while the key is pressed, which in many cases means that only the sound from the release portion of the envelope is heard.

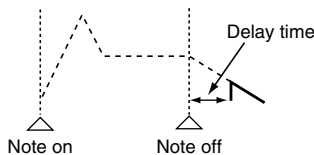

NOTE
If you have selected a waveform that is a decay-type sound (i.e., a sound that fades away naturally even if the key is not released), selecting "OFF-N" or "OFF-D" may result in no sound being heard.

Tone Delay

This produces a time delay between the moment a key is pressed (or released), and the moment the tone actually begins to sound. You can also make settings that shift the timing at which each tone is sounded. This differs from the Delay in the internal effects, in that by changing the sound qualities of the delayed tones and changing the pitch for each tone, you can also perform arpeggio-like passages just by pressing one key. You can also synchronize the tone delay time to the tempo of the sequencer.

NOTE

If you are not going to use Tone Delay, set the Delay Mode parameter to "NORM" and Delay Time parameter to "0."

- If the Structure parameters set in the range of "2"–"10," the output of tones 1 and 2 will be combined into tone 2, and the output of tones 3 and 4 will be combined into tone 4. For this reason, tone 1 will follow the settings of tone 2, and tone 3 will follow the settings of tone 4 (p. 63).

Tone Delay Time

Specifies the time from when the key is pressed (or if the Delay Mode parameter is set to "OFF-N" or "OFF-D," the time from when the key is released) until when the tone will sound.

Value: 0–127, Note

Tone Delay Time specifies the beat length for the synchronized tempo when the tempo that specifies the elapsed time until the tone is sounded (Patch Tempo) is synchronized with the tempo set in a sequencer.

(Example)

For a tempo of 120 (120 quarter notes occur in 1 minute (60 seconds))

Setting	Delay time
♩ (half note)	1 second (60 / 60 = 1 (second))
♪ (quarter note)	0.5 seconds (60 / 120 = 0.5 (seconds))
♫ (eighth note)	0.25 seconds (60 / 240 = 0.25 (seconds))

Tone Env Mode (Tone Envelope Mode)

When a loop waveform (p. 59) is selected, the sound will normally continue as long as the key is pressed. If you want the sound to decay naturally even if the key remains pressed, set this to "NO SUS."

Range: NO SUS, SUST

NOTE

If a one-shot type Wave (p. 58) is selected, it will not sustain even if this parameter is set to "SUST."

Tone Rx Bender (Tone Receive Pitch Bend Switch)

For each tone, specify whether MIDI Pitch Bend messages will be received (ON), or not (OFF).

Value: OFF, ON

Tone Rx Expression (Tone Receive Expression Switch)

For each tone, specify whether MIDI Expression messages will be received (ON), or not (OFF).

Value: OFF, ON

Tone Rx Hold-1 (Tone Receive Hold Switch)

For each tone, specify whether MIDI Hold-1 messages will be received (ON), or not (OFF).

Value: OFF, ON

NOTE

If "NO SUS" is selected for Env Mode parameter, this setting will have no effect.

Creating a Patch

Tone Rx Pan Mode

For each tone, specify how pan messages will be received.

Value

- CONT:** Whenever Pan messages are received, the stereo position of the tone will be changed.
- K-ON:** The pan of the tone will be changed only when the next note is played. If a pan message is received while a note is sounding, the panning will not change until the next key is pressed.

NOTE

The channels cannot be set so as not to receive Pan messages.

Tone Redamper Sw (Tone Redamper Switch)

You can specify, on an individual tone basis, whether or not the sound will be held when a Hold 1 message is received after a key is released, but before the sound has decayed to silence. If you want to sustain the sound, set this "ON." When using this function, also set the Rx Hold-1 parameter "ON." This function is effective for piano sounds.

Value: OFF, ON

Matrix Control Settings (Ctrl1-4)



cf.

For details on these settings, refer to "How to Make Patch Settings" (p. 56).

Matrix Control

Ordinarily, if you wanted to change tone parameters using an external MIDI device, you would need to send System Exclusive messages—MIDI messages designed exclusively for the Fantom-X. However, System Exclusive messages tend to be complicated, and the amount of data that needs to be transmitted can get quite large.

For that reason, a number of the more typical of the Fantom-X's tone parameters have been designed so they accept the use of Control Change (or other) MIDI messages for the purpose of making changes in their values. This provides you with a variety of means of changing the way patches are played. For example, you can use the Pitch Bend lever to change the LFO cycle rate, or use the keyboard's touch to open and close a filter. The function which allows you use MIDI messages to make these changes in realtime to the tone parameters is called the **Matrix Control**. Up to four Matrix Controls can be used in a single patch.

To use the Matrix Control, specify which MIDI message (Source parameter) will be used to control which parameter (Destination parameter), and how greatly (Sns parameter), and the tone to which the effect is applied (Tone parameter).

Matrix Control 1–4 Source

Sets the MIDI message used to change the tone parameter with the Matrix Control.

Value

OFF: Matrix control will not be used.
CC01–31, 33–95: Controller numbers 1–31, 33–95



For more information about Control Change messages, please refer to “MIDI Implementation” (p. 298).

PITCH BEND: Pitch Bend
AFTERTOUC: Aftertouch
SYS CTRL1–SYS CTRL4: MIDI messages used as common matrix controls.
VELOCITY: Velocity (pressure you press a key with)
KEY FOLLOW: Key follow (keyboard position with C4 as 0)
TEMPO: The specified tempo (sequencer tempo) or the tempo of an external MIDI sequencer.
LFO1: LFO 1
LFO2: LFO 2
PITCH ENV: Pitch envelope
TVF ENV: TVF envelope
TVA ENV: TVA envelope



Velocity and Key follow correspond to Note messages.



Although there are no MIDI messages for LFO 1 through TVA Envelope, they can be used as Matrix Control. In this case, you can change the tone settings in realtime by playing patches.

- If you want to use common controllers for the entire Fantom-X, select “SYS CTRL1”–“SYS CTRL4.” MIDI messages used as System Control 1–4 are set with the System Ctrl 1–4 Source parameters (p. 233).



There are parameters that determine whether or not Pitch Bend, Controller Number 11 (Expression) and Controller Number 64 (Hold 1) are received (p. 79). When these settings are “ON,” and the MIDI messages are received, then when any change is made in the settings of the desired parameter, the Pitch Bend, Expression, and Hold 1 settings also change simultaneously. If you want to change the targeted parameters only, then set these to “OFF.”

- There are parameters that let you specify whether specific MIDI messages will be received for each channel in a performance (p. 112). When a patch with Matrix Control settings is assigned to a part, confirm that any MIDI messages used for the Matrix Control will be received. If the Fantom-X is set up such that reception of MIDI messages is disabled, then the Matrix Control will not function.

CTRL Destination 1–4 (Matrix Control Destination 1–4)

Matrix Control Destination selects the tone parameter that is to be controlled when using the Matrix Control. The following parameters can be controlled. When not controlling parameters with the Matrix Control, set this to “OFF.” Up to four parameters can be specified for each Matrix Control, and controlled simultaneously.



In this manual, Parameters that can be controlled using the Matrix Control are marked with a “★.”

● Opening and Closing the Filter

CUTOFF: Changes the cutoff frequency.
RESONANCE: Emphasizes the overtones in the region of the cutoff frequency, adding character to the sound.

● Changing the Volume, Pan, and Pitch

LEVEL: Changes the volume level.
PAN: Changes the pan.
PITCH: Changes the pitch.

● Changing How the Effects Are Applied

OUTPUT LEVEL: Changes the volume of output levels.
CHORUS SEND: Changes the amount of chorus.
REVERB SEND: Changes the amount of reverb.

● Applying LFO to Modulate Sounds

LFO1/LFO2 PCH DEPTH: Changes the vibrato depth.
LFO1/LFO2 TVF DEPTH: Changes the wah depth.
LFO1/LFO2 TVA DEPTH: Changes the tremolo depth.
LFO1/LFO2 PAN DEPTH: Changes the effect that the LFO will have on pan.
LFO1/LFO2 RATE: Changes the LFO cycle rate.
 Changes the speed of the LFO cycles.

* The speed will not change if LFO Rate is set to “note.”

● Changing the Pitch Envelope

PIT ENV A-TIME: Changes the Env Time 1 parameter of the pitch envelope.
PIT ENV D-TIME: Changes the Env Time 2 and Env Time 3 parameters of the pitch envelope.
PIT ENV R-TIME: Changes the Env Time 4 parameter of the pitch envelope.

● Changing the TVF Envelope

TVF ENV A-TIME: Changes the Env Time 1 parameter of the TVF envelope.
TVF ENV D-TIME: Changes the Env Time 2 and Env Time 3 parameters of the TVF envelope.
TVF ENV R-TIME: Changes the Env Time 4 parameter of the TVF envelope.

● Changing the TVF Envelope

TVA ENV A-TIME: Changes the Env Time 1 parameter of the TVA envelope.

TVA ENV D-TIME: Changes the Env Time 2 and Env Time 3 parameters of the TVA envelope.

TVA ENV R-TIME: Changes the Env Time 4 parameter of the TVA envelope.

● Splitting Tones That Are Played

TMT



If the Matrix Control is used to split tones, set the TMT Vel Control parameter to “OFF,” and the TMT Control Switch parameter to “ON” (p. 66, p. 66).

- If the Matrix Control is used to split tones, we recommend setting the Matrix Control Sens to “+63.” Selecting a lower value may prevent switching of the tones. Furthermore, if you want to reverse the effect, set the value to “-63.”
- If you want to use matrix control to switch smoothly between tones, use the Velo Fade Lower and Velo Fade Upper parameters (p. 66). The higher the values set, the smoother the switch is between the tones.

● Changing the Depth of Frequency Modulation for FXM

FXM DEPTH

● Controlling the amount of realtime stretch/shrink

TIME

NOTE

This will have no effect if Realtime Time Stretch (p. 63) is not selected. If matrix control sensitivity is set to “+” the stretch/shrink time will become shorter, and if set to “-” the time will become longer.

● Changing Specific Multi-Effects Parameters

MFx CTRL1-4: Change the parameter that was specified by MFx Control 1-4 Assign parameter.

NOTE

If you have not made the necessary settings for using the multi-effect, the multi-effect will not be applied even if you attempt to control it as a Matrix Control destination.

● If you're not using Matrix Control

OFF: Matrix Control will not be used.

CTRL Sens 1-4 (Matrix Control Sens 1-4)

Sets the amount of the Matrix Control's effect that is applied. If you wish to modify the selected parameter in a positive (+) direction – i.e., a higher value, toward the right, or faster etc. – from its current setting, select a positive (+) value. If you wish to modify the selected parameter in a negative (-) direction – i.e., a lower value, toward the left, or slower etc. – from its current setting, select a negative (-) value. For either positive or negative settings, greater absolute values will allow greater amounts of change. Set this to “0” if you don't want to apply the effect.

Value: -63- +63

CTRL Tone 1-4 (Tone Control Switch 1-4)

Matrix Control Tone selects the tone to which the effect is applied when using the Matrix Control.

Value

OFF: The effect will not be applied.

ON: The effect will be applied.

REVS: The effect will be applied in reverse.

Setting Effects for a Patch (Effects/MFX/MFX Control/Chorus/Reverb)



For details regarding effect settings, refer to the pages shown below.

- “Making Effect Settings” (p. 206)
- “Making Multi-Effects Settings (MFX1-3)” (p. 213)
- “Making Chorus Settings (Chorus)” (p. 215)
- “Making Reverb Settings (Reverb)” (p. 216)

Creating a Rhythm Set

With the Fantom-X, you have total control over a wide variety of settings. Each item that can be set is known as a **parameter**. When you change the values of parameters, you are doing what is referred to as **Editing**. This chapter explains the procedures used in creating rhythm sets, and the functions of the rhythm set parameters.

How to make Rhythm Set settings

Start with an existing rhythm set and edit it to create a new rhythm set. Rhythm sets are created from a collection of multiple rhythm tones (percussion instruments). You can change the assignments of the rhythm tones for each key with rhythm set edit.

The rhythm tone assigned to each key consists of up to four waves. Rhythm tones and waves are related in the same way that patches and tones are related.

1. Press **[PATCH/RHYTHM]** to access the Patch Play screen, and select the part (keyboard part or pad part) and rhythm set whose settings you want to edit (p. 52).

NOTE

You cannot edit the rhythm sets in the GM group.

TIP

If you want to create a rhythm set from scratch (rather than starting from an existing rhythm set), execute the **Initialize** operation (p. 84).

2. Press **[PATCH EDIT]**.

The Rhythm Edit screen appears.

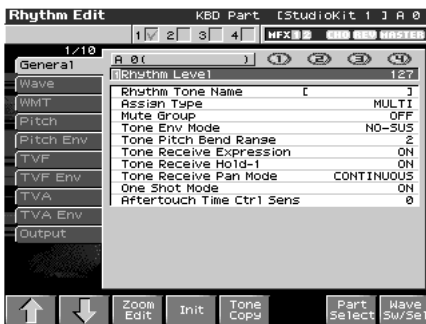

3. The parameters are organized into several editing groups. Press **[F1 (↑)]** or **[F2 (↓)]** to select the tab for the editing group that contains the parameter you wish to edit.

cf.

For details on how the parameters are grouped, refer to "Rhythm Set Parameter" (p. 259).

4. Use **▲** or **▼** to move the cursor to the parameter you wish to modify.

5. Press **[F8 (Wave Sw/Sel)]** to select the wave that you want to edit.

The Wave Sw/Select window will appear.



Press any one of the **[F5 (Wave Select1)]**–**[F8 (Wave Select4)]** buttons to select the wave that you want to edit.

- **Simultaneously editing the same parameter of multiple waves**

To select the tones you want to edit at the same time, simultaneously press two or more of the **[F5 (Wave Select1)]**–**[F8 (Wave Select4)]** buttons, making them light red.

- **To switch a wave on/off**

Press a **[F1 (Wave Sw1)]**–**[F4 (Wave Sw4)]** button to switch the corresponding wave on/off.

* You can also select the tone by pressing **◀** or **▶**.

6. When you have made your selection, press **[EXIT]**.

7. Turn the **VALUE** dial, or Press **[INC]/[DEC]** to set a value.

- **To change the part that you want to edit**

Press **[F7 (Part Select)]**.

8. Repeat steps 5–7 to set each parameter you want to edit.

9. If you wish to save the changes you've made, press **[WRITE]** to perform the Save operation (p. 86). If you do not wish to save changes, press **[EXIT]** to return to the Patch Play screen.

If you return to the Patch Play screen without saving, an "*" will be displayed at the left of the rhythm set number, indicating that the rhythm set settings have been edited.

NOTE

If you turn off the power or select a different sound while the display indicates "*", your edited rhythm set will be lost.

Creating a Rhythm Set

Editing in a Graphic Display (Zoom Edit)

You can edit while viewing a graphic display of the most frequently used important parameters.

Zoom Edit lets you edit the following parameters.

Parameter	page
Pitch Envelope	p. 91
TVF	p. 92
TVF Envelope	p. 93
TVA Envelope	p. 94

1. Press [PATCH/RHYTHM] to access the Patch Play screen, and select the part (keyboard part or pad part) and patch that you want to edit.
2. Press [PATCH EDIT], and then press [F3 (Zoom Edit)].
The Zoom Edit screen will appear.



3. The parameters are organized into several edit groups. Press [F1]–[F4] to select the tab for the parameters that you want to edit.
 - To select a Wave for editing or switch a Wave on/off
Press [F8 (Wave Sw/Sel)].
 - To switch to a different part for editing
Press [F7 (Part Select)].
4. Use [CURSOR] to move the cursor to the parameter that you want to edit.
You can use the realtime control knob to set the value.
5. Turn the VALUE dial or use [INC][DEC] to modify the value.
6. When you have finished editing, press [EXIT].

Initializing Rhythm Set Settings (Init)

“Initialize” means to return the settings of the currently selected sound to a standard set of values or to the factory settings.

NOTE

The Initialize operation will affect only the currently selected sound; the sounds that are stored in user memory will not be affected. If you wish to restore all of the Fantom’s settings to their factory values, perform a Factory Reset (p. 235).

1. Press [PATCH/RHYTHM] to access the Patch Play screen, and select the part (keyboard part or pad part) and rhythm set that you want to initialize (p. 52).
2. Hold down [SHIFT] and press [F1 (Init)].
A message will ask you for confirmation.
3. Press [F8 (Exec)].
The initialization will be carried out, and you’ll be returned to the previous screen.
To cancel, press [F7 (Cancel)].

Initializing only a specific key

Here’s how to initialize only a specific key of a Rhythm Set.

1. Press [PATCH/RHYTHM] to access the Patch Play screen, and select the part (keyboard part or pad part) and rhythm set that you want to initialize (p. 52).
2. Press [PATCH EDIT].
Press keys to specify the key (A0–C8) that is to be initialized.
3. Press [F4 (Init)].
Select the type of initialization.
 - ALL: All keys of the rhythm set will be initialized. (This is the same as the rhythm set initialize procedure described above.)
 - KEY: One key will be initialized.
4. Press [F8 (Select)].
A message will ask for confirmation.
5. Press [F8 (Exec)].
The initialization will be carried out, and you’ll be returned to the previous screen.
To cancel, press [F7 (Cancel)].

Copying Rhythm Tone Settings (Copy)

This operation copies the settings of any desired rhythm set to the currently selected rhythm set. You can use this feature to make the editing process faster and easier.

Basic Procedure for Rhythm Tone Copy

1. Press [PATCH/RHYTHM] to access the Patch Play screen, and select the part (keyboard part or pad part) that you want to edit and the copy-destination Rhythm set (p. 52).
2. Press [PATCH EDIT].

3. Press [F5 (Tone Copy)].

The Rhythm Copy window appears.



4. Using [CURSOR] to move the cursor, select the “Source (copy-source)” bank and number, and the rhythm tone.

5. Turn the VALUE dial or use [INC][DEC] to make the setting.

6. Using [CURSOR] to move the cursor, select the “Destination (copy-destination)” rhythm tone number.

7. Turn the VALUE dial or use [INC][DEC] to make the setting.

8. Press [F8 (Exec)].

A message will ask for confirmation.

9. Press [F8 (Exec)] to return to the Rhythm Edit screen.

* To cancel, press [F7 (Cancel)].

The Compare Function

For the Rhythm Tone Copy operations, you can use the Compare function.

If you want to play the copy-source patch, press [F6 (Compare)] to light it into red. Now you can play the copy-source rhythm set from the keyboard or pads.



NOTE

The rhythm set auditioned using the Compare function may sound slightly different than when it is played normally.

Cautions When Selecting a Waveform

The sounds of the Fantom-X are based on complex PCM waveforms, and if you attempt to make settings that are contrary to the type of the original waveform, the results will not be as you expect.

The internal waveforms of the Fantom-X fall into the following two groups.

One-shot: These waveforms contain sounds that have short decays. A one-shot waveform records the initial rise and fall of the sound. Some of the Fantom-X’s one-shot waveforms are sounds that are complete in

themselves, such as percussive instrument sounds. The Fantom-X also contains many other one-shot waveforms that are elements of other sounds. These include attack components such as piano-hammer sounds and guitar fret noises.

Looped:

These waveforms include sounds with long decays as well as sustained sounds. Loop waveforms repeatedly play back (loop) the portion of the waveform after the sound has reached a relatively steady state. The Fantom-X’s looped waveforms also include components of other sounds, such as piano-string resonant vibrations and the hollow sounds of brass instruments.

Cautions When Using a One-shot Waveform

It is not possible to use the envelope to modify a one-shot waveform to create a decay that is longer than the original waveform, or to turn it into a sustaining sound. If you were to program such an envelope, you would be attempting to shape a portion of the sound that simply doesn’t exist, and the envelope would have no effect.

Cautions When Using a Loop Waveform

With many acoustic instruments such as piano and sax, extreme timbral changes occur during the first few moments of each note. This initial attack is what defines much of the instrument’s character. For such waveforms, it is best to use the complex tonal changes of the attack portion of the waveform just as they are, and to use the envelope only to modify the decay portion. If you attempt to use the envelope to modify the attack portion as well, the characteristics of the original waveform may prevent you from getting the sound that you intend.

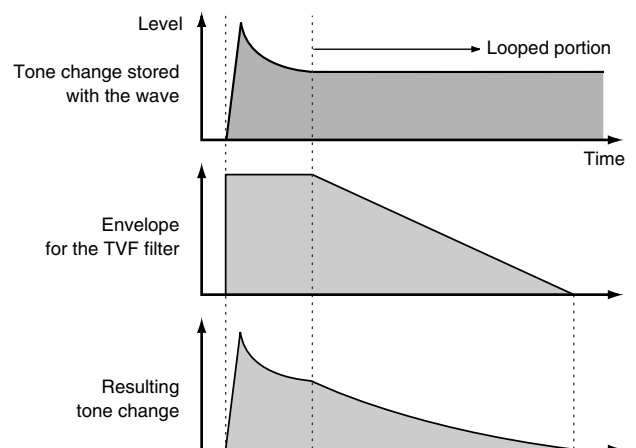

Creating a Rhythm Set

Saving Rhythm Sets You've Created (Write)

Changes you make to sound settings are temporary, and will be lost if you turn off the power or select another sound. If you want to keep the modified sound, you must save it in the internal user memory or memory card.

When you edit the patch settings, an "*" will appear in the Patch Play screen.

NOTE

When you perform the save procedure, the data that previously occupied the save destination will be lost.

1. Make sure that the Rhythm Set you wish to save is selected.

2. Press [WRITE].

The WRITE Menu screen appears.



3. Press [F2 (Patch/Rhythm)].

* Press ▲ or ▼ to select "Rhythm Edit," and then press [ENTER].

The Rhythm Set Name screen appears.



4. Assign a name to the rhythm set.

cf. →

For details on assigning names, refer to "Assigning a Name" (p. 36)

5. When you have finished inputting the name, press [F8 (Write)].

A screen will appear, allowing you to select the write-destination rhythm set.

6. Turn the VALUE dial or use [INC][DEC] and [F2 (↑)] [F3 (↓)] to select the write destination and rhythm set number.

The write destination can be either the Fantom-X's internal user area (User), or a memory card (Card).

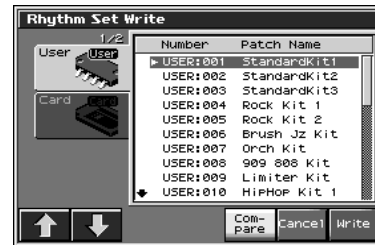

TIP

By pressing [F6 (Compare)] you can check the save-destination Rhythm set (Compare function).

7. Press [F8 (Write)].

A message will ask you for confirmation.

NOTE

Never switch off the Fantom-X while data is being saved.

8. Press [F8 (Exec)] to execute the save operation. To cancel the operation, press [F7 (Cancel)].

* To cancel, press [F7 (Cancel)].

Auditioning the Save-Destination Rhythm Set (Compare)

Before you save a rhythm set, you can audition the rhythm set which currently occupies the save destination to make sure that it is one you don't mind overwriting. This can help prevent important rhythm sets from being accidentally overwritten and lost.

1. Follow the procedure in "Saving Rhythm Sets You've Created (Write)" through step 5 to select the save destination.

2. Press [F7 (Compare)] to light it into red.

The Rhythm Compare window appears, making it possible to sound the currently selected save destination rhythm set.

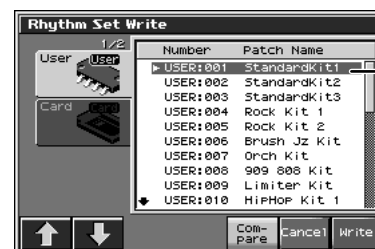

3. Play the keyboard or pad to sound the save destination rhythm set, then check whether you really want to overwrite it.

NOTE

The rhythm set auditioned using the Compare function may sound slightly different than when it is played normally.

4. If you wish to change the save destination, re-specify the save-destination rhythm set by using ▲ or ▼.
5. Press [F7 (Write)].
6. Press [F8 (Exec)] once again to execute the Save operation.

Functions of Rhythm Set Parameters

This section explains the functions the different rhythm set parameters have, as well as the composition of these parameters.

If a number is displayed for the parameter name, (❶ , ❷ , ❸ , ❹), you can use the realtime controller knob of the corresponding number (the left most knob is number 1, the right most knob is number 4) to set the value.

When you enter the Rhythm Edit screen, the indicator at the right of the Realtime Control knobs will go out, and the Realtime Control knobs can be used to edit the parameters of the patch or rhythm set. If you once again press the button located at the right of the Realtime Control knobs to make the indicator light, the knobs will control their original functions. When you exit the Rhythm Edit screen, the indicator will automatically return to its previous lit state.

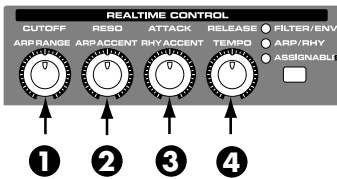

Making Settings Common to the Entire Rhythm Set (General)

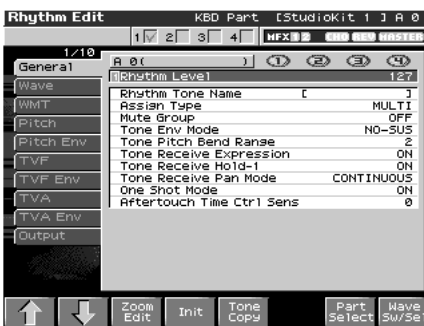

cf. →

For details on these settings, refer to “How to make Rhythm Set settings” (p. 83).

NOTE

Rhythm Level applies to the entire rhythm set; the other parameters are set individually for each rhythm tone.

Rhythm Level (Rhythm Set Level) ❶

Sets the volume of the rhythm set.

Value: 0–127

TIP

The volume levels of the tones from which the rhythm set is composed is set with the Tone Level parameter (p. 94). The volume levels of the Waves from which the rhythm tone is composed is set with the Wave Level parameter (p. 90).

Tone Name (Rhythm Tone Name)

You can assign a name of up to 12 characters to the rhythm tone.

Value: space, A-Z, a-z, 0-9, ! " # \$ % & ' () * + , - . / : ; < = > ? @ [\] ^ _ ` { | }

cf. →

For details on assigning names, refer to “Assigning a Name” (p. 36)

Assign Type

Assign Type sets the way sounds are played when the same key is pressed a number of times.

Value

MULTI:

Layer the sound of the same keys. Even with continuous sounds where the sound plays for an extended time, such as with crash cymbals, the sounds are layered, without previously played sounds being eliminated.

SINGLE:

Only one sound can be played at a time when the same key is pressed. With continuous sounds where the sound plays for an extended time, the previous sound is stopped when the following sound is played.

Mute Group

On an actual acoustic drum set, an open hi-hat and a closed hi-hat sound can never occur simultaneously. To reproduce the reality of this situation, you can set up a Mute Group.

The Mute Group function allows you to designate two or more rhythm tones that are not allowed to sound simultaneously. Up to 31 Mute Groups can be used. rhythm tones that are not belong to any such group should be set to “OFF.”

Value: OFF, 1–31

Tone Env Mode (Rhythm Tone Envelope Mode)

When a loop waveform (p. 85) is selected, the sound will normally continue as long as the key is pressed. If you want the sound to decay naturally even if the key remains pressed, set this to “NO SUS.”

Value: NO-SUS, SUSTAIN

NOTE

If a one-shot type Wave (p. 85) is selected, it will not sustain even if this parameter is set to “SUST.”

Creating a Rhythm Set

Tone Pitch Bend Range (Rhythm Tone Pitch Bend Range)

Specifies the amount of pitch change in semitones (4 octaves) that will occur when the Pitch Bend Lever is moved. The amount of change when the lever is tilted is set to the same value for both left and right sides.

Value: 0–48

Tone Receive Expression (Rhythm Tone Receive Expression Switch)

For each rhythm tone, specify whether MIDI Expression messages will be received (ON), or not (OFF).

Value: OFF, ON

Tone Receive Hold-1 (Rhythm Tone Receive Hold-1 Switch)

For each rhythm tone, specify whether MIDI Hold-1 messages will be received (ON), or not (OFF).

Value: OFF, ON

NOTE

If “NO SUS” is selected for Env Mode parameter (p. 87), this setting will have no effect.

Tone Receive Pan Mode (Rhythm Tone Receive Pan Mode)

For each rhythm tone, specify how pan messages will be received.

Value

CONTINUOUS: Whenever Pan messages are received, the stereo position of the tone will be changed.

KEY-ON: The pan of the tone will be changed only when the next note is played. If a pan message is received while a note is sounding, the panning will not change until the next key is pressed.

NOTE

The channels cannot be set so as not to receive Pan messages.

One Shot Mode

The sound will play back until the end of the waveform (or the end of the envelope, whichever comes first). The result will be the same as when the envelope’s Tone Env Mode parameter (p. 87) is set to NO-SUS. If you have set Wave Group (p. 88) to Sample, the loop setting will be forced to ONE SHOT.

Value: OFF, ON

Aftertouch Time Ctrl Sens (Sensitivity)

If Wave Group is set to SAMPLE and Tempo Sync is ON, aftertouch will control the amount of time stretching/shrinking caused by Time Stretch. If Time Stretch is not being applied, nothing will happen. If the stretch/shrink time will become shorter, and if set to “-” the time will become longer.

Value: -63–+63

Modifying Waveforms (Wave)

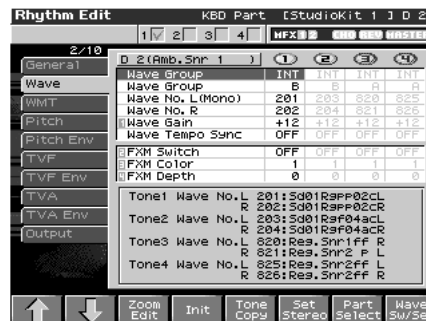

cf.

For details on these settings, refer to “How to make Rhythm Set settings” (p. 83).

MEMO

With rhythm tones, sounds are created by combining up to four Waves (eight for stereo).

Tips on Creating a Rhythm Tone

The Waves for the bass drum, snare, hi-hat, toms, and other percussion instruments are each assigned to one rhythm tone. When adding 3D effects to the sound, make the Pan settings for each rhythm tone individually.

Wave Group

Select the groups containing the Waves comprising the rhythm tone.

Value

INT: Waveforms stored in internal

EXP: Waveform stored in a Wave Expansion Board (SRX series) installed in EXP slots.

SMAP: Sample waveforms

MSAM: Multisample waveforms

NOTE

You cannot select a waveform group of a Wave Expansion Board that is not installed.

Wave Bank

Select the wave bank.

Value

When the wave group is EXP: A-D

When the wave group is SAMP: PRST, USER, CARD

When the wave group is MSAM: USER, CARD

Wave No. L (Mono) (Wave Number L (Mono)) Wave No. R (Wave Number R)

This selects the Waves comprising the rhythm tone. Along with the Wave number, the Wave name appears at the lower part of the display.

When in monaural mode, only the left side (L) is specified. When in stereo, the right side (R) is also specified.

Value: —, 1–1228 (The upper limit will depend on the wave group.)

MEMO

If you want to select a left/right pair of Waves, select the left (L) Wave number and then press [F6 (Set Stereo)]; the right (R) (Wave) will be recalled.

* When using a multisample in stereo, you must specify the same number for L and R.

Wave Tempo Sync ①

When you wish to synchronize a Phrase Loop to the clock (tempo), set this to “ON.” This is valid only when a separately sold wave expansion board is installed, and a waveform that indicates a tempo (BPM) is selected as the sample for a wave.

Value: OFF, ON

NOTE

If a waveform from a wave expansion board is selected for the tone, turning the Wave Tempo Sync parameter “ON” will cause pitch-related settings (p. 91) and FXM-related settings (p. 89) to be ignored.

- If a sample is selected for a tone, you must first set the BPM (tempo) parameter of the sample.
- If a sample is selected for a tone, Wave Tempo Sync will require twice the normal number of voices.

Phrase Loop

Phrase loop refers to the repeated playback of a phrase that’s been pulled out of a song (e.g., by using a sampler). One technique involving the use of Phrase Loops is the excerpting of a Phrase from a pre-existing song in a certain genre, for example dance music, and then creating a new song with that Phrase used as the basic motif. This is referred to as “Break Beats.”

Realtime Time Stretch

If the wave group is “SAMP” or “MSAM,” and the Wave Tempo Sync parameter is turned “ON,” you can vary the playback speed of the waveform without affecting the pitch.

Wave Gain ①

Sets the gain (amplification) of the waveform. The value changes in 6 dB (decibel) steps—an increase of 6 dB doubles the waveform’s gain.

Value: -6, 0, +6, +12

FXM Switch ②

This sets whether FXM will be used (ON) or not (OFF).

Value: OFF, ON

FXM

FXM (Frequency Cross Modulation) uses a specified waveform to apply frequency modulation to the currently selected waveform, creating complex overtones. This is useful for creating dramatic sounds or sound effects.

FXM Color ③

Specifies how FXM will perform frequency modulation. Higher settings result in a grainier sound, while lower settings result in a more metallic sound.

Value: 1–4

FXM Depth ④

Specifies the depth of the modulation produced by FXM.

Value: 0–16

NOTE

When the Tempo Sync parameter is set to “ON,” settings related to Pitch (p. 91) and FXM (p. 89) are disabled.

Changing How a Rhythm Tone Is Sounded (WMT)

The WMT (Wave Mix Table) uses key velocity to control the four waveforms assigned to the rhythm tone.



cf.

For details on these settings, refer to “How to make Rhythm Set settings” (p. 83).

Wave Coarse Tune ①

Adjusts the pitch of the waveform’s sound up or down in semitone steps (+/- octaves).

Value: -48– +48

TIP

The Coarse Tune of the entire rhythm tone is set by the Tone Coarse parameter (p. 91).

Creating a Rhythm Set

Wave Fine Tune ②

Adjusts the pitch of the waveform's sound up or down in 1-cent steps (+/-50 cents).

Value: -50– +50

MEMO

One cent is 1/100th of a semitone.

TIP

The Fine Tune of the entire rhythm tone is set by the Tone Fine Tune parameter (p. 91).

Wave Level ③

You can set the volume of the waveform.

Value: 0–127

TIP

The volume level of each rhythm tone is set with the Tone Level parameter; the volume levels of the entire rhythm set is set with the Rhythm Level parameter (p. 87).

Wave Pan ④

This specifies the pan of the waveform. "L64" is far left, "0" is center, and "63R" is far right.

Value: L63–0–63R

Wave Rnd Pan Sw (Wave Random Pan Switch)

Use this setting to cause the waveform's panning to change randomly each time a key is pressed (ON) or not (OFF).

Value: OFF, ON

* The range of the panning change is set by the Rnd Pan Depth parameter (p. 94).

WMT Velocity Control (Velocity Control Switch)

WMT Velocity Control determines whether a different rhythm tone is played (ON) or not (OFF) depending on the force with which the key is played (velocity).

When set to "RND," the rhythm set's constituent rhythm tones will sound randomly, regardless of any Velocity messages.

Value: OFF, ON, RANDOM

Wave Alter Pan Sw (Wave Alternate Pan Switch)

This setting causes panning of the waveform to be alternated between left and right each time a key is pressed. Set Alternate Pan Switch to "ON" to pan the Wave according to the Alter Pan Depth parameter (p. 94) settings, or to "REV" when you want the panning reversed. If you do not want the panning to change each time a key is pressed, set this to "OFF."

Range: OFF, ON, REV

Velo Fade Lower (Velocity Fade Width Lower)

This determines what will happen to the tone's level when the tone is played at a velocity lower than its specified velocity range. Higher settings produce a more gradual change in volume. If you want notes played outside the specified key velocity range to not be sounded at all, set this to "0."

Value: 0–127

Velo Range Lower (Velocity Range Lower)

This sets the lowest velocity at which the waveform will sound. Make these settings when you want different waveforms to sound in response to notes played at different strengths.

Value: 1–UPPER

Velo Range Upper (Velocity Range Upper)

This sets the highest velocity at which the waveform will sound. Make these settings when you want different waveforms to sound in response to notes played at different strengths.

Value: LOWER–127

NOTE

If you attempt to set the Lower velocity limit above the Upper, or the Upper below the Lower, the other value will automatically be adjusted to the same setting.

Velo Fade Upper (Velocity Fade Width Upper)

This determines what will happen to the tone's level when the tone is played at a velocity greater than its specified velocity range. Higher settings produce a more gradual change in volume. If you want notes played outside the specified key velocity range to not be sounded at all, set this to "0."

Value: 0–127



Modifying Pitch (Pitch/Pitch Env)



cf.

For details on these settings, refer to "How to make Rhythm Set settings" (p. 83).

Pitch

Tone Coarse Tune (Rhythm Tone Coarse Tune)

①

Selects the pitch at which a rhythm tone sounds.

Value: C-1–G9

TIP

Set the coarse tuning for Waves comprising the rhythm tones with the Wave Coarse Tune parameter (p. 89).

Tone Fine Tune (Rhythm Tone Fine Tune) ②

Adjusts the pitch of the rhythm tone's sound up or down in 1-cent steps (+/-50 cents).

Value: -50– +50

MEMO

One cent is 1/100th of a semitone.

TIP

Set the fine tuning for Waves comprising the rhythm tones with the Wave Fine Tune parameter (p. 90).

Tone Random Pitch Depth ③

This specifies the width of random pitch deviation that will occur each time a key is pressed. If you do not want the pitch to change randomly, set this to "0." These values are in units of cents (1/100th of a semitone).

Value: 0, 1, 2, 3, 4, 5, 6, 7, 8, 9, 10, 20, 30, 40, 50, 60, 70, 80, 90, 100, 200, 300, 400, 500, 600, 700, 800, 900, 1000, 1100, 1200

Pitch Env

P-Env Depth (Envelope Depth)

Adjusts the effect of the Pitch Envelope. Higher settings will cause the pitch envelope to produce greater change. Negative (-) settings will invert the shape of the envelope.

Value: -12– +12

P-Env V-Sens (Pitch Envelope Velocity Sensitivity)

Keyboard playing dynamics can be used to control the depth of the pitch envelope. If you want the pitch envelope to have more effect for strongly played notes, set this parameter to a positive (+) value. If you want the pitch envelope to have less effect for strongly played notes, set this to a negative (-) value.

Value: -63– +63

P-Env T1 V-Sens (Pitch Envelope Time 1 Velocity Sensitivity)

This allows keyboard dynamics to affect the Time 1 of the Pitch envelope. If you want Time 1 to be speeded up for strongly played notes, set this parameter to a positive (+) value. If you want it to be slowed down, set this to a negative (-) value.

Value: -63– +63

P-Env T4 V-Sens (Pitch Envelope Time 4 Velocity Sensitivity)

Use this parameter when you want key release speed to affect the Time 4 value of the pitch envelope. If you want Time 4 to be speeded up for quickly released notes, set this parameter to a positive (+) value. If you want it to be slowed down, set this to a negative (-) value.

Value: -63– +63

P-Env Time 1–4 (Pitch Envelope Time 1–4) ①, ②, ④

Specify the pitch envelope times (Time 1–Time 4). Higher settings will result in a longer time until the next pitch is reached. (For example, Time 2 is the time over which the pitch changes from Level 1 to Level 2.)

Value: 0–127

P-Env Level 0–4 (Pitch Envelope Level 0–4) ③

Specify the pitch envelope levels (Level 0–Level 4). It determines how much the pitch changes from the reference pitch (the value set with Coarse Tune or Fine Tune on the Pitch screen) at each point. Positive (+) settings will cause the pitch to be higher than the standard pitch, and negative (-) settings will cause it to be lower.

Value: -63– +63

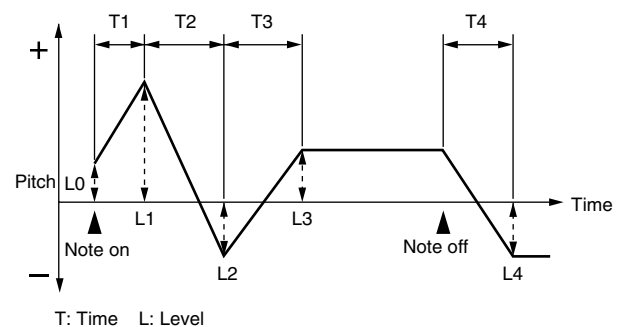

Modifying the Brightness of a Sound with a Filter (TVF/TVF Env)

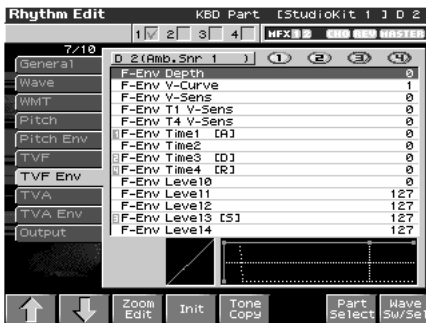

cf. →

For details on these settings, refer to “How to make Rhythm Set settings” (p. 83).

TVF

Filter Type ③

Selects the type of filter. A filter cuts or boosts a specific frequency region to change a sound's brightness, thickness, or other qualities.

Value

- OFF:** No filter is used.
- LPF:** Low Pass Filter. This reduces the volume of all frequencies above the cutoff frequency (Cutoff Freq) in order to round off, or un-brighten the sound. This is the most common filter used in synthesizers.
- BPF:** Band Pass Filter. This leaves only the frequencies in the region of the cutoff frequency (Cutoff Frequency), and cuts the rest. This can be useful when creating distinctive sounds.
- HPF:** High Pass Filter. This cuts the frequencies in the region below the cutoff frequency (Cutoff Frequency). This is suitable for creating percussive sounds emphasizing their higher ones.
- PKG:** Peaking Filter. This emphasizes the frequencies in the region of the cutoff frequency (Cutoff Frequency). You can use this to create wah-wah effects by employing an LFO to change the cutoff frequency cyclically.
- LPF2:** Low Pass Filter 2. Although frequency components above the Cutoff frequency (Cutoff Frequency) are cut, the sensitivity of this filter is half that of the LPF. This makes it a comparatively warmer low pass filter. This filter is good for use with simulated instrument sounds such as the acoustic piano.
- LPF3:** Low Pass Filter 3. Although frequency components above the Cutoff frequency (Cutoff Frequency) are cut, the sensitivity of this filter changes according to the Cutoff frequency. While this filter is also good for use with simulated acoustic instrument sounds, the nuance it exhibits differs from that of the LPF2, even with the same TVF Envelope settings.

NOTE

If you set “LPF2” or “LPF3,” the setting for the Resonance parameter will be ignored.

Cutoff Frequency ①

Selects the frequency at which the filter begins to have an effect on the waveform's frequency components.

Value: 0–127

With “LPF/LPF2/LPF3” selected for the Filter Type parameter, lower cutoff frequency settings reduce a tone's upper harmonics for a more rounded, warmer sound. Higher settings make it sound brighter.

If “BPF” is selected, harmonic components will change depending on the TVF Cutoff Frequency setting. This can be useful when creating distinctive sounds.

With “HPF” selected, higher Cutoff Frequency settings will reduce lower harmonics to emphasize just the brighter components of the sound.

With “PKG” selected, the harmonics to be emphasized will vary depending on Cutoff Frequency setting.

Resonance ②

Emphasizes the portion of the sound in the region of the cutoff frequency, adding character to the sound. Excessively high settings can produce oscillation, causing the sound to distort.

Value: 0–127

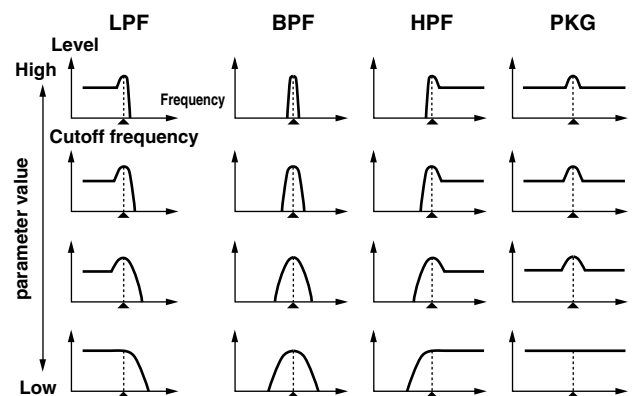

Cutoff V-Curve (Cutoff Frequency Velocity Curve)

Selects one of the following seven curves that determine how keyboard playing dynamics (velocity) influence the cutoff frequency. Set this to “FIXED” if you don't want the Cutoff frequency to be affected by the keyboard velocity.

Value: FIXED, 1–7

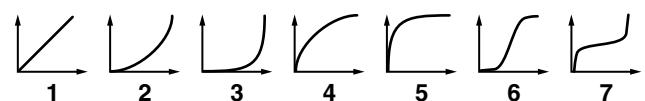

Cutoff V-Sens (Cutoff Velocity Sensitivity)

Use this parameter when changing the cutoff frequency to be applied as a result of changes in playing velocity. If you want strongly played notes to raise the cutoff frequency, set this parameter to positive (+) settings. If you want strongly played notes to lower the cutoff frequency, use negative (-) settings.

Value: -63– +63

Resonance V-Sens (Resonance Velocity Sensitivity)

This allows keyboard velocity to modify the amount of Resonance. If you want strongly played notes to have a greater Resonance effect, set this parameter to positive (+) settings. If you want strongly played notes to have less Resonance, use negative (-) settings.

Value: -63– +63

TVF Env

F-Env Depth (TVF Envelope Depth)

Specifies the depth of the TVF envelope. Higher settings will cause the TVF envelope to produce greater change. Negative (-) settings will invert the shape of the envelope.

Value: -63– +63

F-Env V-Curve (TVF Envelope Velocity Curve)

Selects one of the following 7 curves that will determine how keyboard playing dynamics will affect the TVF envelope. Set this to "FIXED" if you don't want the TVF Envelope to be affected by the keyboard velocity.

Value: FIX, 1–7

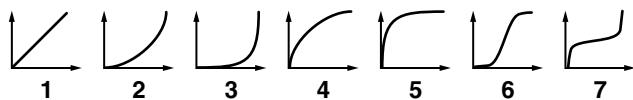

F-Env V-Sens (TVF Envelope Velocity Sensitivity)

Specifies how keyboard playing dynamics will affect the depth of the TVF envelope. Positive (+) settings will cause the TVF envelope to have a greater effect for strongly played notes, and negative (-) settings will cause the effect to be less.

Value: -63– +63

F-Env T1 V-Sens (TVF Envelope Time 1 Velocity Sensitivity)

This allows keyboard dynamics to affect the Time 1 of the TVF envelope. If you want Time 1 to be speeded up for strongly played notes, set this parameter to a positive (+) value. If you want it to be slowed down, set this to a negative (-) value.

Value: -63– +63

F-Env T4 V-Sens (TVF Envelope Time 4 Velocity Sensitivity)

The parameter to use when you want key release speed to control the Time 4 value of the TVF envelope. If you want Time 4 to be speeded up for quickly released notes, set this parameter to a positive (+) value. If you want it to be slowed down, set this to a negative (-) value.

Value: -63– +63

F-Env Time 1–4 (TVF Envelope Time 1–4)

1, 2, 4

Specify the TVF envelope times (Time 1– Time 4). Higher settings will lengthen the time until the next cutoff frequency level is reached. (For example, Time 2 is the time over which Level 1 will change to Level 2.)

Value: 0–127

F-Env Level 0–4 (TVF Envelope Level 0–4) 3

Specify the TVF envelope levels (Level 0–Level 4). These settings specify how the cutoff frequency will change at each point, relative to the standard cutoff frequency (the cutoff frequency value specified in the TVF screen).

Value: 0–127

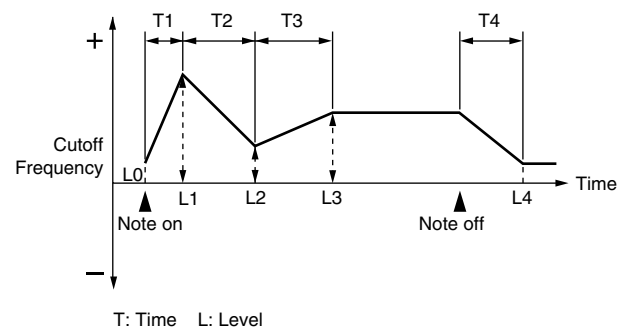

Creating a Rhythm Set

Adjusting the Volume (TVA/TVA Env)

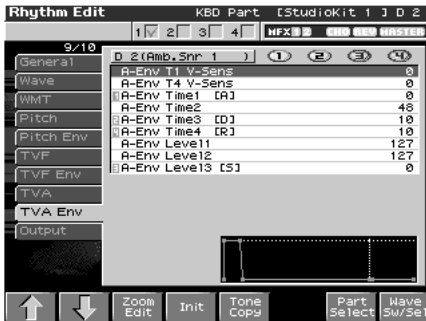

cf.

For details on these settings, refer to “How to make Rhythm Set settings” (p. 83).

TVA

Tone Level (Rhythm Tone level) ①

Sets the volume of the rhythm tone. Use this parameter to adjust the volume balance between rhythm tones.

Value: 0–127

TIP

The volume levels of the Waves from which the rhythm tone is composed is set with the WMT1–4 Wave Level parameter (p. 90).

Level V-Curve (Level Velocity Curve)

You can select from seven curves that determine how keyboard playing strength will affect the volume. If you do not want the volume of the rhythm tone to be affected by the force with which you press the key, select “FIXED.”

Value: FIXED, 1–7

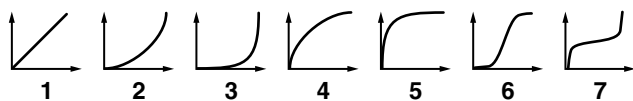

Level V-Sens (Level Velocity Sensitivity)

Set this when you want the volume of the rhythm tone to change depending on the force with which you press the keys. Set this to a positive (+) value to have the changes in rhythm tone volume increase the more forcefully the keys are played; to make the tone play more softly as you play harder, set this to a negative (-) value.

Value: -63– +63

Tone Pan (Rhythm Tone Pan) ②

Sets the pan for the rhythm tone. “L64” is far left, “0” is center, and “63R” is far right.

Value: L64–0–63R

TIP

Set the Pan for Waves comprising the rhythm tones with the Wave Pan parameter (p. 90).

Random Pan Depth ③

Use this parameter when you want the stereo location to change randomly each time you press a key. Higher settings will produce a greater amount of change.

Value: 0–63

NOTE

This will affect only waves whose Wave Rnd Pan Sw parameter (p. 90) is ON.

Alternate Pan Depth ④

This setting causes panning to be alternated between left and right each time a key is pressed. Higher settings will produce a greater amount of change. “L” or “R” settings will reverse the order in which the pan will alternate between left and right. For example if two rhythm tones are set to “L” and “R” respectively, the panning of the two rhythm tones will alternate each time they are played.

Value: L63–0–63R

NOTE

This will affect only waves whose Wave Alter Pan Sw parameter (p. 90) is ON or REV.

TVA Env

A-Env T1 V-Sens (TVA Envelope Time 1 Velocity Sensitivity)

This allows keyboard dynamics to affect the Time 1 of the TVA envelope. If you want Time 1 to be speeded up for strongly played notes, set this parameter to a positive (+) value. If you want it to be slowed down, set this to a negative (-) value.

Value: -63– +63

A-Env T4 V-Sens (TVA Envelope Time 4 Velocity Sensitivity)

The parameter to use when you want key release speed to control the Time 4 value of the TVA envelope. If you want Time 4 to be speeded up for quickly released notes, set this parameter to a positive (+) value. If you want it to be slowed down, set this to a negative (-) value.

Value: -63– +63

A-Env Time 1–4 (TVA Envelope Time 1–4) ① , ② , ④

Specify the TVA envelope times (Time 1– Time 4). Higher settings will lengthen the time until the next volume level is reached. (For example, Time 2 is the time over which Level 1 will change to Level 2.)

Value: 0–127

A-Env Level 1-3 (TVA Envelope Level 1-3) ③

Specify the TVA envelope levels (Level 1–Level 3). These settings specify how the volume will change at each point, relative to the standard volume (the Rhythm Tone Level value specified in the TVA screen).

Value: 0–127

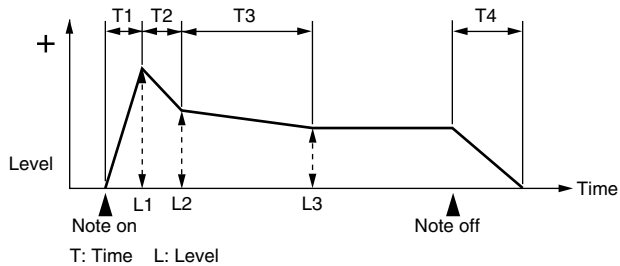

Output Settings (Output)

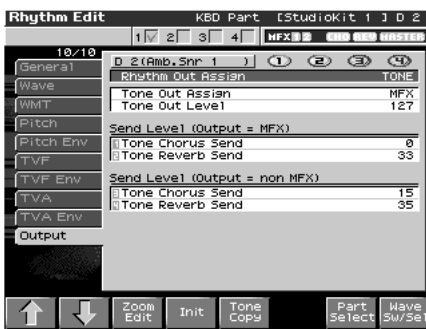

cf.

For details on these settings, refer to “How to make Rhythm Set settings” (p. 83).

Rhythm Out Assign

Specifies for each rhythm set how the direct sound will be output.

Value:

- MFx:** Output in stereo through multi-effects. You can also apply chorus or reverb to the sound that passes through multi-effects.
- A, B:** Output to the OUTPUT A (MIX) jack or OUTPUT B jack in stereo without passing through multi-effects.
- 1–4:** Output to the INDIVIDUAL 1–4 jacks in mono without passing through multi-effects.

NOTE

If you've made settings so that sounds are separately routed to the INDIVIDUAL 1 jack and INDIVIDUAL 2 jack, but no plug is actually inserted in the INDIVIDUAL 2 jack, the sounds routed to INDIVIDUAL 1 and INDIVIDUAL 2 will be mixed and output from the INDIVIDUAL 1 jack.

MEMO

If the Mix/Parallel parameter is set to “MIX,” all sounds are output from the OUTPUT A (MIX) jacks in stereo (p. 230).

Tone Out Assign

Specifies how the direct sound of each tone will be output.

Value:

- MFx:** Output in stereo through multi-effects. You can also apply chorus or reverb to the sound that passes through multi-effects.
- A, B:** Output to the OUTPUT A (MIX) jack or OUTPUT B jack in stereo without passing through multi-effects.
- 1–4:** Output to the INDIVIDUAL 1–4 jacks in mono without passing through multi-effects.

NOTE

If the Rhythm Output Assign is set to anything other than “TONE,” these settings will be ignored.

NOTE

If you've made settings so that sounds are separately routed to the INDIVIDUAL 1 jack and INDIVIDUAL 2 jack, but no plug is actually inserted in the INDIVIDUAL 2 jack, the sounds routed to INDIVIDUAL 1 and INDIVIDUAL 2 will be mixed and output from the INDIVIDUAL 1 jack.

- * If the Mix/Parallel parameter is set to “MIX,” all sounds are output from the OUTPUT A (MIX) jacks in stereo (p. 230).
- * If you've set Tone Out Assign to “MFx,” set the MFx Output Assign parameter (p. 208) to specify the output destination of the sound that has passed through the multi-effects.
- * Chorus and reverb are output in mono at all times.
- * The output destination of the signal after passing through the chorus is set with the Chorus Output Select (p. 209) and the Chorus Output Assign (p. 209).
- * The output destination of the signal after passing through the reverb is set with the Reverb Output Assign (p. 212).

Tone Out Level

Set the level of the signal that is sent to the output destination specified by Patch/Tone Output Assign.

Value: 0–127

Tone Chorus Send (Send Level (Output=MFx))

①

Specifies the level of the signal sent to the chorus for each tone if the tone is sent through MFx.

Value: 0–127

Tone Reverb Send (Send Level (Output=MFx))

②

Specifies the level of the signal sent to the reverb for each tone if the tone is sent through MFx.

Value: 0–127

Tone Chorus Send (Send Level (Output=non MFX)) ③

Sets the level of the signal sent to chorus for each tone if the tone is not sent through MFX.

Value: 0–127

Tone Reverb Send (Send Level (Output=non MFX)) ④

Sets the level of the signal sent to reverb for each tone if the tone is not sent through MFX.

Value: 0–127

Setting Effects for a Rhythm Set (Effects/MFX/MFX Control/Chorus/Reverb)

cf.

For details regarding effect settings, refer to the pages shown below.

- “Applying Effects in Patch Mode” (p. 207)
- “Making Multi-Effects Settings (MFX1–3)” (p. 213)
- “Making Chorus Settings (Chorus)” (p. 215)
- “Making Reverb Settings (Reverb)” (p. 216)

Playing in Performance Mode

A performance contains settings that apply to each individual part, such as the patch (rhythm set) assigned to each part, and its volume and pan.

Broadly speaking, Performance mode consists of two screens: Layer screen and Mixer screen.

Use the Layer screen when you want to combine multiple sounds (patches or rhythm sets) to create complex sounds. This lets you play patches together (“layer”) or play different patches in separate areas of the keyboard (“split”).

Use the Mixer screen when you want to mix the sounds by adjusting the level and pan for each of 16 parts.

When you play the keyboard, you will hear the current part and the parts whose keyboard switch has a check mark.

In addition to the settings of each part, the following settings can also be stored for each performance.

- Controller settings such as the D Beam, realtime control knobs, assignable switches, and pads
- Arpeggio and chord memory settings
- Rhythm group number

Displaying Performance Layer Screen

To access the Performance Layer screen, use the following procedure.

1. Press PERFORMANCE [LAYER/SPLIT].

You will enter Performance mode, and the Layer screen appears.

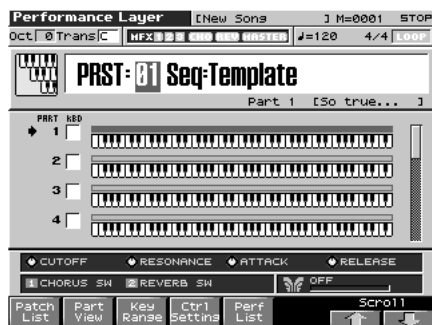

Displaying Performance Mixer Screen

To access the Performance Mixer screen, use the following procedure.

1. Press PERFORMANCE [MIXER].

You will enter Performance mode, and the Mixer screen appears.

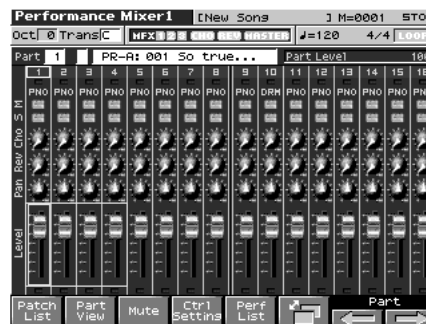

2. Press [F6] to switch the page.



Playing in Performance Mode

Functions in the PERFORMANCE Layer/Mixer Screen

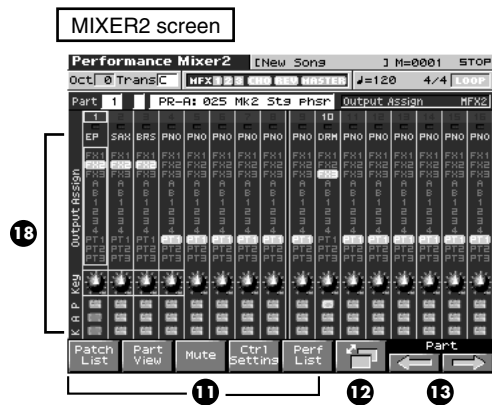
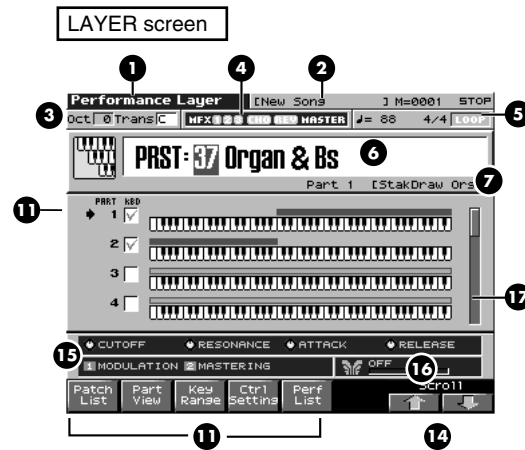
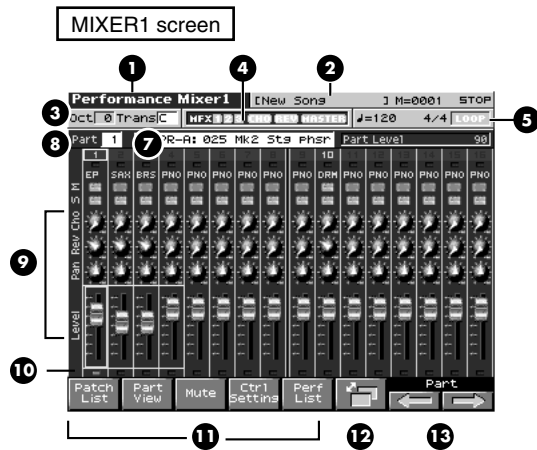

- 1 Indicates the current sound generating mode.
- 2 Indicates the name of the currently selected song, the measure location, the time signature, and the sequencer status.
- 3 Indicates the Octave Shift (Oct) and the Transpose (Trans).
- 4 Indicates multi-effects (MFX), chorus (CHO), reverb (REV) and mastering (MASTER) on and off.
- 5 Indicates the tempo at which the song, Arpeggio or rhythm pattern is played. Indicates the Loop Play on/off (LOOP).
- 6 MIXER screen: Indicates the group, number, and name of the selected performance. LAYER screen: Selects the group, number of the selected performance.
- 7 LAYER screen: Displays the patches assigned to the parts. When you switch the current part, the part number will also change.
- 8 Current Indicates the part.

- 9 Set the volume (LEVEL), pan (PAN), reverb (REV), chorus (CHO), Mute Sw (M), Solo Sw (S) of the part. The setting screen is divided into two screens, and you can press function button [F6] to switch between them.
- 10 Indicates the keyboard switch on/off.
- 11 Jumps to the setting screen of the displayed parameter.
- 12 Switches the MIXER screen 1 and 2.
- 13 These select the four parts that are controlled by the knobs. The currently selected parts are enclosed by a light green border. Use [CURSOR] (▲ or ▼) to select what is to be controlled.
- 14 Scrolls the settings through parts 1-16.
- 15 Indicates the functions that are assigned to each realtime controller knob (●) and assignable switch (■).
- 16 This indicates the function that is assigned to the D Beam controller, and the response status of the D Beam controller.
- 17 Indicates the key range in which you can play the keyboard or play rhythm sets.
- 18 Set the Part Course Tune (Key), Output Assign, Keyboard Sw (K) reverb (REV), Arpeggio Part (A), Pad Part (P) of the part. The setting screen is divided into two screens, and you can press function button [F6] to switch between them.

Selecting a Performance

The Fantom-X has two performance groups, including the User group and Preset groups, with each group storing 64 performances, for a total of 128 performances.

USER

This is the group inside the Fantom-X which can be rewritten. Performances you yourself create can be stored in this group. The Fantom-X contains 64 preset performances.

PRST (Preset)

This is the group inside the Fantom-X which cannot be rewritten. However you may modify the settings of the currently selected performance, and then store the modified performance in User memory. The Fantom-X contains 64 preset performances.

CARD (Memory Card)

This group lets you use patches stored on a memory card inserted in the rear panel PC card slot. Since the data in this group can be rewritten, you can use this group to store patches that you create.

1. Press [LAYER/SPLIT].
2. Press [CURSOR] to move the cursor to the performance group.

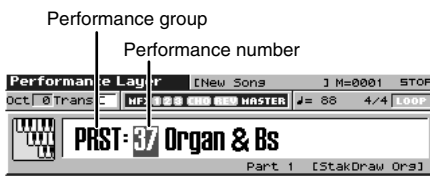

3. Turn the VALUE dial, or press [INC]/[DEC] to select a performance group.
USER: User
PRST: Preset
CARD: Memory Card
4. Press [CURSOR] to move the cursor to the performance number.
5. Turn the VALUE dial or press [INC]/[DEC] to select the performance number.

Selecting Performances from the List

You can display a list of performances and select a performance from that list.

1. Press [LAYER/SPLIT] or [MIXER].
2. Press [F5 (Perf List)].
 The Performance List screen appears.



3. To switch the performance group, press [F1(↑)] [F2(↓)] to move the cursor to the performance group tab, and press ▲ or ▼ to select the performance.
4. Press [F8 (Select)] to close the Performance List screen.

Creating a list of frequently used Patches and Performances (the Live Setting function)

You can create a list of frequently used sounds, and recall them instantly. Since you can register Patches, Rhythm Sets, or Performances, any type of sound you need can be recalled instantly regardless of the mode.

For details, refer to p. 42.

Playing in Performance Mode

Selecting Favorite Performances

You can bring together your favorite and most frequently used performances in one place by registering them in the Favorite Performance. By using this function you can quickly select your favorite performances.

cf.

For instructions on how to register to the Favorite Performance, refer to “Registering a Favorite Performance” (p. 100).

1. Press [LAYER/SPLIT] or [MIXER].
2. Press [F5 (Perf List)] and then press [F3 (Favorite)].

The Favorite List screen appears.



3. Press ▲ or ▼ to select a performance number.
To switch banks, press [F1 (↑)] [F2 (↓)].
4. Press [F8 (Select)] to select the patch.

Registering a Favorite Performance

You can bring together your favorite and most frequently used Performances in one place by registering them in the Favorite Performance. By using this function you can rapidly select favorite Performances from Preset/User/Card area or a Wave Expansion Board. You can register a total of 64 Performances (8 sounds x 8 banks) as favorite Performance.

cf.

For details on selecting a favorite performance, refer to “Selecting Favorite Performances” (p. 100).

1. Select the Performance that you wish to register (p. 99).
2. Press [F5 (Perf List)].

3. Press [F3 (Favorite)].

The Favorite List screen appears.

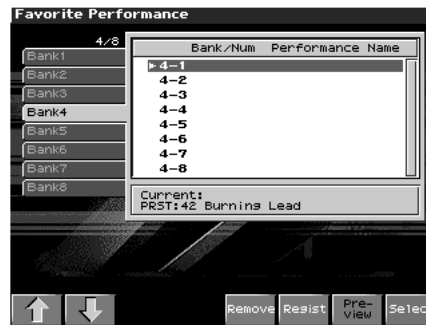

4. Press [F1 (↑)] [F2 (↓)] to select the bank in which you wish to register the Performance.
5. Press ▲ or ▼ to select the number to which you wish to register. The number you select here corresponds to [F1]–[F8].
6. Press [F6 (Regist)] to execute the registration.

* To cancel, press [EXIT].

TIP

By pressing [F5 (Remove)] you can cancel the Performance registration that is selected in the Favorite List screen.

Using the Layer Screen

Selecting a Part

The currently selected part is called the “current part.”

1. From the Layer screen, Use ▲ or ▼ to select the part.

The selected part is indicated by “.”



Selecting the Part that You want to Sound (Keyboard Switch)

Here's how to select the parts whose patch or rhythm set will sound. For each part, use the check box to specify whether that part will be played from the keyboard; this is called the "keyboard switch."

1. From the Layer screen, Use [CURSOR] to move the cursor to "KBD," and press [INC] to add a check mark (✓) to "KBD."

When you play the keyboard, you will hear the current part and the parts that have a check mark.

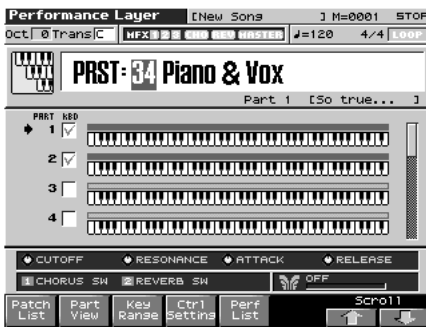

About the keyboard switch

Use the keyboard switch when you want to play multiple sounds layered together (Layer) or assign different sounds to different regions of the keyboard (Split). Conversely, you can turn off all keyboard switches when you are creating data, etc.

Selecting the Sound for a Part

If you don't like the patch that is assigned to a part, it's easy to switch the patch.

Selecting from a list display

1. Select the part whose sound you want to switch.
2. Press [F1 (Patch List)].

The Patch List screen will appear.



* To cancel, press [EXIT].

3. Use ▲ or ▼ to select a patch.

If you press [F4 (Patch Categ)], the list will show the categories. If you press [F5 (Patch)] or [F6 (Rhythm)], the list will show the patch groups.



To switch groups, press [F1 (⏏)] [F2 (⏏)].

By pressing [F7 (Preview)] you can audition a patch using a preselected phrase appropriate for that type (category) of patch (Phrase Preview).

4. Press [F8 (Select)] to select the patch.

Playing in Performance Mode

Combining and Playing Sounds Together (Layer)

In Performance mode you can play the sounds of all parts whose Internal Switch is on, and all connected parts. Combining the parts will produce, thicker, fatter sounds.

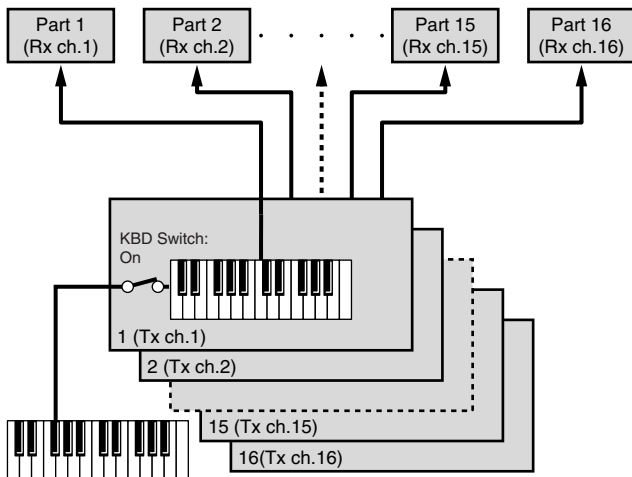

Rx ch.: Receive Channel
Tx ch.: Transmit Channel

1. Press [LAYER/SPLIT] to access the Layer screen.
2. Press ▲ or ▼ to select the part you want to play.
The Performance Edit screen appears.
3. Press [INC] to add a check mark to the part that you want to sound.
Pressing [DEC] will remove the check mark.
The bar shown above the keyboard indicates the range of keys that will sound.
When you play the keyboard, you will hear the current part and the parts whose keyboard switch has a check mark.
4. Repeat steps 2. 3. to turn the Internal Switch on for all parts that are connected to the parts you want to play.

Playing Different Sounds in Different Areas of the Keyboard (Split)

In Performance mode you can divide the keyboard and play a different patch in each area (this is called “split”). As the note range that plays each part can be specified individually, you can split the keyboard into a maximum of 16 sections.

For instance, you can play strings in the lower range, piano in the upper range, and both sounds in the middle range.

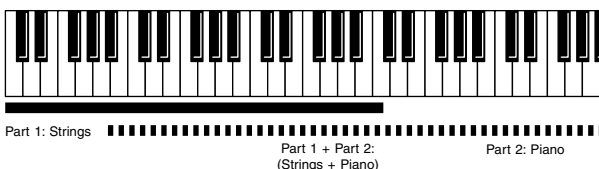

MEMO

A split performance is one application of a layer. Changing the key range of each part in the layer results in a split.

1. Press [LAYER/SPLIT] to access the Layer screen.
2. Press ▲ or ▼ to select the part you want to play.
3. Press [F3 (Key Range)].
4. Press [F3 (KBD)], move the cursor to the keyboard switch, and press [INC] to turn on the keyboard switch that is connected to the part you want to sound.
5. To set the lower limit of the range, use [F4 (Lower)] to move the cursor to “Key Range Lower.” To set the lower limit of the range, use [F5 (Upper)] to move the cursor to “Key Range Upper.”

Turn the VALUE dial or press [INC]/[DEC] to specify the range.

The bar shown above the keyboard indicates the range of keys that will sound.

NOTE

If you attempt to set the lower limit higher than the upper limit, or attempt to set the upper limit below the lower limit, the other setting will change with the same value.



Value: Key Range Lower: C-1-UPPER
Key Range Upper: LOWER-G9

TIP

By specifying sections for different parts so that they overlap each other, you can combine two or more parts only in a specific section.

6. When you are finished making settings, press [F8 (Close)] to return to the Performance Layer screen, and begin playing.

Using the Mixer Screen

Selecting Parts for a Layer or Split

The currently selected part is called the “current part.”

1. In the Mixer 2 screen, use ◀ or ▶ to select the part.

Current Part



- * Use [CURSOR] to move the “Part,” and turn VALUE dial or press [INC] [DEC] to select the part.

You can also select multiple parts in the Mixer screen.

2. In the Mixer 2 screen, press ▼ to move the cursor to the bottom of the screen.
3. Press [INC] to display “KBD,” and select the part that you want to sound.

When you play the keyboard, you will hear the current part and the parts whose keyboard switch has a check mark.



About the keyboard switch

Use the keyboard switch when you want to play multiple sounds layered together (Layer) or assign different sounds to different regions of the keyboard (Split). Conversely, you can turn off all keyboard switches when you are creating data, etc.

Selecting the Sound for a Part

You can switch the patch that is assigned to a part.

Selecting from a list display

1. Select the part whose sound you want to switch.
2. Press [F1 (Patch List)].

The Patch List screen will appear.



- * To cancel, press [EXIT].

3. Use ▲ or ▼ to select a patch.

If you press [F4 (Patch Categ)], the list will show the categories.

If you press [F5 (Patch)] or [F6 (Rhythm)], the list will show the patch groups.



To switch groups, press [F1 (⏏)] [F2 (⏏)].

By pressing [F7 (Preview)] you can audition a patch using a preselected phrase appropriate for that type (category) of patch (Phrase Preview).

4. Press [F8 (Select)] to select the patch.

Playing in Performance Mode

Selecting in the Mixer Screen

1. Press [MIXER] to access the MIXER screen.
2. Use ◀ or ▶ to select a part.
3. Use ▲ to move the cursor to the patch number.



4. Turn the VALUE dial or use [INC] [DEC] to select a patch.

Selecting the Rhythm Set

1. Press [MIXER] to access the MIXER screen.
2. Use ◀ or ▶ to select a part.
3. Use ▲ to move the cursor to the following location.



4. Turn the VALUE dial or press [INC] [DEC] to select "R."
The rhythm set will be selected.

Editing the Part Settings

In the Mixer screen you can set the following parameters for each part.

Performance Mixer1 screen

Parameter	Shown in the Mixer screen as
Part Level (p. 108)	Level
Part Pan (p. 108)	Pan
Part Reverb Send (p. 108)	Rev
Part Chorus Send (p. 108)	Cho
Solo Switch (p. 105)	S
Mute Switch (p. 105)	M

Performance Mixer2 screen

Parameter	Shown in the Mixer screen as
Keyboard Switch (p. 110)	K
Arpeggio Part (p. 130)	A
Pad Part (p. 161)	P
Part Coarse Tune (p. 109)	Key
Output Assign (p. 108)	Output Assign

1. Press [MIXER].

The Performance Mixer 1 screen will appear.

* If you want to edit the parameters of the Performance Mixer 2 screen, press [F6] to switch screens.



2. Use ▲ or ▼ to move the cursor to the parameter you want to edit.
3. Use ◀ or ▶ to move the cursor to the part that you want to edit.
4. Turn the VALUE dial or use [INC] [DEC] to set the desired value.

MEMO

The green border enclosing four parts corresponds to the four REALTIME CONTROL knobs.

Selecting a Part to Play Individually (Solo)

When playing back a song, you can choose to hear just a specific part play by itself.

1. Press [MIXER] to access the Mixer screen.
2. Use ▲ ▼ to move the cursor to the solo switch.
3. Turn the VALUE dial or press [INC] or [DEC] to turn the SOLO switch on/off.



MEMO

This setting is linked with the Solo Part Select parameter (Part View screen), and can be saved as a performance setting.

Silencing the Playback of a Specific Part (Mute)

When playing along with a song, you can turn off (i.e., mute) parts you don't want to hear. This allows you to turn off the melody part for karaoke applications or for practicing the muted part.

1. Press [MIXER] to access the Mixer screen.
2. Use ▲ ▼ to move the cursor to the mute switch.
3. Turn the VALUE dial or press [INC] or [DEC] to turn the MUTE switch on/off.



MEMO

Part Mute does not turn off the MIDI receive switch; rather, it sets the volume to the minimum setting to silence the sound. Therefore, MIDI messages are still received.

NOTE

Part Mute does not turn off the MIDI receive switch; rather, it sets the volume to the minimum setting to silence the sound. Therefore, MIDI messages are still received.

Using pads to mute Parts

You can use the pads to switch part muting on/off. Pad numbers 1–16 correspond to part numbers 1–16.

1. Press [MIXER] to access the Mixer screen.
2. Press [F3 (Mute)].
The Muting Parts with Dynamic Pads screen will appear.
At this time, the pads will function as mute on/off buttons; each time you press a pad, muting will be switched on or off.
 - Pad lit: muted
 - Pad unlit: not muted

TIP

Pressing [F6 (All Mute)] will mute all parts. Pressing [F7 (All Play)] will un-mute all parts.

Playing in Performance Mode

Viewing the Part Settings as a List (Performance Part View)

In Performance mode you can view the part settings as a list. This is called the “Part View” screen. In this screen you can view a list that shows settings for all parts at once, such as the patch assigned to each part, and its volume and pan settings. You can also edit these settings here, and make detailed settings that cannot be made in the Layer screen or Mixer screen.

1. Access the Performance Layer or Mixer screen.
2. Press [F2 (Part View)].

The Part View screen will appear.

For details on the setting, refer to “Viewing the Part Settings as a List (Performance Part View)” (p. 107).

Part	Patch	KBSOMU	Level	Pan
1	PR-E 077 Bosphorus	✓	127	0
2	PR-D 102 Silk Pad	✓	107	0
3	PR-A 105 Thick Steel	✓	101	0
4	PR-A 001 So true...	✓	100	0
5	PR-A 001 So true...	✓	100	0
6	PR-A 001 So true...	✓	100	0
7	PR-A 001 So true...	✓	100	0
8	PR-A 001 So true...	✓	100	0
9	PR-A 001 So true...	✓	100	0
10	PRST 032 Scrn&voi&Mid	✓	127	0
11	PR-A 001 So true...	✓	100	0
12	PR-A 001 So true...	✓	100	0
13	PR-A 001 So true...	✓	100	0
14	PR-A 001 So true...	✓	100	0
15	PR-A 001 So true...	✓	100	0
16	PR-A 001 So true...	✓	100	0

3. Press [F1 (Level/Pan)]–[F8 (MIDI Filter)] to select the screen.
4. Press [EXIT] to return to the Layer or Mixer screen.

Performing with the Arpeggio/Rhythm function

For details on using the Arpeggio and Rhythm functions, refer to “Playing Arpeggios” (p. 128),” and “Playing Rhythms” (p. 135).

Performing with the Realtime Controllers and D Beam Controller

For details on the setting, refer to “Make Settings for the Realtime Controllers and D Beam Controller (Ctrl)” (p. 114).

Viewing MIDI messages for each Part (Part Information)

In Performance mode, the reception status of MIDI messages that control various things can be viewed for each part. This is useful when you want to check whether the sound generator is responding correctly to the keyboard, or to operations from an external MIDI controller.

1. Access the Performance Layer or Mixer screen (p. 97).
2. Hold down [SHIFT] and press [F2 (Part Info)].
The Part Information window appears.

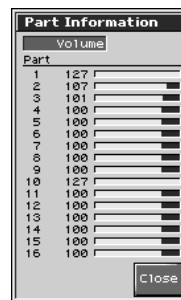

3. Turn VALUE dial or press [INC][DEC] to select the message that you want to check.
Modulation: Modulation messages
Breath: Breath messages
Foot Type: Foot type messages
Volume: Volume messages
Panpot: Panpot messages
Expression: Expression messages
Hold 1: Hold 1 messages
Pitch Bend: Pitch Bend messages
Aftertouch: Aftertouch messages
Voices: Voice messages (The number of voices used)
4. Press [F8 (Close)] to close the window.

Viewing the number of voices used by the sound generator (Voice Monitor)

For details, refer to “Viewing the number of voices used by the sound generator (Voice Monitor)” (p. 37).

Adjusting the Master Level

For details, refer to “How Do I Adjust the Volume?” (p. 229)

Creating a Performance

With the Fantom-X, you have total control over a wide variety of settings. Each item that can be set is known as a **parameter**. When you change the values of parameters, you are doing what is referred to as **Editing**. This chapter explains the procedures used in creating Performances, and the functions of the Performance parameters.

Viewing the Part Settings as a List (Performance Part View)

In Performance mode you can view the part settings as a list. This is called the “Part View” screen. In this screen you can view a list that shows settings for all parts at once, such as the patch assigned to each part, and its volume and pan settings. You can also edit these settings here, and make detailed settings that cannot be made in the Layer screen, or Mixer screen.

1. Access the Performance Layer or Mixer screen.
2. Press [F2 (Part View)].

The Part View screen will appear.

Part	Patch	KB	SOMU	Level	Pan
1	PR-E 077 Bosphorus	✓		127	0
2	PR-D 102 Silk Pad	✓		107	0
3	PR-R 105 Thick Steel	✓		101	0
4	PR-R 001 So true...		✓	100	0
5	PR-R 001 So true...		✓	100	0
6	PR-R 001 So true...		✓	100	0
7	PR-R 001 So true...		✓	100	0
8	PR-R 001 So true...		✓	100	0
9	PR-R 001 So true...		✓	100	0
10	PRST 032 Sch&Voi&Mid			127	0
11	PR-R 001 So true...		✓	100	0
12	PR-R 001 So true...		✓	100	0
13	PR-R 001 So true...		✓	100	0
14	PR-R 001 So true...		✓	100	0
15	PR-R 001 So true...		✓	100	0
16	PR-R 001 So true...		✓	100	0

Patch Number

Level Pan Output Effect Pitch Offset Key Range Scale Tune External MIDI Filter

3. When you have finished making settings, press [EXIT] to return to the LAYER/SPLIT or Mixer screen.

TIP

When the cursor is at a patch group or patch number, you can press [ENTER] to open the Patch List screen and choose a patch from the list (p. 41).

Adjusting the Parameters of Each Part

1. Access the Part View screen.
2. Press [F1 (Level/Pan)]–[F8 (MIDI Filter)] to select the parameter.

Part	Patch	KB	SOMU	Level	Pan
1	PR-D 005 Alpha Retro			100	0
2	PR-B 067 Kickin' Bass			100	0
3	PR-E 055 Brisk Vortex			90	0
4	PR-E 102 WaitnOutside			90	0
5	PR-R 001 So true...		✓	100	0
6	PR-R 001 So true...		✓	100	0
7	PR-R 001 So true...		✓	100	0
8	PR-R 001 So true...		✓	100	0
9	PR-R 001 So true...		✓	100	0
10	PRST 022 ArtificialKit			100	0
11	PR-R 001 So true...		✓	100	0
12	PR-R 001 So true...		✓	100	0
13	PR-R 001 So true...		✓	100	0
14	PR-R 001 So true...		✓	100	0
15	PR-R 001 So true...		✓	100	0
16	PR-R 001 So true...		✓	100	0

Patch Number

Level Pan Output Effect Pitch Offset Key Range Scale Tune External MIDI Filter

3. Use [CURSOR] to move the cursor to the parameter you want to change.
4. Turn the VALUE dial or press [INC]/[DEC], set the value.

* The name of the parameter at the cursor location is displayed in the bottom line of the Part View screen.

[F1 (Level/Pan)]

Patch Type

Sets the assignment of a patch (Patch) or rhythm set (Rhythm) to each of the parts.

Patch Bank

Selects the group to which the desired patch or rhythm set belongs.

Value

USER: User

PRA–H: Preset A–H

GM: GM (GM2)

CARD: Card

XP–A–D: Wave Expansion Boards installed in EXP–A–D Slots

Patch Number

Selects the desired patch or rhythm set by its number.

Value: 001–

Keyboard Switch

Specifies, for each part, whether or not the keyboard controller section will be connected to the internal sound generator.

Value: OFF, ON (✓)

Solo Switch

Check “✓” this setting if you want to hear the part by itself; this is called “soloing” the part.

Value: OFF, ON (✓)

Mute Switch

Mutes (✓) or un-mutes (OFF) each part.

Use this setting when, for example, you want to use the instrument for karaoke by muting the part playing the melody, or when you want to play something using a separate sound module.

Value: OFF, ON (✓)

MEMO

The Mute Switch parameter does not turn the part off, but sets the volume to minimum so that no sound is heard. Therefore, MIDI messages are still received.

Creating a Performance

Part Level

Adjust the volume of each part. This setting's main purpose is to adjust the volume balance between parts.

Value: 0–127

Part Pan

Adjust the pan of each part. “L64” is far left, “0” is center, and “63R” is far right.

Value: L64–0–63R

[F2 (Output Effect)]

Patch Name	Out	Output	Chorus	Reverb	1	2	3	C	R
1 Alpha Retro	PAT	1	127	0	0	0	0	0	0
2 Kickin' Bass	PAT	2	127	0	0	0	0	0	0
3 Britsk Vortex	PAT	1	127	0	0	0	0	0	0
4 Wait Outside	PAT	1	127	0	0	0	0	0	0
5 So true...	PAT	1	127	0	0	0	0	0	0
6 So true...	PAT	1	127	0	0	0	0	0	0
7 So true...	PAT	1	127	0	0	0	0	0	0
8 So true...	PAT	1	127	0	0	0	0	0	0
9 So true...	PAT	1	127	0	0	0	0	0	0
10 Artificial Kit	PAT	3	127	0	0	0	0	0	0
11 So true...	PAT	1	127	0	0	0	0	0	0
12 So true...	PAT	1	127	0	0	0	0	0	0
13 So true...	PAT	1	127	0	0	0	0	0	0
14 So true...	PAT	1	127	0	0	0	0	0	0
15 So true...	PAT	1	127	0	0	0	0	0	0
16 So true...	PAT	1	127	0	0	0	0	0	0

cf. →

For details on these settings, refer to “Adjusting the Parameters of Each Part” (p. 107).

Part Output Assign

Specifies for each part how the direct sound will be output.

Value

- MFX:** Output in stereo through multi-effects. You can also apply chorus or reverb to the sound that passes through multi-effects.
- A, B:** Output to the OUTPUT A (MIX) jack or OUTPUT B jack in stereo without passing through multi-effects.
- 1–4:** Output to the INDIVIDUAL 1–4 jacks in mono without passing through multi-effects.
- PAT:** The part's output destination is determined by the settings of the patch or rhythm set assigned to the part.

NOTE

If you've made settings so that sounds are separately routed to the INDIVIDUAL 1 jack and INDIVIDUAL 2 jack, but no plug is actually inserted in the INDIVIDUAL 2 jack, the sounds routed to INDIVIDUAL 1 and INDIVIDUAL 2 will be mixed and output from the INDIVIDUAL 1 jack.

MEMO

If the Mix/Parallel parameter is set to “MIX,” all sounds are output from the OUTPUT A (MIX) jacks in stereo (p. 230).

TIP

If you've set Tone Out Assign to “MFX,” set the MFX Output Assign parameter to specify the output destination of the sound that has passed through the multi-effects.

- Chorus and reverb are output in mono at all times.
- The output destination of the signal after passing through the chorus is set with the Chorus Output Select (p. 209) and the Chorus Output Assign (p. 209).
- The output destination of the signal after passing through the reverb is set with the Reverb Output Assign (p. 209).

Part Output MFX Select (Part Output Multi-Effects Select)

Of the three types of multi-effects that can be used simultaneously, specify which multi-effects will be used.

Value: 1–3 (MFX-1–MFX-3)

Part Output Level

Set the level of the signal that is sent to the output destination specified by Part Output Assign.

Value: 0–127

Part Chorus Send Level

Sets the level of the signal sent to chorus for each part.

Value: 0–127

Part Reverb Send Level

Sets the level of the signal sent to reverb for each part.

Value: 0–127

MFX1–3 Source

Chorus Source

Reverb Source

The settings of a specific patch can be used as the settings for MFX1 (1)–MFX3 (3), chorus (C), and reverb (R). This setting specifies the part to which this patch has been assigned.

If no part is selected, the settings of the Performance will be used.

MEMO

For the following parameters, settings can be made individually for each multi-effects (MFX1–MFX3) selected in Part Output MFX Select.

[F3 (Pitch)]

Part View		[New Song]		J M-0001		STOP	
Patch Name	Oct	Cr	Fine	M/P	Legato	Bend	Portamento
1 Alpha Retro	0	0	0	PAT	PAT	PAT	PAT
2 Kickin' Bass	0	0	0	PAT	PAT	PAT	PAT
3 Brisk Vortex	0	0	0	PAT	PAT	PAT	PAT
4 Waitn' Outside	0	0	0	PAT	PAT	PAT	PAT
5 So true...	0	0	0	PAT	PAT	PAT	PAT
6 So true...	0	0	0	PAT	PAT	PAT	PAT
7 So true...	0	0	0	PAT	PAT	PAT	PAT
8 So true...	0	0	0	PAT	PAT	PAT	PAT
9 So true...	0	0	0	PAT	PAT	PAT	PAT
10 Artificial Kit	0	0	0	PAT	PAT	PAT	PAT
11 So true...	0	0	0	PAT	PAT	PAT	PAT
12 So true...	0	0	0	PAT	PAT	PAT	PAT
13 So true...	0	0	0	PAT	PAT	PAT	PAT
14 So true...	0	0	0	PAT	PAT	PAT	PAT
15 So true...	0	0	0	PAT	PAT	PAT	PAT
16 So true...	0	0	0	PAT	PAT	PAT	PAT

cf.

For details on these settings, refer to “Adjusting the Parameters of Each Part” (p. 107).

Part Octave Shift

Adjusts the pitch of the part’s sound up or down in units of an octave (+/-3 octaves).

Value: -3– +3

NOTE

Note that when a rhythm set is assigned to a part, you cannot modify the Octave Shift parameter.

Part Coarse Tune

Adjusts the pitch of the part’s sound up or down in semitone steps (+/-4 octaves).

Value: -48– +48

Coarse Tune and Octave Shift

The Coarse Tune and Fine Tune parameters, along with the Octave Shift parameter, can all be seen as doing the same thing to the sound, i.e., changing the pitch of the sound. For example, if C4 (Middle C) is played with the Coarse Tune parameter set to “+12,” the note produced is C5 (one octave above C4). For example, if C4 (Middle C) is played with the Octave Shift parameter set to “+1,” the note produced is C5 (one octave above C4).

However, internally these function very differently. When the Coarse Tune parameter is set to “+12,” the pitch itself is raised one octave. On the other hand, when the Octave Shift parameter is set to “+1,” it is the same as pressing the keys one octave up. In other words, use the Coarse Tune parameter when changing the pitch, and the Octave Shift parameter when you want to shift the entire keyboard, for example, when the number of keys is insufficient.

Part Fine Tune

Adjusts the pitch of the part’s sound up or down in 1-cent steps (+/-50 cents).

Value: -50– +50

MEMO

One cent is 1/100th of a semitone.

Part Mono/Poly

Set this parameter to “MONO” when the patch assigned to the part is to be played monophonically, or to “POLY” when the patch is to be played polyphonically. If you want to use the Mono/Poly setting of the patch assigned to the part (p. 77), set this to “PAT.”

Value: MONO, POLY, PAT

NOTE

This setting is ignored for parts to which a rhythm set is assigned.

Part Legato Switch

You can add legato when performing monophonically. The term “legato” refers to a playing style in which notes are smoothly connected to create a flowing feel. This creates a smooth transition between notes, which is effective when you wish to simulate the hammering-on and pulling-off techniques used by a guitarist.

Turn this parameter “ON” when you want to use the Legato feature and “OFF” when you don’t. If you want to use the Legato Switch setting of the patch assigned to the part (p. 77), set this to “PAT.”

Value: OFF, ON, PAT

NOTE

This setting is ignored for parts to which a rhythm set is assigned.

Part Pitch Bend Range

Specifies the amount of pitch change in semitones (2 octaves) that will occur when the Pitch Bend Lever is moved. The amount of change when the lever is tilted is set to the same value for both left and right sides. If you want to use the Pitch Bend Range setting of the patch assigned to the part (p. 67), set this to “PAT.”

Value: 0–24, PAT

Part Portamento Switch

Specify whether portamento will be applied. Turn this parameter “ON” when you want to apply Portamento and “OFF” when you don’t. If you want to use the Portamento Switch setting of the patch assigned to the part (p. 77), set this to “PAT.”

Value: OFF, ON, PAT

Part Portamento Time

When portamento is used, this specifies the time over which the pitch will change. Higher settings will cause the pitch change to the next note to take more time. If you want to use the Portamento Time setting of the patch assigned to the part (p. 78), set this to “PAT.”

Value: 0–127, PAT

NOTE

This setting is ignored for parts to which a rhythm set is assigned.

[F4 (Offset)]

Part View						[New Song]	[M=0001]	STOP
Patch Name	Cutoff	Reso	Attack	Release	Decay			
1 Alpha Retro	0	0	0	0	0			
2 Kickin' Bass	0	0	0	0	0			
3 Brisk Vortex	0	0	0	0	0			
4 WaitnOutside	0	0	0	0	0			
5 So true...	0	0	0	0	0			
6 So true...	0	0	0	0	0			
7 So true...	0	0	0	0	0			
8 So true...	0	0	0	0	0			
9 So true...	0	0	0	0	0			
10 ArtificialKit	0	0	0	0	0			
11 So true...	0	0	0	0	0			
12 So true...	0	0	0	0	0			
13 So true...	0	0	0	0	0			
14 So true...	0	0	0	0	0			
15 So true...	0	0	0	0	0			
16 So true...	0	0	0	0	0			

Part Cutoff Offset

Level	Output	Pitch	Offset	Key	Scale	Exter-	MIDI
Pan	Effect			Range	Tune	nal	Filter

cf.

For details on these settings, refer to “Adjusting the Parameters of Each Part” (p. 107).

Part Cutoff Offset

Adjusts the cutoff frequency for the patch or rhythm set assigned to a part.

Value: -64+ +63

NOTE

Patches also have a Cutoff Offset setting (p. 61). The final Cutoff frequency value is the sum of the tone Cutoff Frequency value and the patch and part Cutoff Offset values. If the tone’s cutoff frequency is already set to “127” (maximum), there will be no change produced by setting the Cutoff Offset to a positive value.

Part Resonance Offset

Adjusts the Resonance for the patch or rhythm set assigned to a part.

Value: -64+ +63

NOTE

Patches also have a Resonance Offset setting (p. 62). The final Resonance value is the sum of the tone Resonance value and the patch and part Resonance Offset values. If the tone’s resonance is already set to “127” (maximum), there will be no change produced by setting the resonance offset to a positive value.

Part Attack Time Offset

Adjusts the TVA/TVF Envelope Attack Time for the patch or rhythm set assigned to a part.

Value: -64+ +63

NOTE

Patches also contain the Attack Time Offset setting (p. 62). The final TVA Envelope attack time value is therefore the sum of the tone’s TVA Envelope Time 1 setting, the patch’s Attack Time Offset, and the part’s Attack Time Offset. If the tone’s Time 1 parameter is already set to “127” (maximum), there will be no change produced by setting the Attack Time Offset to a positive value. The same applies to the TVF envelope.

Part Release Time Offset

Adjusts the TVA/TVF Envelope Release Time for the patch or rhythm set assigned to a part.

Value: -64+ +63

NOTE

Patches also contain a Release Time Offset setting (p. 62). The final TVA Envelope release time value is therefore the sum of the tone’s TVA Envelope Time 4 setting, the patch’s Release Time Offset, and the part’s Release Time Offset. If the tone’s Time 4 parameter is set to “127” (maximum), there will be no change in the Release Time Offset, even when this is set to a positive value. The same applies to the TVF envelope.

Part Decay Time Offset

Adjusts the TVA/TVF Envelope Decay Time for the patch or rhythm set assigned to a part.

Value: -64+ +63

[F5 (Key Range)]

Part View								[New Song]	[M=0001]	STOP
Patch Name	KB	Range	Vel	Vibrato	Voice					
1 Alpha Retro	<input type="checkbox"/>	C-15 9	0	0	0	0				
2 Kickin' Bass	<input type="checkbox"/>	C-15 9	0	0	0	0				
3 Brisk Vortex	<input type="checkbox"/>	C-15 9	0	0	0	0				
4 WaitnOutside	<input type="checkbox"/>	C-15 9	0	0	0	0				
5 So true...	<input type="checkbox"/>	C-15 9	0	0	0	0				
6 So true...	<input type="checkbox"/>	C-15 9	0	0	0	0				
7 So true...	<input type="checkbox"/>	C-15 9	0	0	0	0				
8 So true...	<input type="checkbox"/>	C-15 9	0	0	0	0				
9 So true...	<input type="checkbox"/>	C-15 9	0	0	0	0				
10 ArtificialKit	<input type="checkbox"/>	C-15 9	0	0	0	0				
11 So true...	<input type="checkbox"/>	C-15 9	0	0	0	0				
12 So true...	<input type="checkbox"/>	C-15 9	0	0	0	0				
13 So true...	<input type="checkbox"/>	C-15 9	0	0	0	0				
14 So true...	<input type="checkbox"/>	C-15 9	0	0	0	0				
15 So true...	<input type="checkbox"/>	C-15 9	0	0	0	0				
16 So true...	<input type="checkbox"/>	C-15 9	0	0	0	0				

Keyboard Switch

Level	Output	Pitch	Offset	Key	Scale	Exter-	MIDI
Pan	Effect			Range	Tune	nal	Filter

cf.

For details on these settings, refer to “Adjusting the Parameters of Each Part” (p. 107).

Specifies whether the controller (keyboard) section will be connected to the internal sound generator and MIDI OUT regardless of the current part. Normally, you will leave this off, but you can turn it on if you want to layer sounds.

Value: ON, OFF

Keyboard Switch

Specifies, for each part, whether or not the keyboard controller section will be connected to the internal sound generator.

Value: On, OFF

Keyboard Range Lower (Part Keyboard Range Lower)

Specifies the lowest note that the tone will sound for each part.

Value: C-1-UPPER

Keyboard Range Upper (Part Keyboard Range Upper)

Specifies the highest note that the tone will sound for each part.

Value: LOWER–G9

NOTE

When the Key Range (p. 65) is set for each individual tone in a patch, sounds are produced in the range where the Key Range of each tone and the Key Range for the part overlap.

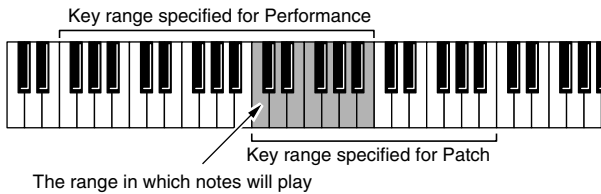

NOTE

If you attempt to raise the lower key higher than the upper key, or to lower the upper key below the lower key, the other value will be automatically modified to the same setting.

Part Velocity Sensitivity Offset

This changes the volume and cutoff frequency for each part according to the velocity with which the keys are pressed. If you want strongly played notes to raise the volume/cutoff frequency, set this parameter to positive (+) settings. If you want strongly played notes to lower the volume/cutoff frequency, use negative (-) settings. Set Velocity Sensitivity to “0” when you want sounds played at a fixed volume and cutoff frequency, regardless of the force with which the keys are played.

Value: -63– +63

NOTE

Patches also contain a Velocity Sensitivity Offset setting (p. 62). The ultimate Velocity Sensitivity Offset value is the sum of the part’s and the patch’s Velocity Sensitivity Offsets. Accordingly, if the patch’s Velocity Sensitivity Offset parameter is set to “127” (maximum), there will be no change in the part’s Velocity Sensitivity Offset, even when this is set to a positive value.

Part Vibrato Rate

For each part, adjust the vibrato speed (the rate at which the pitch is modulated). The pitch will be modulated more rapidly for higher settings, and more slowly with lower settings.

Value: -64– +63

Part Vibrato Depth

For each part, this adjusts the depth of the vibrato effect (the depth at which the pitch is modulated). The pitch will be modulated more greatly for higher settings, and less with lower settings.

Value: -64– +63

Part Vibrato Delay

For each part, this adjusts the time delay until the vibrato (pitch modulation) effect begins. Higher settings will produce a longer delay time before vibrato begins, while lower settings produce a shorter time.

Value: -64– +63

Voice Reserve

This setting specifies the number of voices that will be reserved for each part when more than 128 voices are played simultaneously.

Value: 0–63, FUL

NOTE

It is not possible for the settings of all parts to total an amount greater than 128. The remaining number of available voices will be displayed at (rest=). Pay attention to this readout as you make Voice Reserve settings.

Calculating the Number of Voices Being Used

The Fantom-X is able to play up to 128 notes simultaneously. The polyphony, or the number of voices (sounds) does not refer only to the number of sounds actually being played, but changes according to the number of tones used in the patches, and the number of Waves used in the tones. The following method is used to calculate the number of sounds used for one patch being played.

(Number of Sounds Being Played) x (Number of Tones Used by Patches Being Played) x (Number of Waves Used in the Tones)
Realtime Stretch requires twice the normal polyphony.

[F6 (Scale Tune)]

Part View		[New Song] M=0001 STOP										
	C	C#	D	Eb	E	F	F#	G	G#	A	Bb	B
1	0	0	0	0	0	0	0	0	0	0	0	0
2	0	0	0	0	0	0	0	0	0	0	0	0
3	0	0	0	0	0	0	0	0	0	0	0	0
4	0	0	0	0	0	0	0	0	0	0	0	0
5	0	0	0	0	0	0	0	0	0	0	0	0
6	0	0	0	0	0	0	0	0	0	0	0	0
7	0	0	0	0	0	0	0	0	0	0	0	0
8	0	0	0	0	0	0	0	0	0	0	0	0
9	0	0	0	0	0	0	0	0	0	0	0	0
10	0	0	0	0	0	0	0	0	0	0	0	0
11	0	0	0	0	0	0	0	0	0	0	0	0
12	0	0	0	0	0	0	0	0	0	0	0	0
13	0	0	0	0	0	0	0	0	0	0	0	0
14	0	0	0	0	0	0	0	0	0	0	0	0
15	0	0	0	0	0	0	0	0	0	0	0	0
16	0	0	0	0	0	0	0	0	0	0	0	0

Part Scale Tune for C

Level	Output	Pitch	Offset	Key	Scale	Exter-	MIDI
Pan	Effect			Range	Tune	nal	Filter

cf.

For details on these settings, refer to “Adjusting the Parameters of Each Part” (p. 107).

Part Scale Tune C–B

Make scale tune settings for each part.

Value: -64– +63

cf.

Scale Tune is switched on/off by means of the Scale Tune Switch parameter (p. 232).

Creating a Performance

Equal Temperament

This tuning divides the octave into 12 equal parts, and is the most widely used method of temperament used in Western music. The Fantom-X employs equal temperament when the Scale Tune Switch is set to "OFF."

Just Temperament (Tonic of C)

Compared with equal temperament, the principle triads sound pure in this tuning. However, this effect is achieved only in one key, and the triads will become ambiguous if you transpose.

Arabian Scale

In this scale, E and B are a quarter note lower and C#, F# and G# are a quarter-note higher compared to equal temperament. The intervals between G and B, C and E, F and G#, Bb and C#, and Eb and F# have a natural third—the interval between a major third and a minor third. On the Fantom-X, you can use Arabian temperament in the three keys of G, C and F.

<Example>

Note name	Equal temperament	Just Temperament (tonic C)	Arabian Scale
C	0	0	-6
C#	0	-8	+45
D	0	+4	-2
Eb	0	+16	-12
E	0	-14	-51
F	0	-2	-8
F#	0	-10	+43
G	0	+2	-4
G#	0	+14	+47
A	0	-16	0
Bb	0	+14	-10
B	0	-12	-49

[F7 (External)]

Patch Name	Rx Ch	Bank Sel	Prog	Ext Level	Ext Pan
1 Alpha Retro	1	OFF	0	OFF	OFF
2 Kickin' Bass	2	OFF	0	OFF	OFF
3 Bristk Vortex	3	OFF	0	OFF	OFF
4 WaitnOutside	4	OFF	0	OFF	OFF
5 So true...	5	OFF	0	OFF	OFF
6 So true...	6	OFF	0	OFF	OFF
7 So true...	7	OFF	0	OFF	OFF
8 So true...	8	OFF	0	OFF	OFF
9 So true...	9	OFF	0	OFF	OFF
10 ArtificialKit	10	OFF	0	OFF	OFF
11 So true...	11	OFF	0	OFF	OFF
12 So true...	12	OFF	0	OFF	OFF
13 So true...	13	OFF	0	OFF	OFF
14 So true...	14	OFF	0	OFF	OFF
15 So true...	15	OFF	0	OFF	OFF
16 So true...	16	OFF	0	OFF	OFF
Receive Switch					

cf. →

For details on these settings, refer to "Adjusting the Parameters of Each Part" (p. 107).

Receive Switch

For each part, specify whether MIDI messages will be received (ON), or not (OFF).

If this is "OFF," the part will not respond. Normally, you should leave this "ON," but you can turn it "OFF" when you do not want a specific part to be playing during song playback.

Value: OFF, ON

Receive Channel

Specifies the MIDI receive channel for each part

Value: 1–16

Ext Bank Select MSB (External Bank Select MSB)

If you want a Bank Select number MSB (controller number 0) to also be transmitted when you switch Performances, specify the value that you want to transmit (0–127) for each part. If you do not want this message to be transmitted, set this to "OFF."

Value: 0–127, OFF

NOTE

The data of the part for which the Keyboard Switch is turned off will not be transmitted.

Ext Bank Select LSB (External Bank Select LSB)

If you want a Bank Select number LSB (controller number 32) to also be transmitted when you switch Performances, specify the value that you want to transmit (0–127) for each part.

Value: 0–127

NOTE

The data of the part for which the Keyboard Switch is turned off will not be transmitted.

Ext Program Number (External Program Change Number)

If you want a Program Change number to also be transmitted when you switch Performances, specify the value that you want to transmit (0–128) for each part. If you do not want this message to be transmitted, set this to "OFF."

Value: 1–128, OFF

NOTE

The data of the part for which the Keyboard Switch is turned off will not be transmitted.

Ext Level (External Level)

If you want Volume messages to also be transmitted when you select a Performance, specify the desired value (0–127) for the part. If you do not want this message to be transmitted, set this to "OFF."

Value: 0–127, OFF

NOTE

The data of the part for which the Keyboard Switch is turned off will not be transmitted.

Ext Pan (External Pan)

If you want Pan messages to also be transmitted when you select a Performance, specify the desired value (L64–0–63R) for the part. If you do not want this message to be transmitted, set this to “OFF.”

Value: L64–0–63R, OFF

NOTE

These messages will not be transmitted by parts whose Keyboard Switch is turned off.

[F8 (MIDI Filter)]

Patch Name	Ch	PCBS	BP	PR	CB	MD	Vol	Ex	HD	Phase	Curve
1 Ripna Retro	1	<input checked="" type="checkbox"/>	<input checked="" type="checkbox"/>	<input checked="" type="checkbox"/>	<input checked="" type="checkbox"/>	<input checked="" type="checkbox"/>	<input checked="" type="checkbox"/>	<input checked="" type="checkbox"/>	<input checked="" type="checkbox"/>	<input checked="" type="checkbox"/>	OFF
2 Kickin' Bass	2	<input checked="" type="checkbox"/>	<input checked="" type="checkbox"/>	<input checked="" type="checkbox"/>	<input checked="" type="checkbox"/>	<input checked="" type="checkbox"/>	<input checked="" type="checkbox"/>	<input checked="" type="checkbox"/>	<input checked="" type="checkbox"/>	<input checked="" type="checkbox"/>	OFF
3 Brisk Vortex	3	<input checked="" type="checkbox"/>	<input checked="" type="checkbox"/>	<input checked="" type="checkbox"/>	<input checked="" type="checkbox"/>	<input checked="" type="checkbox"/>	<input checked="" type="checkbox"/>	<input checked="" type="checkbox"/>	<input checked="" type="checkbox"/>	<input checked="" type="checkbox"/>	OFF
4 WaitnOutside	4	<input checked="" type="checkbox"/>	<input checked="" type="checkbox"/>	<input checked="" type="checkbox"/>	<input checked="" type="checkbox"/>	<input checked="" type="checkbox"/>	<input checked="" type="checkbox"/>	<input checked="" type="checkbox"/>	<input checked="" type="checkbox"/>	<input checked="" type="checkbox"/>	OFF
5 So true...	5	<input checked="" type="checkbox"/>	<input checked="" type="checkbox"/>	<input checked="" type="checkbox"/>	<input checked="" type="checkbox"/>	<input checked="" type="checkbox"/>	<input checked="" type="checkbox"/>	<input checked="" type="checkbox"/>	<input checked="" type="checkbox"/>	<input checked="" type="checkbox"/>	OFF
6 So true...	6	<input checked="" type="checkbox"/>	<input checked="" type="checkbox"/>	<input checked="" type="checkbox"/>	<input checked="" type="checkbox"/>	<input checked="" type="checkbox"/>	<input checked="" type="checkbox"/>	<input checked="" type="checkbox"/>	<input checked="" type="checkbox"/>	<input checked="" type="checkbox"/>	OFF
7 So true...	7	<input checked="" type="checkbox"/>	<input checked="" type="checkbox"/>	<input checked="" type="checkbox"/>	<input checked="" type="checkbox"/>	<input checked="" type="checkbox"/>	<input checked="" type="checkbox"/>	<input checked="" type="checkbox"/>	<input checked="" type="checkbox"/>	<input checked="" type="checkbox"/>	OFF
8 So true...	8	<input checked="" type="checkbox"/>	<input checked="" type="checkbox"/>	<input checked="" type="checkbox"/>	<input checked="" type="checkbox"/>	<input checked="" type="checkbox"/>	<input checked="" type="checkbox"/>	<input checked="" type="checkbox"/>	<input checked="" type="checkbox"/>	<input checked="" type="checkbox"/>	OFF
9 So true...	9	<input checked="" type="checkbox"/>	<input checked="" type="checkbox"/>	<input checked="" type="checkbox"/>	<input checked="" type="checkbox"/>	<input checked="" type="checkbox"/>	<input checked="" type="checkbox"/>	<input checked="" type="checkbox"/>	<input checked="" type="checkbox"/>	<input checked="" type="checkbox"/>	OFF
10 Artificial Kit	10	<input checked="" type="checkbox"/>	<input checked="" type="checkbox"/>	<input checked="" type="checkbox"/>	<input checked="" type="checkbox"/>	<input checked="" type="checkbox"/>	<input checked="" type="checkbox"/>	<input checked="" type="checkbox"/>	<input checked="" type="checkbox"/>	<input checked="" type="checkbox"/>	OFF
11 So true...	11	<input checked="" type="checkbox"/>	<input checked="" type="checkbox"/>	<input checked="" type="checkbox"/>	<input checked="" type="checkbox"/>	<input checked="" type="checkbox"/>	<input checked="" type="checkbox"/>	<input checked="" type="checkbox"/>	<input checked="" type="checkbox"/>	<input checked="" type="checkbox"/>	OFF
12 So true...	12	<input checked="" type="checkbox"/>	<input checked="" type="checkbox"/>	<input checked="" type="checkbox"/>	<input checked="" type="checkbox"/>	<input checked="" type="checkbox"/>	<input checked="" type="checkbox"/>	<input checked="" type="checkbox"/>	<input checked="" type="checkbox"/>	<input checked="" type="checkbox"/>	OFF
13 So true...	13	<input checked="" type="checkbox"/>	<input checked="" type="checkbox"/>	<input checked="" type="checkbox"/>	<input checked="" type="checkbox"/>	<input checked="" type="checkbox"/>	<input checked="" type="checkbox"/>	<input checked="" type="checkbox"/>	<input checked="" type="checkbox"/>	<input checked="" type="checkbox"/>	OFF
14 So true...	14	<input checked="" type="checkbox"/>	<input checked="" type="checkbox"/>	<input checked="" type="checkbox"/>	<input checked="" type="checkbox"/>	<input checked="" type="checkbox"/>	<input checked="" type="checkbox"/>	<input checked="" type="checkbox"/>	<input checked="" type="checkbox"/>	<input checked="" type="checkbox"/>	OFF
15 So true...	15	<input checked="" type="checkbox"/>	<input checked="" type="checkbox"/>	<input checked="" type="checkbox"/>	<input checked="" type="checkbox"/>	<input checked="" type="checkbox"/>	<input checked="" type="checkbox"/>	<input checked="" type="checkbox"/>	<input checked="" type="checkbox"/>	<input checked="" type="checkbox"/>	OFF
16 So true...	16	<input checked="" type="checkbox"/>	<input checked="" type="checkbox"/>	<input checked="" type="checkbox"/>	<input checked="" type="checkbox"/>	<input checked="" type="checkbox"/>	<input checked="" type="checkbox"/>	<input checked="" type="checkbox"/>	<input checked="" type="checkbox"/>	<input checked="" type="checkbox"/>	OFF

cf. →

For details on these settings, refer to “Adjusting the Parameters of Each Part” (p. 107).

MIDI Filter

Program Change (Receive Program Change Switch)

For each MIDI channel, specify whether MIDI Program Change messages will be received (ON), or not (OFF). Assigning a check mark (✓) will enable reception, and removing the check mark will disable reception.

Bank Select (Receive Bank Select Switch)

For each MIDI channel, specify whether MIDI Bank Select messages will be received (ON), or not (OFF). Assigning a check mark (✓) will enable reception, and removing the check mark will disable reception.

Pitch Bend (Receive Pitch Bend Switch)

For each MIDI channel, specify whether MIDI Pitch Bend messages will be received (ON), or not (OFF). Assigning a check mark (✓) will enable reception, and removing the check mark will disable reception.

Channel Pressure (Receive Channel Pressure Switch)

For each MIDI channel, specify whether MIDI Channel Pressure messages will be received (ON), or not (OFF). Assigning a check mark (✓) will enable reception, and removing the check mark will disable reception.

Polyphonic Key Pressure (Receive Polyphonic Key Pressure Switch)

For each MIDI channel, specify whether MIDI polyphonic key pressure messages will be received (ON), or not (OFF). Assigning a check mark (✓) will enable reception, and removing the check mark will disable reception.

Modulation (Receive Modulation Switch)

For each MIDI channel, specify whether MIDI Modulation messages will be received (ON), or not (OFF). Assigning a check mark (✓) will enable reception, and removing the check mark will disable reception.

Volume (Receive Volume Switch)

For each MIDI channel, specify whether MIDI Volume messages will be received (ON), or not (OFF). Assigning a check mark (✓) will enable reception, and removing the check mark will disable reception.

Pan (Receive Pan Switch)

For each MIDI channel, specify whether MIDI Pan messages will be received (ON), or not (OFF). Assigning a check mark (✓) will enable reception, and removing the check mark will disable reception.

Expression (Receive Expression Switch)

For each MIDI channel, specify whether MIDI Expression messages will be received (ON), or not (OFF). Assigning a check mark (✓) will enable reception, and removing the check mark will disable reception.

Hold-1 (Receive Hold 1 Switch)

For each MIDI channel, specify whether MIDI Hold 1 messages will be received (ON), or not (OFF). Assigning a check mark (✓) will enable reception, and removing the check mark will disable reception.

Phase Lock (Phase Lock Switch)

Set Phase Lock to “✓” (ON) when you want to suppress discrepancies in timing of parts played on the same MIDI channel.

NOTE

When the Phase Lock parameter is set to “ON,” parts on the same MIDI channel are put in a condition in which their timing is matched, enabling them to be played at the same time. Accordingly, a certain amount of time may elapse between reception of the Note messages and playing of the sounds. Turn this setting to “ON” only as needed.

Velocity Curve

Velocity Curve selects for each MIDI channel one of the four following Velocity Curve types that best matches the touch of the connected MIDI keyboard. Set this to “OFF” if you are using the MIDI keyboard’s own velocity curve.

Value: OFF, 1–4

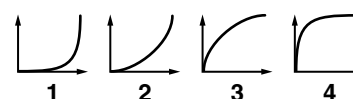

Selecting the Parameter Controlled by the Realtime Controllers or D Beam Controller (Control Setting)

The Fantom-X lets you assign the parameters that will be affected when you operate the realtime control knobs, assignable switches, D Beam, pitch bend, or modulation lever. This lets you modify the sound in a variety of ways by operating the controllers.

1. Access the Performance Layer or Mixer screen, and select the Performance whose settings you wish to modify (p. 99).

TIP

If you want to create a performance from scratch (rather than starting from an existing performance), execute the **Initialize** operation (p. 119).

2. Press [F4 (Ctrl Setting)].

The Control Setting (Performance) screen appears.



3. The parameters are organized into several editing groups. Press [F1 (↑)] [F2 (↓)] to select the tab for the editing group that contains the parameter you wish to edit.
4. Use [CURSOR] to move the cursor to the parameter you wish to modify.
5. Turn the VALUE dial or press [INC]/[DEC] to get the value you want.
6. Repeat steps 3-5 to set each parameter you want to edit.
7. The settings for the Solo Synth are saved for the system settings. Press [F8 (System Write)] to execute the write operation.
8. The settings in the Control Setting screen are saved independently for each performance. If you wish to save the changes you've made, press [WRITE] to perform the Save operation (p. 120). If you do not wish to save changes, press [EXIT] to return to the Performance Layer or Mixer screen.

If you return to the Performance PLAY screen without saving, the display will indicate "*"," reminding you that the Performance settings have been modified.

NOTE

If you turn off the power or select a different sound while the display indicates "*"," your edited Performance will be lost.

Make Settings for the Realtime Controllers and D Beam Controller (Ctrl)



For details on these settings, refer to "Selecting the Parameter Controlled by the Realtime Controllers or D Beam Controller (Control Setting)" (p. 114).

D Beam (Pad Trigger)

Instead of striking the pads themselves, you can also use the D Beam controller to control the sounding of the pads.

TIP

PAD trigger settings are saved independently for each performance as part of the performance settings. This lets you create performances that make effective use of controller settings.

Pad Number

Specifies the pad number affected by the D Beam.

Value: 1-16

Pad Velocity

Specifies the strength of the pad sound played by the D Beam controller.

Value: 1-127

Pad Control Mode

This specifies how the D Beam will behave when it is obstructed. If this is set to MOMENTARY, the parameter will be on only while the D Beam is obstructed, and will turn off when you stop obstructing it. If this is set to LATCH, the parameter will alternately be switched on/off each time you obstruct the D Beam.

Value: MOMENTARY, LATCH

D Beam (Solo Synth)

You can use the D Beam controller to perform in a way similar to on a mono synth.



cf. →

For details on these settings, refer to “**Selecting the Parameter Controlled by the Realtime Controllers or D Beam Controller (Control Setting)**” (p. 114).

TIP

When you press [F7 (Panel View)], the Panel View screen will appear, which displays the above parameters in graphical fashion, simulating an analog synthesizer. From the Panel View screen, you can press [F2 (Image View)] to open the Image View screen, where you can see a graphical indication of the D Beam output value. Press [EXIT] to leave this screen. To exit from this screen, press [EXIT].

TIP

Settings for the Solo Synth are saved for system settings.

OSC 1/2 Waveform

Select the waveform. **SAW** is a sawtooth wave, and **SQR** is a square wave.

OSC 1/2 Pulse Width

Specifies the pulse width of the waveform. By cyclically modifying the pulse width you can create subtle changes in the tone.

* The Pulse Width is activated when “SQR” is selected with OSC1/2 waveform.

Value: 0–127

OSC 1/2 Coarse Tune

Adjusts the pitch of the tone’s sound up or down in semitone steps (+/-4 octaves).

Value: -48–+48

OSC 1/2 Fine Tune

Adjusts the pitch of the tone’s sound up or down in 1-cent steps (+/-50 cents).

Value: -50–+50

OSC2 Level

Adjust the level.

Value: 0–127

OSC1 Sync Switch

Turning this switch on produces a complex sound with many harmonics. This is effective when the OSC1 pitch is higher than the OSC2 pitch.

Value: OFF, ON

Filter Type

Selects the type of filter.

OFF: No filter is used.

LPF: Low Pass Filter. This reduces the volume of all frequencies above the cutoff frequency (Cutoff Freq) in order to round off, or un-brighten the sound. This is the most common filter used in synthesizers.

BPF: Band Pass Filter. This leaves only the frequencies in the region of the cutoff frequency, and cuts the rest. This can be useful when creating distinctive sounds.

HPF: High Pass Filter. This cuts the frequencies in the region below the cutoff frequency. This is suitable for creating percussive sounds emphasizing their higher tones.

PKG: Peaking Filter. This emphasizes the frequencies in the region of the cutoff frequency. You can use this to create wah-wah effects by employing an LFO to change the cutoff frequency cyclically.

Cutoff

Selects the frequency at which the filter begins to have an effect on the waveform’s frequency components.

Value: 0–127

Resonance

Emphasizes the portion of the sound in the region of the cutoff frequency, adding character to the sound. Excessively high settings can produce oscillation, causing the sound to distort.

Value: 0–127

Level

Sets the volume.

Value: 0–127

Chorus Send Level

Sets the level of the signal sent to chorus.

Value: 0–127

Reverb Send Level

Sets the level of the signal sent to reverb.

Value: 0–127

LFO Rate

Adjusts the modulation rate, or speed, of the LFO.

Value: 0–127

LFO Osc 1 Pitch Depth

Specifies the depth to which the LFO will modulate the OSC1 pitch.

Value: -63–+63

LFO Osc 2 Pitch Depth

Specifies the depth to which the LFO will modulate the OSC2 pitch.

Value: -63+63

LFO Osc 1 Pulse Width Depth

Specifies the depth to which the LFO will modulate the pulse width of the OSC1 waveform.

* *The Pulse Width is activated when "SQR" is selected with OSC1/2 waveform.*

Value: -63+63

LFO Osc 2 Pulse Width Depth

Specifies the depth to which the LFO will modulate the pulse width of the OSC2 waveform.

* *The Pulse Width is activated when "SQR" is selected with OSC1/2 waveform.*

Value: -63+63

Range (Solo synth range)

Specifies the range in which the pitch of the solo synth will vary.

Value: 2 OCTAVES, 4 OCTAVES, 8 OCTAVES

D Beam (Assignable)

By assigning a variety of functions to the D Beam controller you can apply different effects to the sound in real time.



cf.

For details on these settings, refer to “**Selecting the Parameter Controlled by the Realtime Controllers or D Beam Controller (Control Setting)**” (p. 114).

TIP

The settings for the ASSIGNABLE are saved independently for each performance as part of the performance settings. This lets you create performances that make effective use of controller settings.

Type (Assignable Type)

Specifies the function controlled by the D Beam controller.

Value

CC01–31, 33–95: Controller numbers 1–31, 33–95

cf.

For more information about Control Change messages, please refer to “**MIDI Implementation**” (p. 298).

- Bend Up:** Controls the pitch as specified by the “Pitch Bend Range Up” setting (p. 67).
- Bend Down:** Controls the pitch as specified by the “Pitch Bend Range Down” setting (p. 67).
- Start/Stop:** Starts/Stops the sequencer.
- TAP Tempo:** Tap tempo (a tempo specified by the interval at which you move your hand over the D Beam controller).
- Arp Grid:** Arpeggio Grid
- Arp Duration:** Adjusts the duration of each arpeggiated note
- Arp Motif:** Arpeggio Motif
- Arp Oct Up:** The range in which the arpeggio is sounded will rise in steps of an octave (maximum 3 octaves).
- Arp Oct Down:** The range in which the arpeggio is sounded will lower in steps of an octave (maximum 3 octaves).

Range Min (D Beam Range Lower)

Specify the lower limit of the range of the D Beam controller.

Value: 0–127

Range Max (D Beam Range Upper)

Specify the upper limit of the range of the D Beam controller. By setting Range Max below Range Min you can invert the range of change.

Value: 0–127

Knob



cf. →

For details on these settings, refer to “**Selecting the Parameter Controlled by the Realtime Controllers or D Beam Controller (Control Setting)**” (p. 114).

NOTE

Knob parameters are valid only when the REALTIME CONTROL button is set to “ASSIGNABLE.”

Knob Assign 1-4 (Realtime Control Knob Assign 1-4)

Specify the functions that will be controlled by the [] knobs.

Value

CC01-31, 33-95: Controller numbers 1-31, 33-95

cf. →

For more information about Control Change messages, please refer to “**MIDI Implementation**” (p. 298).

- Pitch Bend:** Pitch Bend
- Aftertouch:** Aftertouch
- Arp Style:** Arpeggio Style
- Arp Grid:** Arpeggio Grid
- Arp Duration:** Adjusts the duration of each arpeggiated note
- Arp Motif:** Arpeggio Motif
- Chord Form:** Chord form of the Chord Memory function
- Master Level:** The volume of the entire Fantom-X
 - * *Master Level adjusts the volume both of the OUTPUT A jacks and the DIGITAL OUT jack. The panel VOLUME knob only adjusts the volume of the OUTPUT A jacks.*
- Arp Step:** Controls the playback position of the arpeggio pattern.
- Digital In:** Input level from DIGITAL IN.

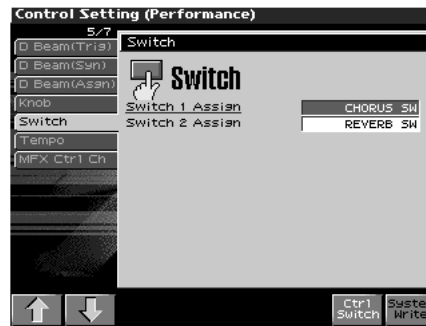

Switch



cf. →

For details on these settings, refer to “**Selecting the Parameter Controlled by the Realtime Controllers or D Beam Controller (Control Setting)**” (p. 114).

Switch 1/2 (Assignable Switch 1-2)

Specify the functions that will be controlled by the []/[] buttons.

Value

- Transpose Down:** Lowers the key range in semitone steps (up to 5 semitones lower).
- Transpose Up:** Raises the key range in semitone steps (up to 6 semitones higher).
- Tap Tempo:** Tap tempo (a tempo specified by the interval at which you press the button).
- Mono/poly:** Pressed to toggle between polyphonic (POLY) and monophonic (MONO) play of a patch.
- Portamento:** Portamento On/Off
- Hold:** Hold play On/Off
- MFX1-3 Sw:** Multi-effect 1-3 switch
- Chorus Sw:** Chorus switch
- Reverb Sw:** Reverb switch
- Mastering Sw:** Mastering switch
- Loop:** Loop play On/Off
- Rhythm Start/Stop:** Rhythm pattern playback On/Off

Tempo



cf. →

For details on these settings, refer to “**Selecting the Parameter Controlled by the Realtime Controllers or D Beam Controller (Control Setting)**” (p. 114).

Recommended Tempo

If you want the sequencer tempo to change when you switch Performances, specify the tempo that will follow this change. This setting is valid when the Seq Tempo Override parameter is “ON.” In order to enable this setting, turn on the Tempo Override parameter (p. 227).

Value: 20–250

- * This value is specified independently for each performance. This means that when you switch performances, the tempo setting of the Fantom-X will change.
- * The sequencer tempo will be overwritten to the new tempo when you switch performances.

MFX Ctrl Ch

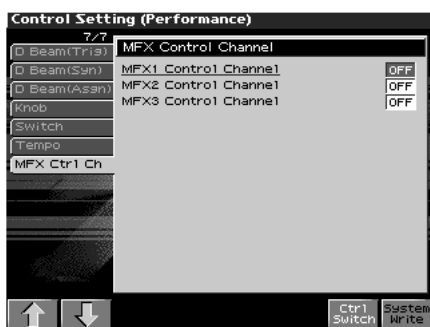

cf. →

For details on these settings, refer to “**Selecting the Parameter Controlled by the Realtime Controllers or D Beam Controller (Control Setting)**” (p. 114).

MFX 1–3 Control Channel

Select the channel to which the multi-effect will be applied. Control to modify multi-effects parameters in realtime, when MFX1–3 Source parameter is set to “Prf.” Set to “OFF” when the Multi-effects Control is not being used.

Value: 1–16, OFF

Control Switch Settings (Ctrl Switch)

You can change controller switch on/off settings for each patch in the performance.

1. In the Control Setting (Performance) screen, press [F7 (Ctrl Switch)].

Patch Name	P.B.	Aft	Mod	HoldCtrl	Beam	Knob1-4
1 Alpha Retro	✓	✓	✓	✓	✓	✓
2 Kickin' Bass	✓	✓	✓	✓	✓	✓
3 Brisk Vortex	✓	✓	✓	✓	✓	✓
4 WaitnOutside	✓	✓	✓	✓	✓	✓
5 So true...	✓	✓	✓	✓	✓	✓
6 So true...	✓	✓	✓	✓	✓	✓
7 So true...	✓	✓	✓	✓	✓	✓
8 So true...	✓	✓	✓	✓	✓	✓
9 So true...	✓	✓	✓	✓	✓	✓
10 ArtificialKit	✓	✓	✓	✓	✓	✓
11 So true...	✓	✓	✓	✓	✓	✓
12 So true...	✓	✓	✓	✓	✓	✓
13 So true...	✓	✓	✓	✓	✓	✓
14 So true...	✓	✓	✓	✓	✓	✓
15 So true...	✓	✓	✓	✓	✓	✓
16 So true...	✓	✓	✓	✓	✓	✓

2. Use [CURSOR] to move the cursor to the parameter you wish to modify.
3. Turn the VALUE dial or press [INC]/[DEC] to get the value you want.
4. Repeat steps 2-3 to set each parameter you want to edit.
5. Press [F8 (EXIT)] to return to the previous screen.

Control Bender (Control Pitch Bend Switch)

For each part, specify whether MIDI Pitch Bend messages will be transmitted (ON), or not (OFF).

Value: OFF, ON

Control Aftertouch (Control Aftertouch Switch)

For each part, specify whether MIDI Aftertouch messages will be transmitted (ON), or not (OFF).

Value: OFF, ON

Control Modulation (Control Modulation Switch)

For each part, specify whether MIDI Modulation messages will be transmitted (ON), or not (OFF).

Value: OFF, ON

Control Hold Pedal (Control Hold Pedal Switch)

For each part, you can specify whether control messages from a pedal connected to the HOLD PEDAL jacks will be transmitted (ON), or not (OFF).

Value: OFF, ON

Control Pedal (Control Pedal Switch)

For each part, you can specify whether control messages from a pedal connected to the CONTROL PEDAL jacks will be transmitted (ON), or not (OFF).

Value: OFF, ON

Control D Beam (Control D Beam Switch)

Specifies whether each part will be controlled by the D Beam.

Value: OFF, ON

Control Knob (Control Knob Switch)

Specifies whether each part will be controlled by the control knob.

Value: OFF, ON

Changing the Settings of the Patch Assigned to a Part

When using patches in Performance mode, some settings such as effects settings will be affected by Performance settings. If you wish to edit a patch while hearing how it will sound in the Performance, use this procedure:

* Here we explain how to change the setting of a patch assigned to a part. The procedure for changing the settings of rhythm sets is the same. Substitute "rhythm set" wherever "patch" appears in a sentence.

1. Make sure the Performance mode is selected.
2. Press [PATCH EDIT].

The patch assigned to the part is displayed in the Patch Edit screen.



3. The rest of the procedure is the same as when making changes in Patch mode (p. 56).

Initializing Performance Settings (Init)

"Initialize" means to return the settings of the currently selected sound to a standard set of values.

NOTE

The Initialize operation will affect only the currently selected sound; the sounds that are stored in user memory will not be affected. If you wish to restore all of the Fantom-X's settings to their factory values, perform a Factory Reset (p. 235).

1. Select the Performance that you wish to initialize (p. 99).
2. Hold down [SHIFT] and press [F1 (Init)].
The Performance Initialize window will appear.
3. Turn the VALUE dial or press ▲ or ▼ to select the initialization type.
 - **DEFAULT:** Resets the currently selected performance in the Temporary memory to the standard values. Use this setting when you wish to create a sound from scratch.
 - **SOUND CONTROL:** Initializes the values of the following part parameters. Cutoff Offset, Resonance Offset, Attack Time Offset, Release Time Offset, Decay Time Offset, Vibrato Rate, Vibrato, Depth, Vibrato Delay
4. Press [F8 (Select)].
A message will ask you for confirmation.
5. Press [F8 (Exec)].
The initialization will be carried out, and you'll be returned to the previous screen.
To cancel, press [F7 (Cancel)].

Saving a Performance You've Created (Write)

Changes you make to sound settings are temporary, and will be lost if you turn off the power or select another sound. If you want to keep the modified sound, you must save it in the User area or a memory card.

When you modify the settings of a Performance, the Performance Layer screen will indicate "*". Once you save the Performance into user area, the "*" indication goes away.

NOTE

When you perform the save procedure, the data that previously occupied the save destination will be lost.

1. **Make sure that the performance you wish to save is selected.**

2. **Press [WRITE].**

The Write Menu screen appears.

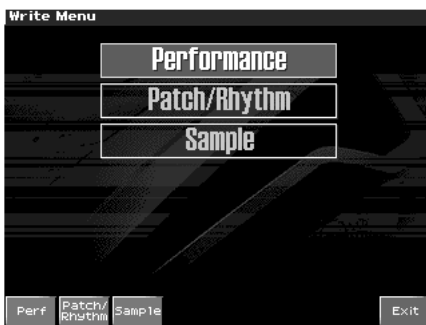

3. **Press [F1 (Perf)].**

* Alternatively, you can use CURSOR ▲ or ▼ to select "Performance," and then press [ENTER].

The Performance Write screen appears.



4. **Assign a name to the performance.**



For details on assigning names, refer to "Assigning a Name" (p. 36)

5. **When you have finished inputting the name, press [F8 (Write)].**

A screen will appear, allowing you to select the write-destination performance.



6. **Press [F1 (↑)] or [F2 (↓)] to select the write destination. Then the VALUE dial or use [INC] [DEC] to select the performance number.**

The write destination can be either the Fantom-X's internal user area (User), or a memory card (Card).

7. **Press [F8 (Write)].**

A message will ask you for confirmation.

NOTE

Never switch off the Fantom-X while data is being saved.

8. **Press [F8 (Exec)] to execute the save operation.**

* To cancel the operation, press [F7 (Cancel)].

When Changing the Settings for the Patch or Rhythm Set Assigned to a Part in a Performance

If you've edited a patch or rhythm set assigned to a part in a performance and then try to save the performance without first saving the edited patch or rhythm set, the following message appears.

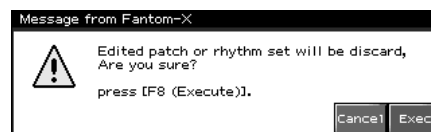

In such cases, first save the patches and rhythm sets, and then save the performance.

Modifying the Sound in Real Time

You can use the D Beam controller, realtime controllers, assignable switches or a pedal to modify the sound while you perform.

MEMO

Here we will explain the procedures and settings for using these functions in Patch mode. The operations are the same in Performance mode.

Waving Your Hand Over the D Beam to Modify the Sound (D Beam Controller)

The **D Beam controller** can be used simply by waving your hand over it. It can be used to apply various effects, depending on the function that is assigned to it. You can also create effects in which the sound changes instantaneously, in a way that would not be possible by operating a knob or the bender lever. On the Fantom-X, the D Beam controller can be used not only to modify the sounds assigned to the Keyboard part or Pad part, but also to control the pitch of a monophonic (solo) synthesizer sound.

1. Access the Patch Play screen (p. 38).

The following area of the screen is the D Beam controller display area.

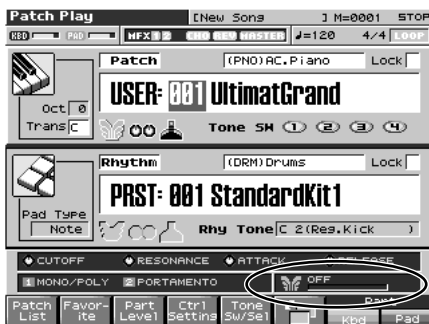

2. Press either the D BEAM [PAD TRIGGER], [SOLO SYNTH], or [ASSIGNABLE] button to turn on the D Beam controller.



- **ASSIGNABLE button:** Operates the function assigned to the D Beam controller.
- **PAD TRIGGER button:** Use the D Beam controller to play sounds instead of striking the pads.
- **SOLO SYNTH button:** Lets you use the D Beam as a monophonic synthesizer.

3. While you play the keyboard or pads to produce sound, place your hand above the D Beam controller and move it slowly up and down.

An effect will be applied to the sound, depending on the function that is assigned to the D Beam controller.

4. To turn off the D Beam controller, once again press the button you pressed in step 2 so the indicator goes out.

MEMO

If Performance mode is selected, the D Beam controller on/off setting is saved for each performance as part of the performance settings.

The usable range of the D Beam controller

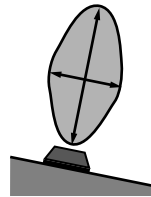

The following diagram shows the usable range of the D Beam controller. Waving your hand outside this range will produce no effect.

The response of the D Beam Controller can also be checked in the "D Beam" area of the display. This is displayed graphically as a bar that lengthens as you move your hand closer, and shortens as you move your hand away.



NOTE

The usable range of the D Beam controller will become extremely small when used under strong direct sunlight. Please be aware of this when using the D Beam controller outside.

NOTE

The sensitivity of the D Beam controller will change depending on the amount of light in the vicinity of the unit. If it does not function as you expect, adjust the sensitivity as appropriate for the brightness of your location. Increase this value will raise the sensitivity (p. 226).

Making Settings for the D Beam Controller

Assignable

You can assign various functions to the D Beam controller and apply a wide range of effects to the sound in real time.

1. Hold down [SHIFT] and press D BEAM [ASSIGNABLE].
The Assignable screen appears.



2. Move the cursor to the parameter that you want to set, and turn the VALUE dial or press [INC]/[DEC] to make the setting.
3. Press [EXIT] the Assignable screen will close.

Type

Specifies the function controlled by the D Beam controller.

Value

CC01–31, 33–95: Controller numbers 1–31, 33–95



For more information about Control Change messages, please refer to “MIDI Implementation” (p. 298).

- Bend Up:** Controls the pitch as specified by the “Pitch Bend Range Up” setting (p. 67).
- Bend Down:** Controls the pitch as specified by the “Pitch Bend Range Down” setting (p. 67).
- Start/stop:** Starts/Stops the sequencer.
- TAP Tempo:** Tap tempo (a tempo specified by the interval at which you move your hand over the D Beam controller).
- Arp Grid:** Arpeggio Grid
- Arp Duration:** Adjusts the duration of each arpeggiated note
- Arp Motif:** Arpeggio Motif
- Arp Oct Up:** The range in which the arpeggio is sounded will rise in steps of an octave (maximum 3 octaves).
- Arp Oct Down:** The range in which the arpeggio is sounded will lower in steps of an octave (maximum 3 octaves).
- Arp Step:** Controls the playback position of the arpeggio pattern.
- Aftertouch:** Aftertouch

Range Min (D Beam Range Lower)

Specify the lower limit of the range of the D Beam controller.

Value: 0–127

Range Max (D Beam Range Upper)

Specify the upper limit of the range of the D Beam controller. By setting Range Max below Range Min you can invert the range of change.

Value: 0–127



The settings for the ASSIGNABLE are saved independently for each performance as part of the performance settings. This lets you create performances that make effective use of controller settings.



If Patch mode is selected, this is saved as part of the system settings. If you want to save the settings, press [F8 (System Write)].

Pad Trigger (Pad-related settings)

You can use the D Beam controller to control the pads as an alternative to striking the pads themselves.

1. Hold down [SHIFT] and press D BEAM [PAD TRIGGER].
The Pad Trigger Screen appears.



2. Move the cursor to the parameter that you want to set, and turn the VALUE dial or press [INC]/[DEC] to make the setting.
3. Press [EXIT] the Pad Trigger screen will close.

Pad Number

Specifies the pad number affected by the D Beam.

When the cursor is located at this parameter, you can also make this setting by striking the desired pad.

Value: 0–16

Pad Velocity

Specifies the strength of the pad sound played by the D Beam controller.

Value: 1–127

Pad Control Mode

This specifies how the D Beam will behave when it is obstructed. If this is set to **MOMENTARY**, the parameter will be on only while the D Beam is obstructed, and will turn off when you stop obstructing it. If this is set to **LATCH**, the parameter will alternately be switched on/off each time you obstruct the D Beam.

Value: MOMENTARY, LATCH

TIP

PAD trigger settings are saved independently for each performance as part of the performance settings. This lets you create performances that make effective use of controller settings.

TIP

If Patch mode is selected, this is saved as part of the system settings. If you want to save the settings, press [F8 (System Write)].

Solo Synth

On the Fantom-X you can play a monophonic synthesizer whose pitch is controlled by the D Beam.

1. Hold down [SHIFT] and press D BEAM [SOLO SYNTH].

The Solo Synth screen appears.



TIP

When you press [F6 (Panel View)], the Panel View screen will appear, which displays the above parameters in graphical fashion, simulating an analog synthesizer. From the Panel View screen, you can press [F2 (Image View)] to open the Image View screen, where you can see a graphical indication of the D Beam output value. Press [EXIT] to return to the Control Setting screen.

2. Move the cursor to the parameter that you want to set, and turn the VALUE dial or press [INC]/[DEC] to make the setting.

3. If you want to save the settings, press [F8 (System Write)].

If you press [EXIT] the Assignable screen will close.

TIP

Setting for the Solo Synth are saved for system settings.

OSC 1/2 Waveform

Select the waveform. **SAW** is a sawtooth wave, and **SQR** is a square wave.

Value: SAW, SQR

OSC 1/2 Pulse Width

Specifies the pulse width of the waveform. By cyclically modifying the pulse width you can create subtle changes in the tone.

* The Pulse Width is activated when "SQR" is selected with OSC1/2 waveform.

Value: 0-127

OSC 1/2 Coarse Tune

Adjusts the pitch of the tone's sound up or down in semitone steps (+/-4 octaves).

Value: -48+48

OSC 1/2 Fine Tune

Adjusts the pitch of the tone's sound up or down in 1-cent steps (+/-50 cents).

Value: -50+50

OSC2 Level

Adjust the OSC2 level.

Value: 0-127

OSC1 Sync Switch

Turning this switch on produces a complex sound with many harmonics. This is effective when the OSC1 pitch is higher than the OSC2 pitch.

Value: OFF, ON

Filter Type

Selects the type of filter.

OFF: No filter is used.

LPF: Low Pass Filter. This reduces the volume of all frequencies above the cutoff frequency (Cutoff Freq) in order to round off, or un-brighten the sound. This is the most common filter used in synthesizers.

BPF: Band Pass Filter. This leaves only the frequencies in the region of the cutoff frequency, and cuts the rest. This can be useful when creating distinctive sounds.

HPF: High Pass Filter. This cuts the frequencies in the region below the cutoff frequency. This is suitable for creating percussive sounds emphasizing their higher tones.

PKG: Peaking Filter. This emphasizes the frequencies in the region of the cutoff frequency. You can use this to create wah-wah effects by employing an LFO to change the cutoff frequency cyclically.

Cutoff

Selects the frequency at which the filter begins to have an effect on the waveform's frequency components.

Value: 0-127

Modifying the Sound in Real Time

Resonance

Emphasizes the portion of the sound in the region of the cutoff frequency, adding character to the sound. Excessively high settings can produce oscillation, causing the sound to distort.

Value: 0–127

Level

Sets the volume.

Value: 0–127

Chorus Send Level

Sets the level of the signal sent to chorus.

Value: 0–127

Reverb Send Level

Sets the level of the signal sent to reverb.

Value: 0–127

LFO Rate

Adjusts the modulation rate, or speed, of the LFO.

Value: 0–127

LFO Osc 1 Pitch Depth

Specifies the depth to which the LFO will modulate the OSC1 pitch.

Value: -63–+63

LFO Osc 2 Pitch Depth

Specifies the depth to which the LFO will modulate the OSC2 pitch.

Value: -63–+63

LFO Osc 1 Pulse Width Depth

Specifies the depth to which the LFO will modulate the pulse width of the OSC1 waveform.

* The Pulse Width is activated when "SQR" is selected with OSC1/2 waveform.

Value: -63–+63

LFO Osc 2 Pulse Width Depth

Specifies the depth to which the LFO will modulate the pulse width of the OSC2 waveform.

* The Pulse Width is activated when "SQR" is selected with OSC1/2 waveform.

Value: -63–+63

Range (Solo synth range)



Specifies the range in which the pitch of the solo synth will vary.

Value: 2 OCTAVES, 4 OCTAVES, 8 OCTAVES

Using Knobs or Buttons to Modify the Sound (Realtime Controller)

You can use the REALTIME CONTROL knobs and ASSIGNABLE SW buttons to modify the sound in real time.

1. Access the Patch Play screen (p. 38).

The "Realtime Control" area shows the function that is assigned to each realtime controller knob and button. [] indicate the four knobs, and [], [] indicate the two buttons.

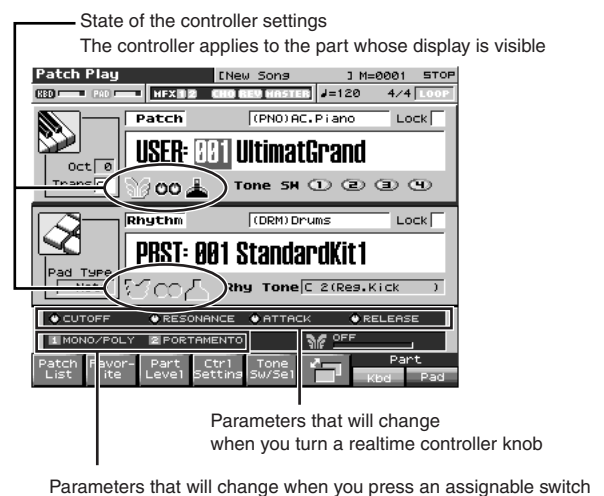

2. You can select the function of the knobs by pressing the button located at the right of the realtime control knobs. The parameter display at the bottom of the screen will also change.

- **If the FILTER/ENV indicator is lit**
Turning the knobs will control Cutoff, Resonance, Attack, and Release.
 - **If the ARP/RHY indicator is lit**
Turning the knobs will control the arpeggio parameters Range and Accent, and the rhythm parameters Accent Rate and Tempo.
 - **If the ASSIGNABLE indicator is lit**
Turning the knobs will control the assigned parameters. You can freely assign parameters.
- * If the indicators are unlit, turning the knobs will not control any parameters.

3. While playing the keyboard or pressing the pads to produce sound, operate the REALTIME CONTROL knobs and ASSIGNABLE SW buttons.

The sound will change according to the function assigned to each knob or button.

Changing Realtime Controller Settings

Realtime Controller Knob Settings

1. Hold down [SHIFT] and rotate one of the REALTIME CONTROL knobs.

The Knob screen appears.



2. Move the cursor to the parameter that you want to set, and turn the VALUE dial or press [INC]/[DEC] to set it.
3. If you want to save your settings, press [F8 (System Write)]. Press [Exit] to return to the previous screen.

TIP

Realtime controller settings are saved independently for each performance as part of the performance settings. This lets you create performances that make effective use of controller settings.

Knob Assign 1–4 (Realtime Control Knob Assign 1–4)

Specify the functions that will be controlled by the [] knobs.

Value

CC01–31, 33–95: Controller numbers 1–31, 33–95

cf.

For more information about Control Change messages, please refer to “MIDI Implementation” (p. 298).

PITCH BEND:	Pitch Bend
AFTERTOUCH:	Aftertouch
ARP STYLE:	Arpeggio Style
ARP GRID:	Arpeggio Grid
ARP DURATION:	Adjusts the duration of each arpeggiated note
ARP MOTIF:	Arpeggio Motif
CHORD FORM:	Chord form of the Chord Memory function
MASTER LEVEL:	The volume of the entire Fantom-X

* Master Level adjusts the volume both of the OUTPUT A jacks and the DIGITAL OUT jack. The panel VOLUME knob only adjusts the volume of the OUTPUT A jacks.

ARP STEP:	Controls the playback position of the arpeggio pattern.
DIGITAL IN:	Input level from DIGITAL IN.

Assignable Switch Settings

1. Hold down [SHIFT] and press one of the ASSIGNABLE SW button.

The Switch screen appears.

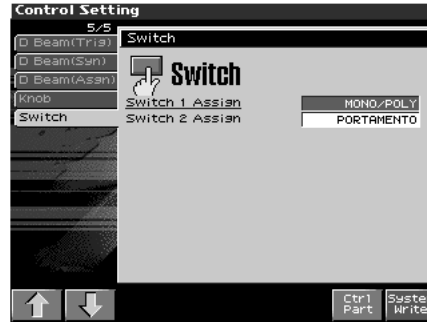

2. Move the cursor to the parameter that you want to set, and turn the VALUE dial or press [INC]/[DEC] to make the setting.
3. If you want to save your settings, press [F8 (System Write)]. Press [Exit] to return to the previous screen.

TIP

Realtime controller settings are saved independently for each performance as part of the performance settings. This lets you create performances that make effective use of controller settings.

Switch Assign

Specify the function that will be controlled by the assignable switch.

Value

TRANPOSE DOWN:	Lowers the key range in semitone steps (up to 5 semitones lower).
TRANPOSE UP:	Raises the key range in semitone steps (up to 6 semitones higher).
TAP TEMPO:	Tap tempo (a tempo specified by the interval at which you press the button).
MONO/POLY:	Pressed to toggle between polyphonic (POLY) and monophonic (MONO) play of a patch.
PORTAMENTO:	Portamento On/Off
HOLD:	Hold play On/Off
MFx1–3 SW:	Multi-effect 1–3 switch
CHORUS SW:	Chorus switch
REVERB SW:	Reverb switch
MASTERING SW:	Mastering switch
LOOP:	Loop play On/Off
RHY START/STOP:	Rhythm pattern playback On/Off

TIP

If Patch mode is selected, assignable switches are available when the keyboard part is selected.

Using a Pedal to Modify the Sound (Control Pedal)

You can modify the sound by pressing a pedal that is connected to the rear panel PEDAL HOLD jack or PEDAL CONTROL jack.

Pedal such as expression pedals (DP-8; available separately), pedal switches (DP series; available separately), or foot switches (BOSS FS-U; available separately) can be connected to the Fantom-X.

1. Access the Patch Play screen (p. 38).
2. While playing the keyboard to produce sound, operate a pedal.
The sound will change according to the function that is assigned to the control pedal.

Making Control Pedal Settings

1. Press [MENU].
2. Use ▲ or ▼ to select “System,” and then press [ENTER].
The System Setup screen appears.
3. Press [F1 (⏏)] or [F2 (⏏)] to select “Pedal/D Beam.”
A screen like the following appears.

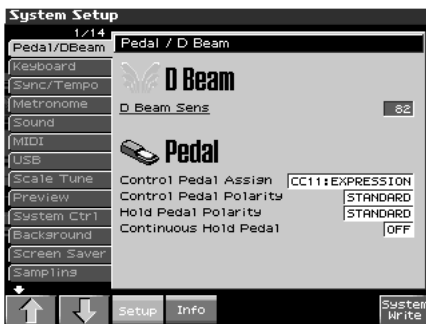

4. Turn the VALUE dial or press [INC]/[DEC] to make the setting.
5. If you want to save your settings, press [F8 (System Write)]. Press [Exit] to return to the Patch Play screen.

Control Pedal Assign

This specifies the function of each pedal connected to the PEDAL CONTROL jacks.

Value

CC01–31, 33–95: Controller numbers 1–31, 33–95



For details on control change messages, refer to “MIDI Implementation” (p. 298).

BEND UP:	Controls the pitch as specified by the “Pitch Bend Range Up” setting (p. 67).
BEND DOWN:	Controls the pitch as specified by the “Pitch Bend Range Down” setting (p. 67).
AFTERTOUCHE:	Aftertouch
OCT UP:	Each pedal press raises the key range in octave steps (up to 3 octaves higher).
OCT DOWN:	Each pedal press lowers the key range in octave steps (up to 3 octaves lower).
START/STOP:	The sequencer will start/stop.
PUNCH IN/OUT:	Manual punch-in/out recording will start/stop.
TAP TEMPO:	Tap tempo (a tempo specified by the interval at which you press the pedal).
PROG UP:	The next sound number will be selected.
PROG DOWN:	The previous sound number will be selected.
FAVORITE UP:	The favorite patch/performance of the next number or bank will be selected.
FAVORITE DOWN:	The favorite patch/performance of the previous number or bank will be selected.
ARP SW:	Switches the Arpeggio/Rhythm function on/off.
RHY START/STOP:	Switch Rhythm pattern playback on/off.
CHORD SW:	Switches the Chord function on/off.
LIVE SET UP:	Switches to the next step within a Live Setting list.
LIVE SET DOWN:	Switches to the previous step within a Live Setting list.
LOOP:	Loop play On/Off

Control Pedal Polarity

Selects the polarity of the pedal. On some pedals, the electrical signal output by the pedal when it is pressed or released is the opposite of other pedals. If your pedal has an effect opposite of what you expect, set this parameter to “REVERSE.” If you are using a Roland pedal (that has no polarity switch), set this parameter to “STANDARD.”

Value: STANDARD, REVERSE

Hold Pedal Polarity

Select the polarity of the Hold pedal. On some pedals, the electrical signal output by the pedal when it is pressed or released is the opposite of other pedals. If your pedal has an effect opposite of what you expect, set this parameter to “REVERSE.” If you are using a Roland pedal (that has no polarity switch), set this parameter to “STANDARD.”

Range: STANDARD, REVERSE

Continuous Hold Pedal

This setting determines whether the HOLD PEDAL jack will provide support for half-pedaling (ON), or not (OFF). When this is set to support use of half-pedaling techniques, you can then connect an optional expression pedal (DP-8, etc.), and employ pedal work to achieve even finer control in performances in which piano tones are used.

Value: OFF, ON



Playing Arpeggios

About Arpeggio

The Fantom-X's Arpeggio function lets you produce arpeggios automatically; simply hold down some keys, and a corresponding arpeggio will be played automatically.

Not only can you use the factory-set **Arpeggio Styles**, which determine the way the arpeggio is played, but you can also freely rewrite Styles and enjoy performing your own original arpeggios. An Arpeggio Style is not part of any Performance, but rather independent data; you can store up to 128 Arpeggio Styles. Therefore you can use a single Arpeggio Style in different Patches and Performances. Arpeggio settings can be saved independently for each performance. However, they cannot be saved as part of a patch. What's more, you can perform in ensemble using these arpeggios and rhythm patterns (p. 135).

* You cannot play the arpeggio from the pads.

Playing Arpeggios

Turning Arpeggio On and Off

1. Press [ARPEGGIO] to turn it on.

The button will light.



2. Play a chord on the keyboard.

The Fantom-X will play an arpeggio, according to the notes forming the chord you have just voiced.

3. To finish playing arpeggios, press [ARPEGGIO] again to turn it off.

TIP

In arpeggio settings, the **Style (Arpeggio Style)** (p. 129) is particularly important. The playback pattern of the arpeggio is determined mainly by this selection.

cf.

For details regarding each parameter, refer to "Arpeggio Settings" (p. 129).

Using in Combination with the Chord Memory Function

When performing with the Arpeggio, you can also use it along with the Chord Memory function (p. 133). After first storing complex Chord Forms in memory, you can then call them up when Arpeggio function is on, and you can easily play complex arpeggio sounds just by pressing a single key.

Determining the Tempo for Arpeggio Performances

This sets the arpeggio tempo. You can save the arpeggio tempo settings individually in each Patch, Rhythm Set, or Performance.

1. Press [TEMPO].

The current tempo value appears in the display.



2. Press VALUE dial or [INC], [DEC] to set the tempo value (5–300), or set the value by tapping [F6 (Tap)] a number of times with the same rhythm (Tap Tempo).

* If you press [F7 (Click)] to light it in red, the click will sound.

3. When you have made the setting, press [F8 (Close)].

Using a controller to adjust the playback tempo

Since tempo control is assigned to one of the Fantom-X's realtime control knobs, it's easy to adjust the tempo while playing arpeggios.

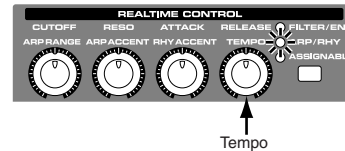

1. Press the REALTIME CONTROL button so the ARP/RHY indicator lights.
2. Play an arpeggio, and turn the realtime control knob.

Holding an Arpeggio

By using the following procedure, you can produce arpeggios even without continuing to press the keyboard.

1. Press [ARP HOLD].

The indicator will begin blinking.

2. Play a chord on the keyboard.

3. If you play a different chord or notes while the arpeggio is being held, the arpeggio will change accordingly.

4. To cancel Arpeggio Hold, press [ARP HOLD] once again.

When Using a Hold Pedal

If you play an arpeggio while pressing the hold pedal, the arpeggio will continue to be played even if you release the chord.

1. Connect an optional pedal switch (DP series etc.) to the HOLD PEDAL jack.
2. Press [ARPEGGIO] to turn on the arpeggio.
3. Play a chord while pressing the hold pedal.
4. If you play a different chord or notes while the arpeggio is being held, the arpeggio will change accordingly.

Playing Arpeggios Along with the Sequencer

When using arpeggios while the sequencer is playing, or when you want to record arpeggios into the sequencer in real time, you can synchronize the arpeggio with the start/stop timing of the sequencer.

For details, refer to “Arpeggio/Rhythm Sync Switch” (p. 227).

Arpeggio Settings

1. Hold down [SHIFT] and press [ARPEGGIO].

A screen like the one below appears.

If Performance mode is selected, (Performance) will appear at the right of “Arpeggio.”

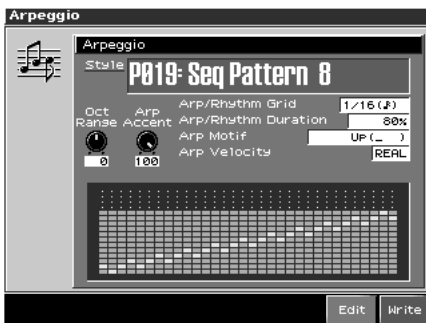

2. Press [CURSOR] to move the cursor to each parameter, and either turn the VALUE dial or press [INC] or [DEC] to make the setting.
3. When you have made the setting, press [EXIT].

Selecting Styles for Arpeggio Performances (Arpeggio Style)

This selects the arpeggio’s basic performance Style. The arpeggio styles are kept in preset memory and user memory.

Value: U001–128 (User), P001–128 (Preset)

About Arpeggio Styles

An Arpeggio Style is a series of data for basic arpeggio patterns and chord styles recorded in the form of a grid consisting of a maximum of 32 steps x 16 pitches.

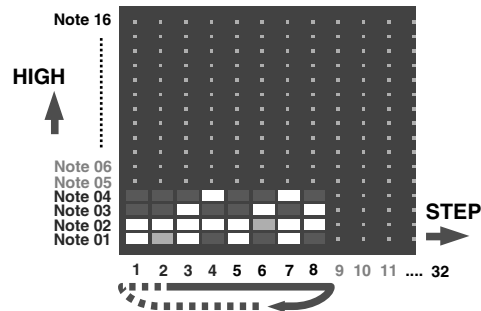

Each grid contains one of the following kinds of data.

- ON: Note On (with Velocity data)
- TIE: Tie (hold of the previous note)
- REST: Rest (no sound played)

The keys that are pressed along with the sequence in which they are pressed is referenced to the “lowest-pitched key during input.” Thus, you can use a single Arpeggio Style in different Patches and Performances at the same time.

An Arpeggio Style is not part of any patch or Performance, but rather independent data; you can store up to 64 Arpeggio Styles.

Changing the Beat and Shuffle (Arp/Rhythm Grid)

This sets the particular note division and resolution in a “single grid” used in creating the arpeggio in an Arpeggio Style, and how much of a “shuffle” syncopation is to be applied (none/weak/strong) to it (grid type).

* Grid settings are shared with the rhythm pattern.

Value:

- 1/4:** Quarter note (one grid section = one beat)
- 1/8:** Eighth note (two grid sections = one beat)
- 1/8L:** Eighth note shuffle Light (two grid sections = one beat, with a light shuffle)
- 1/8H:** Eighth note shuffle Heavy (two grid sections = one beat, with a heavy shuffle)
- 1/12:** Eighth note triplet (three grid sections = one beat)
- 1/16:** Sixteenth note (four grid sections = one beat)
- 1/16L:** Sixteenth note shuffle Light (four grid sections = one beat, with a light shuffle)
- 1/16H:** Sixteenth note shuffle Heavy (four grid sections = one beat, with a heavy shuffle)
- 1/24:** Sixteenth note triplet (six grid sections = one beat)

Playing Arpeggios

Applying Staccato and Tenuto (Arp/Rhythm Duration)

This setting (duration) determines whether the sounds are played staccato (short and clipped), or tenuto (fully drawn out).

* Grid settings are shared with the rhythm pattern.

- Value:** 30, 40, 50, 60, 70, 80, 90, 100, 120, Full
- 30–120:** For example, when set to “30,” the length of the note in a grid (or when a series of grids is connected with ties, the final grid) is 30% of the full length of the note set in the grid type.
- FUL (Full):** Even if the linked grid is not connected with a tie, the same note continues to sound until the point at which the next new sound is specified.

Selecting Ascending/Descending Variations (Different Ways of Playing the Sounds) (Arp Motif)

This selects the method used to play sounds (motif) when you have a greater number of notes than programmed for the Arpeggio Style.

MEMO

When the number of keys played is less than the number of notes in the Style, the highest-pitched of the pressed keys is played by default.

- Value:**
- UP (L):** Only the lowest of the keys pressed is sounded each time, and the notes play in order from the lowest of the pressed keys.
- UP (L&H):** Notes from both the lowest and highest pressed keys are sounded each time, and the notes play in order from the lowest of the pressed keys.
- UP (_):** The notes play in order from the lowest of the pressed keys. No one note is played every time.
- DOWN (L):** Only the lowest of the keys pressed is sounded each time, and the notes play in order from the highest of the pressed keys.
- DOWN (L&H):** Notes from both the lowest and highest pressed keys are sounded each time, and the notes play in order from the highest of the pressed keys.
- DOWN (_):** The notes play in order from the highest of the pressed keys. No note is played every time.
- UP&DOWN (L):** Notes will be sounded from the lowest to the highest key you press and then back down to the lowest key, with only the lowest key sounded each time.
- UP&DOWN (L&H):** Notes from both the lowest and highest pressed keys are sounded each time, and the notes play in order from the lowest of the pressed keys and then back again in the reverse order.
- UP&DOWN (_):** The notes play in order from the lowest of the pressed keys, and then back again in the reverse order. No note is played every time.

- RANDOM (L):** Notes will be sounded randomly for the keys you press, with only the lowest key sounded each time.
- RANDOM (_):** Only the lowest of the keys pressed is sounded each time, the notes you press will be sounded randomly. No note will sound each time.
- PHRASE:** Pressing just one key will play a phrase based on the pitch of that key. If you press more than one key, the key you press last will be used.

<Example>

Action of a Style starting from the lowest note, “1-2-3-2” when the keys “C-D-E-F-G” are played

When “UP (L)” is selected as the motif:

C-D-E-D -> C-E-F-E -> C-F-G-F (-> repeated)

When “UP (_)” is selected as the motif:

C-D-E-D -> D-E-F-E -> E-F-G-F (-> repeated)

When “UP&DOWN (L&H)” is selected as the motif:

C-D-G-D -> C-E-G-E -> C-F-G-F -> C-E-G-E (-> repeated)

Adjusting the Velocity of the Arpeggio (Arp Velocity)

Specifies the loudness of the notes that you play.

If you want the velocity value of each note to depend on how strongly you play the keyboard, set this parameter to REAL. If you want each note to have a fixed velocity regardless of how strongly you play the keyboard, set this parameter to the desired value (1–127).

Value: REAL, 1–127

Selecting the Part that Will Play Arpeggios in Performance Mode (Arp Part)

Here’s how to specify the part that will use the arpeggio in Performance mode. You can specify only one part for playing arpeggios.

If a rhythm set is assigned to a part in Performance mode, you can play a rhythm pattern along with the arpeggios.

The part you select here functions for both the arpeggio and the chord memory functions.

Value: Part1–16

Changing the Accent Strength (Arp Accent)

When you play arpeggios, the velocity of each arpeggiated note is determined by the velocity of the notes programmed within the arpeggio style. You can adjust the amount (“spread”) of this dynamic variation. With a setting of 100%, the arpeggiated notes will have the velocities that are programmed by the arpeggio style. With a setting of 0%, all arpeggiated notes will be sounded at a fixed velocity.

Value: 0-100%



You can also use a REALTIME CONTROL knob to control this.

Hanging the Range of the Arpeggio (Oct Range)

This adds an effect that shifts arpeggios one cycle at a time in octave units (octave range). You can set the shift range upwards or downwards (up to three octaves up or down).

Value: -3-0+3



You can also use a REALTIME CONTROL knob to control this.

Using the Realtime Control Knobs to Edit the Arpeggio Settings

You can use the realtime control knobs to change the arpeggio settings by editing the parameters in real time.

1. Play arpeggios.
2. Press the REALTIME CONTROL button to select "ARP/RHY."

The "ARP/RHY" indicator will light.

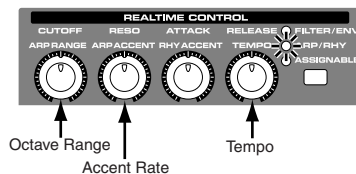

3. Turn the REALTIME CONTROL knobs.
- While arpeggios are playing, you can use the knobs to control the following parameters.
- "Hanging the Range of the Arpeggio (Oct Range)" (p. 131)
 - "Changing the Accent Strength (Arp Accent)" (p. 130)

Creating an Arpeggio Style (Arpeggio Style Edit)

In addition to using the built-in arpeggio styles, you are free to create your own. After creating an original arpeggio style, you can store it in the internal user memory.

Broadly speaking, there are two ways to create an arpeggio style.

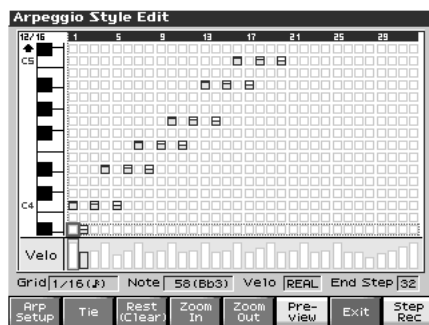

Step-recording

In this method, you use the keyboard and pads to step-record your arpeggio. Each time you input a note, you will advance to the next step. This method is convenient when you want to create an arpeggio from scratch using a Style that contains no data.

MEMO

If you want to create "from scratch," you'll need to initialize the Style. In the Arpeggio Style Edit screen, hold down [SHIFT] and press [F1 (Init)]. A message will ask whether you want to initialize; press [F8 (Exec)] to execute initialization.

1. Hold down [SHIFT] and press [ARPEGGIO].
2. Press [F7 (Edit)].
The Arpeggio Style Edit screen will appear.
3. Press [F1 (Arp Setup)].
The Arpeggio Setup screen will appear.
4. Move the cursor to "End Step," and specify the number of steps for the arpeggio style you want to create.
5. Move the cursor to "Input Velocity," and specify the velocity setting for the data you will input.
 - With the "Real" setting, the velocity will depend on the strength with which you actually strike the keyboard or pads.
 - With a numerical setting of "1-127," the data will always be input with the specified velocity, regardless of how strongly you strike the keyboard or pads.

Make the desired setting, and then press [F8 (Close)] to close the Arpeggio Setup screen.
6. Press [F8 (Step Rec)] so it lights red.
Now you're ready to step-record. Play the keyboard or pads to input notes.

* To input a tie, press [F2 (TIE)].

* To input a rest, press [F3 (Rest (Clear))].

* You can use [F4 (Zoom In)]/[F5 (Zoom Out)] to zoom the display in or out.

* You can press [F6 (Preview)] to audition the style you've input.

Using the Dial or [INC][DEC] to Input Values

In this method, you'll use the cursor to specify the step or pitch that you want to input, and use the dial or [INC][DEC] to input values. This method is convenient when you want to edit or modify previously input data.

1. **Hold down [SHIFT] and press [ARPEGGIO].**
2. **Press [F7 (Edit)].**
The Arpeggio Style Edit screen will appear.
3. **Press [F1 (Arp Setup)].**
The Arpeggio Setup screen will appear.
4. **Move the cursor to "End Step," and specify the number of steps for the arpeggio style you want to create.**
Make the desired setting, and then press [F8 (Close)] to close the Arpeggio Setup screen.
5. **Use [CURSOR] to specify the step or pitch you want to input.**
 - * When using this method of input, you can use the keyboard to specify the pitch of the note. (Unlike when step-recording, pressing the keyboard will not actually input the note.)
6. **Input the velocity value, using either the VALUE dial or [INC][DEC].**
You can input a tie by turning VALUE all the way to the right (or using [INC] to raise the value all the way).
 - * You can also input a tie by pressing [F2 (TIE)].
 - * To input a rest, press [F3 (Rest (Clear))].
 - * You can use [F4 (Zoom In)]/[F5 (Zoom Out)] to zoom the display in or out.
 - * You can press [F6 (Preview)] to audition the style you've input.
 - * When using this method of input, you can use the pads to specify the velocity and finalize your input; after you've specified the step and pitch to be input, strike a pad to input it.
(Higher-numbered pads produce higher velocity values; for example, striking pad 1 specifies a velocity value of 8, while striking pad 16 specifies a velocity value of 127.)

NOTE

A maximum of sixteen note numbers (pitches) can be used in a single style.

Saving the Styles You Have Created (Write)

The Styles you create are temporary; they are deleted as soon as you turn off the power or select some other Style. You can store 128 arpeggio styles in the User memory.

Arpeggio style settings are saved as independent data, not as part of the data for each patch. The settings in Patch mode, it is not possible to save arpeggio parameters (e.g., arpeggio style, grid type, motif, duration, octave range).
It can be saved to individual in Performance mode. If you want to save your settings, press [WRITE] and save the performance.

1. **Confirm that the current Style is the one you want to save.**
2. **Press [F3 (Arp)].**
3. **Press [F8 (Write)].**
The Arpeggio name entry screen will appear (p. 36).
4. **When you have finished entering the name, press [F8 (Write)].**
A screen in which you can select the destination for the write will appear.
5. **Turn the VALUE dial or use [INC] [DEC] to select the write destination.**
6. **Press [F8 (Write)].**
A message will ask you for confirmation.
7. **To write the data, press [F8 (Exec)].**
Never switch off the Fantom-X while data is being saved.
 - * To cancel, press [F7 (Cancel)].

Using the Chord Memory Function (Chord Memory)

About the Chord Memory Function

Chord Memory is a function that allows you to play chords based on pre-programmed **Chord Forms**, just by pressing a single key on the keyboard. The Fantom-X can store 64 preset chord forms and 64 user chord forms. If you wish, you can overwrite any of the 64 user (factory set) chord forms.

The chord memory function operates on the arpeggio part in Performance mode. If a rhythm set is selected for that part, you can also use this to play rhythms.

* You cannot use the chord memory function with the pads.

NOTE

When you use the Chord Memory function with a tone for which the Mono/Poly Parameters (p. 77) is Mono, only one sound in the chord is played. When using the Chord Memory function to turn Poly the Mono/Poly Parameters.

Using in Combination with the Arpeggio Function

When performing with the Chord Form function, you can also use it along with the Arpeggio function (p. 128). After first storing complex Chord Forms in memory, you can then call them up when Arpeggio is on, and you can easily create complex arpeggio sounds just by pressing a single key.

Performing with the Chord Memory Function

Turning Chord Memory Function On and Off

1. Press **[CHORD MEMORY]** to turn it on.
The button will light.



2. Play the keyboard.
A chord will sound according to the currently selected chord form.

MEMO

When you press the C4 key (Middle C), the chord is played using the exact chord structure recorded in the Chord Form. This is referenced to the C4 key; parallel chords are played by pressing other keys.

3. To finish playing arpeggios, press **[CHORD MEMORY]** again to turn it off.

Selecting Chord Forms

Changing the chord form will change the notes in the chord.

1. Hold down **[SHIFT]** and press **[CHORD MEMORY]**.
The following screen appears.
If Performance mode is selected, (Performance) will appear at the right of "Chord Form."

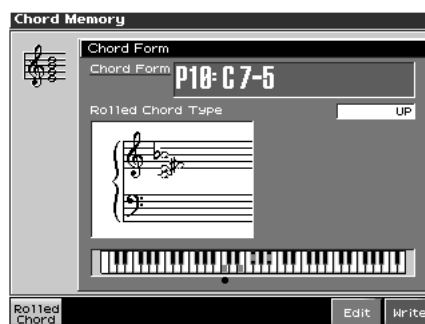

2. Either turn the **VALUE** dial or use **[INC]/[DEC]** to select a **Chord Form** number.
The notes of the chord will be displayed.
3. When you have finished selecting a **Chord Form**, press **[Exit]**.

Using the Chord Memory Function (Chord Memory)

Sounding a chord in the order of its notes (Rolled Chord)

This causes the notes within a chord to be sounded consecutively, rather than simultaneously. Since the playback speed will change according to the force with which you play the keyboard, you can vary your playing dynamics to create a realistic simulation of playing a guitar.

1. Hold down [SHIFT] and press [CHORD MEMORY].

The chord memory screen appears.

2. Press [F1 (Rolled Chord)] so it lights red.

With this setting, the notes of the chord will be sounded consecutively when you play the keyboard.

Changing the order in which notes are sounded

You can change the order in which the notes of a chord are sounded.

1. Hold down [SHIFT] and press [CHORD MEMORY].

The chord memory screen appears.

2. Use ▲ or ▼ to select "Rolled Chord Type."

3. Either turn the VALUE dial or use [INC]/[DEC] to change a value.

Value

UP: Notes will be sounded in order from bottom to top.

DOWN: Notes will be sounded in order from top to bottom.

ALTERNATE: The order in which the notes are sounded will change each time you play the keyboard.

Creating Your Own Chord Forms

Not only can you use the prepared internal Chord Forms, which determine the constituent notes of chords played using the Chord Memory function, but you can also freely create and rewrite them as well.

1. Hold down [SHIFT] and press [CHORD MEMORY].

2. Turn the VALUE dial to select a chord form.

3. Press [F7 (Edit)].

The Chord Form Edit screen appears.

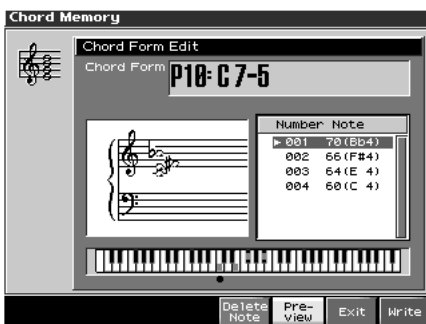

4. Use the keyboard to input the chord that you want to play.

When you press a key, the note will be added in the screen.

If you input a note by mistake, press [F5 (Del Note)].

You can also erase a note you input by pressing the same key.

You can press [F6 (Preview)] to hear the chord that you are inputting.

5. If you want to save the chord form you created, proceed to step 3 of "Saving the Chord Forms You Have Created." If you don't want to save it, press [F7 (Exit)].

Saving the Chord Forms You Have Created

The Chord Form you create are temporary; they are deleted as soon as you turn off the power or select some other Style. If you want to keep a Chord Form you have made, save it to the Fantom-X's user memory.

A chord form is not part of any patch or performance, but rather independent data. Therefore you can use a single chord form in different Patches and Performances. In Performance mode you can save these settings individually for each performance. These settings cannot be saved in a patch.

If you want to save your settings, press [WRITE] and save the performance.

1. Hold down [SHIFT] and press [CHORD MEMORY].

Confirm that the chord form the one you want to save.

2. Press [F8 (Write)].

The Chord Form name entry screen will appear (p. 36).

3. When you have finished entering the name, press [F8 (Write)].

A screen will appear, allowing you to select the write destination.

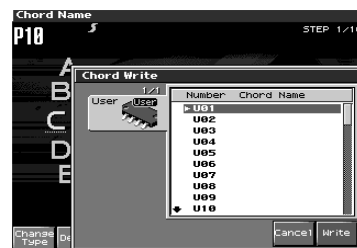

4. Use ▲ or ▼ to select the write destination.

5. Press [F8 (Write)].

A message will ask you confirm.

6. To save the chord form, press [F8 (Exec)].

Never switch off the Fantom-X while data is being saved.

* To cancel, press [F7 (Cancel)].

Playing Rhythms

About Rhythm Patterns

The Fantom-X contains 256 preset rhythm patterns. You can play a variety of rhythm patterns simply by pressing the pads. In addition to using these built-in rhythm patterns, you can also create your own.

The 256 rhythm patterns are maintained as independent data; they are not part of a performance's data. This means that any one rhythm pattern can be shared by various rhythm sets or performances. In Performance mode, a number by which a rhythm pattern is recalled can be stored as one of the performance parameters. This number cannot be stored in Patch mode.

Rhythm Patterns and Rhythm Groups

On the Fantom-X, a set of rhythm pattern numbers, percussion instrument sounds and a rhythm set assigned to the sixteen pads is stored as a Rhythm Group.

Using Rhythm Groups

A "group" consists of settings for each of the sixteen pads, specifying the pattern that each pad will play. The rhythm set used by that group is also stored as part of the settings.

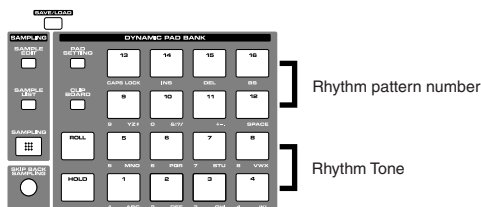

* You are free to change how rhythm pattern numbers and rhythm sounds are assigned.

Rhythm group data is not part of a rhythm set or performance; the 32 rhythm groups are stored as independent data. This means that any one rhythm group can be shared by various patches or performances. In addition to using the built-in rhythm groups, you can also create your own.

Rhythm Group settings can be saved independently for each performance. However, they cannot be saved as part of a patch.

Playing Rhythm

Turning Rhythm On and Off

1. Press [RHYTHM] to turn it on.

The button will light.



2. Play a pad (9-16).

According to the pad you pressed, the assigned rhythm pattern will begin playing.

The volume of the rhythm pattern will also change according to how strongly you strike the pad.

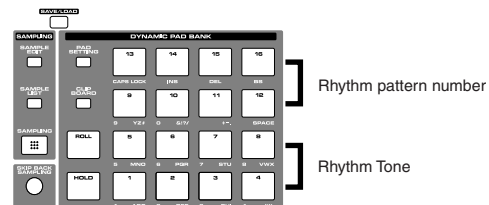

A pattern will begin playing when you press any pad from 9-16 that isn't illuminated. A rhythm tone will sound when you press a pad that is blink. The pattern or rhythm tone that is sounded by each pad can be specified in Rhythm Group Edit (p. 139).

- * You can stop playback by pressing a blinking pad.
- * To stop rhythm pattern playback, press [RHYTHM] once again so the indicator goes out.

Determining the Tempo for Rhythm Pattern Performances

This sets the Rhythm Pattern tempo. Specify the tempo of the rhythm pattern.

1. Play a rhythm pattern (p. 135).

2. Press [TEMPO].

The current tempo value appears in the display.



3. Press VALUE dial or [INC], [DEC] to set the tempo value (5-300), or set the value by tapping [F6 (Tap)] a number of times with the same rhythm (Tap Tempo).

* When you press [F7 (Click)] to light it in red, the click will sound.

Playing Rhythms

- When you have made the setting, press [F8 (Close)].

Using a controller to adjust the playback tempo

Since tempo control is assigned to one of the Fantom-X's realtime control knobs, it's easy to adjust the tempo at which the rhythm pattern will play back.

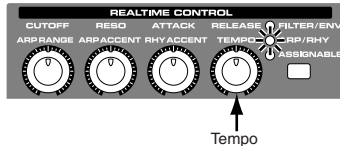

- Press the REALTIME CONTROL button so the ARP/RHY indicator lights.
- Play an Rhythm Pattern, and turn the realtime control knob.

Select the Rhythm Group

- Hold down [SHIFT] and press [RHYTHM].
- Press [F1 (Rhythm Group)].

A screen like the one below appears.

If Performance mode is selected, (Performance) will appear at the right of "Rhythm Group."

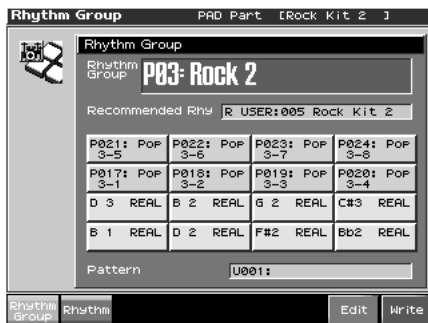

* When you select the Rhythm group, the most suitable rhythm set is assigned to the Pad part. (In the screen, this is indicated by "Recommended Rhy (Recommended Rhythm set).")

- Turn the VALUE dial or press [INC] or [DEC] to make the setting.
This selects the Rhythm group's basic performance Style.
Value: P01–32 (Preset), U01–32 (User)
- When you have made the setting, press [EXIT].

Rhythm Pattern Settings

- Hold down [SHIFT] and press [RHYTHM].
- Press [F2 (Rhythm)].

A screen like the one below appears.

If Performance mode is selected, (PERFORMANCE) will appear at the right of "Rhythm Pattern."



- Press ▲ or ▼ to move the cursor to each parameter, and either turn the VALUE dial or press [INC] or [DEC] to make the setting.

MEMO

You can audition the rhythm pattern by pressing [F6 (Preview)] so it lights in red. When you've finished auditioning the pattern, press [F6 (Preview)] once again to stop.

- When you have made the setting, press [EXIT].

Selecting Rhythm Patterns

Select the basic playing style of the rhythm.

This selects the rhythm's basic performance Style.

Value: P001–256 (Preset), U001–256 (User)

Changing the Beat and Shuffle (Grid)

This sets the particular note division and resolution in a “single grid” used in creating the pattern in an Rhythm Pattern, and how much of a “shuffle” syncopation is to be applied (none/weak/strong) to it (grid type).

* Grid settings are shared with the arpeggio.

Value:

- 1/4:** Quarter note (one grid section = one beat)
- 1/8:** Eighth note (two grid sections = one beat)
- 1/8L:** Eighth note shuffle Light (two grid sections = one beat, with a light shuffle)
- 1/8H:** Eighth note shuffle Heavy (two grid sections = one beat, with a heavy shuffle)
- 1/12:** Eighth note triplet (three grid sections = one beat)
- 1/16:** Sixteenth note (four grid sections = one beat)
- 1/16L:** Sixteenth note shuffle Light (four grid sections = one beat, with a light shuffle)
- 1/16H:** Sixteenth note shuffle Heavy (four grid sections = one beat, with a heavy shuffle)
- 1/24:** Sixteenth note triplet (six grid sections = one beat)

Applying Staccato and Tenuity (Duration)

This setting (duration) determines whether the sounds are played staccato (short and clipped), or tenuity (fully drawn out).

* Grid settings are shared with the arpeggio.

- Value:** 30, 40, 50, 60, 70, 80, 90, 100, 120, Full
- 30–120:** For example, when set to “30,” the length of the note in a grid (or when a series of grids is connected with ties, the final grid) is 30% of the full length of the note set in the grid type.
- FUL (Full):** Even if the linked grid is not connected with a tie, the same note continues to sound until the point at which the next new sound is specified.

NOTE

This has no effect if the Tone Env Mode parameter (p. 87) is set to “No Sus.”

Changing the velocity of Rhythm Pattern (Rhythm Pattern Velocity)

This specifies the strength with which the Pads you press will be sounded. If you want the velocity to change according to the force with which you press the Pads, set this to “REAL.” If you want the velocity to be a fixed value regardless of the force with which you press the Pads, specify the desired value (1–127).

Value: REAL, 1–127

Changing the Accent Strength (Rhythm Accent)

When you play rhythm patterns, the velocity of each note is determined by the velocity of the notes programmed within the arpeggio style. You can adjust the amount (“spread”) of this dynamic variation. With a setting of 100%, the notes will have the velocities that are programmed by the rhythm pattern. With a setting of 0%, all notes will be sounded at a fixed velocity.

Value: 0–100%



You can also use a REALTIME CONTROL knob to control this.

Using the Realtime Control Knobs to Control the Rhythm

Here’s how you can use the realtime control knobs to control the rhythm in real time by adjusting the rhythm parameters.

1. Play rhythm.
2. Press the REALTIME CONTROL button to select “ARP/RHY.”

The “ARP/RHY” indicator will light.

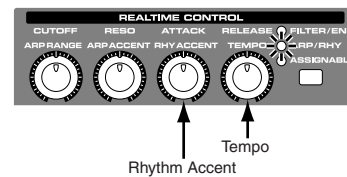

3. Turn the REALTIME CONTROL knobs.
 - While Rhythm Pattern are playing, you can use the knobs to control the following parameters.
 - Rhythm Accent Rate -> p. 137
 - TEMPO -> p. 135

Creating an Rhythm Pattern (Rhythm Pattern Edit)

In addition to using the built-in Rhythm Patterns, you are free to create your own. After creating an original Rhythm Pattern, you can store it in the internal user memory.

Broadly speaking, there are two ways to create an Rhythm Pattern.

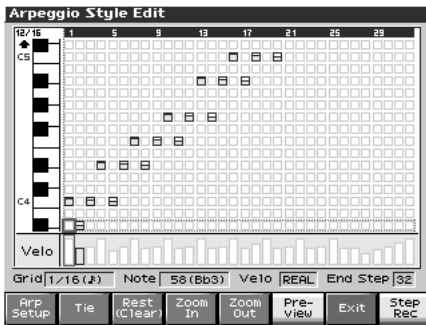

Step-recording

In this method, you use the keyboard and pads to step-record your Rhythm pattern. Each time you input a note, you will advance to the next step. This method is convenient when you want to create a Rhythm pattern from scratch using a Style that contains no data.

MEMO

If you want to create “from scratch,” you’ll need to initialize the Style. In the Rhythm Pattern Edit screen, hold down [SHIFT] and press [F1 (Init)]. A message will ask whether you want to initialize; press [F8 (Exec)] to execute initialization.

1. Hold down [SHIFT] and press [RHYTHM].
2. Press [F2 (Rhythm)].
3. Press [F7 (Edit)].
The Rhythm Pattern Edit screen will appear.
4. Press [F1 (Rhythm Setup)].
The Rhythm Setup screen will appear.
5. Move the cursor to “End Step,” and specify the number of steps for the Rhythm Pattern you want to create.
6. Move the cursor to “Input Velocity,” and specify the velocity setting for the data you will input.
 - With the “Real” setting, the velocity will depend on the strength with which you actually strike the keyboard or pads.
 - With a numerical setting of “1–127,” the data will always be input with the specified velocity, regardless of how strongly you strike the keyboard or pads.

Make the desired setting, and then press [F8 (Close)] to close the Rhythm Setup screen.
7. Press [F8 (Step Rec)] so it lights red.
Now you’re ready to step-record. Play the keyboard or pads to input notes.

- * To input a tie, press [F2 (TIE)].
- * To input a rest, press [F3 (Rest (Clear))].
- * You can use [F4 (Zoom In)]/[F5 (Zoom Out)] to zoom the display in or out.
- * You can press [F6 (Preview)] to audition the style you’ve input.

Using the Dial or [INC][DEC] to Input Values

In this method, you’ll use the cursor to specify the step or pitch that you want to input, and use the dial or [INC][DEC] to input values. This method is convenient when you want to edit or modify previously input data.

1. Hold down [SHIFT] and press [RHYTHM].
2. Press [F7 (Edit)].
The Rhythm Pattern Edit screen will appear.
3. Press [F1 (Rhythm Setup)].
The Rhythm Setup screen will appear.
4. Move the cursor to “End Step,” and specify the number of steps for the Rhythm Pattern you want to create.
Make the desired setting, and then press [F8 (Close)] to close the Rhythm Setup screen.
5. Use [CURSOR] to specify the step or pitch you want to input.
 - * When using this method of input, you can use the keyboard to specify the pitch of the note. (Unlike when step-recording, pressing the keyboard will not actually input the note.)
6. Input the velocity value, using either the VALUE dial or [INC][DEC].
You can input a tie by turning VALUE all the way to the right (or using [INC] to raise the value all the way).
 - * You can also input a tie by pressing [F2 (TIE)].
 - * To input a rest, press [F3 (Rest (Clear))].
 - * You can use [F4 (Zoom In)]/[F5 (Zoom Out)] to zoom the display in or out.
 - * You can press [F6 (Preview)] to audition the style you’ve input.
 - * When using this method of input, you can use the pads to specify the velocity and finalize your input; after you’ve specified the step and pitch to be input, strike a pad to input it. (Higher-numbered pads produce higher velocity values; for example, striking pad 1 specifies a velocity value of 8, while striking pad 16 specifies a velocity value of 127.)

NOTE

A maximum of sixteen note numbers (pitches) can be used in a single style.

Saving the Patterns You Have Created (Write)

The rhythm patterns you create are temporary; they are deleted as soon as you turn off the power or select some other rhythm patterns. You can store 256 rhythm patterns in the User memory.

Rhythm pattern settings are saved as independent data, not as part of the data for each patch. The settings in Patch mode, it is not possible to save rhythm pattern parameters (e.g., pattern, grid type).

It can be saved to individual in Performance mode. If you want to save your settings, press [WRITE] and save the performance.

1. Confirm that the current Pattern is the one you want to save.
2. In the Rhythm Pattern screen, press [F2 (Rhythm)].
3. Press [F8 (Write)].
The name entry screen will appear (p. 36).
4. When you have finished entering the name, press [F8 (Write)].
A screen in which you can select the destination for the write will appear.

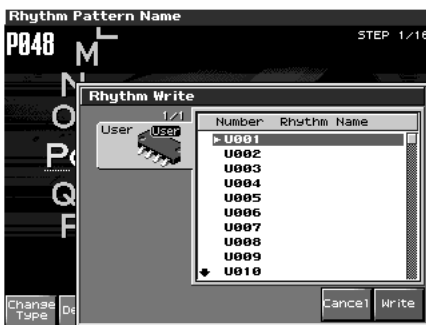

5. Turn the VALUE dial or use ▲, ▼ to select the write destination.
6. Press [F8 (Write)].
A message will ask you for confirmation.
7. To write the data, press [F8 (Exec)].
Never switch off the Phantom-X while data is being saved.
* To cancel, press [F7 (Cancel)].

Creating Your Own Styles (Rhythm Group Edit)

Not only can you use the prepared internal **Rhythm Groups** that determine how rhythm are played, but you can also create them as well. This way, you can enjoy performing your own original rhythm group.

1. Hold down [SHIFT] and press [RHYTHM].
2. Press [F1 (Rhythm Group)].
Turn the VALUE dial, or press [INC][DEC] to select a rhythm group you want to edit.
3. Press [F7 (Edit)].
The Rhythm Group edit screen will appear.



4. Use [CURSOR] to select a parameter, and turn the VALUE dial or use [INC][DEC] to set the value.
 - **PAD**
Select the pad for which you want to make settings.
* You can also choose the pad that you want to set by pressing that pad.
 - **Recommended Rhy (Recommended Rhythm Set)**
Specifies which rhythm set will be used.
 - **Pad Mode**
Specifies whether a rhythm tone or a rhythm pattern number will be assigned to the pad.
Range: Pattern, Note, Off
 - **Rhythm Pattern (Rhythm Pattern Number)**
If Pad Mode is set to Pattern, specifies the pattern number that will sound when you press the pad.
Range: U001–256, P001–256
 - **Rhythm Pattern Velocity**
Specifies the velocity of the rhythm pattern when the pad mode is set to "Pattern."
Range: REAL, 1–127
 - **Pad Note**
If Pad Mode is set to Note, specifies the note number that will sound when you press the pad.
Range: C-1 –G9
 - **Pad Velocity**
Specifies the strength of the sound heard when you strike the pad. If this is set to REAL, you can add dynamics by varying the strength of your strike.
Range: REAL, 1–127
5. If you want to save the rhythm group you created, proceed to step 4 of "Saving the Rhythm Group You Have Created (Write)" (p. 140). If you don't want to save it, press [F7 (Exit)].

Saving the Rhythm Group You Have Created (Write)

The Rhythm Group you create are temporary; they are deleted as soon as you turn off the power or select some other Style. You can store 32 Rhythm Groups in the User memory.

Rhythm group settings are saved as independent data, not as part of the data for each patch. The settings in Patch mode, it is not possible to save rhythm group settings.

It can be saved to individual in Performance mode. If you want to save your settings, press [WRITE] and save the performance.

1. **Confirm that the current Rhythm Group is the one you want to save.**
2. **Hold down [SHIFT] and press [RHYTHM].**
3. **Press [F1 (Rhythm Group)].**
4. **Press [F8 (WRITE)].**
The name entry screen will appear (p. 36).
5. **When you have finished entering the name, press [WRITE].**
A screen in which you can select the destination for the write will appear.



6. **Turn the VALUE dial or use ▲, ▼ to select the write destination.**
7. **Press [F8 (Write)].**
A message will ask you for confirmation.
8. **To write the data, press [F8 (Exec)].**
Never switch off the Fantom-X while data is being saved.
** To cancel, press [F7 (CANCEL)].*

Sampling

The Fantom-X lets you sample audio sources, such as an audio device, mic, or CD.

This section explains the sampling procedure and what the parameters do.

Switching external input on/off

1. Press [MIX IN] to turn it on.
The button will light.

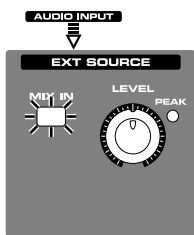

2. To turn it off, press [MIX IN] again.

Making Input Source Settings (Input Setting)

1. Connect your CD player, mic, or other audio source to the AUDIO INPUT jacks or to the DIGITAL IN connector located on the rear panel of the Fantom-X.

Cautions when using a microphone

Howling could be produced depending on the location of microphones relative to speakers. This can be remedied by:

1. Changing the orientation of the microphone(s).
2. Relocating microphone(s) at a greater distance from speakers.
3. Lowering volume levels.

2. Hold down [SHIFT] and press [MIX IN].

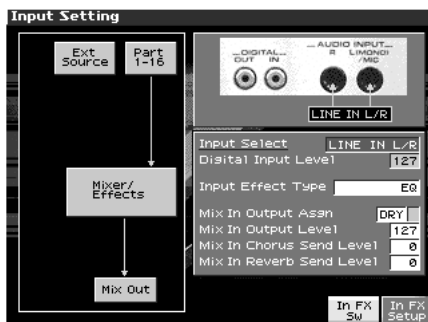

3. Press ▲ or ▼ to select the parameter that you want to set.
4. Turn the VALUE dial or press [INC]/[DEC] to set the value.

- **Input Select**

Specifies the input source of the sound to be sampled.

Value

- DIGITAL IN:** DIGITAL IN connector
- LINE IN L/R:** INPUT jacks L/R (stereo)
- LINE IN L:** INPUT jack L (mono)
- MICROPHONE:** INPUT jack L (mono, mic level)

- **Digital Input Level**

If you've set Input Select to DIGITAL IN, this adjusts the input level from the DIGITAL IN connector.

Value: 0–127

MEMO

You can also control the Digital Input Level using an assignable knob (p. 125).

- **Input Effect Type**

Selects the type of effect that will be applied to the external input source.

Value: EQ, ENHANCER, COMPRESSOR, LIMITER, NOISE SUP, C CANCELLER

When you press [F8 (In FX Setup)], the parameter setting screen for the currently selected input effect will be displayed "Making Input Source Settings (Input Setting)" (p. 141).

- **Mix In Output Asgn (Mix In Output Assign)**

Output destination of the external input sound that is mixed in

Value

DRY: Output to OUTPUT (A) jacks without passing through effects

MFX: Output through multi-effects

When you select "MFX," selects which of the three multi-effects (1–3) will be used.

- **Mix In Output Level**

Volume level of the external input sound.

Value: 0–127

- **Mix In Chorus Send Level**

Adjusts the depth of chorus that will be applied to the external input source. Set this to "0" if you do not want to apply chorus.

Value: 0–127

- **Mix In Reverb Send Level**

Depth of reverb applied to the external input sound. Set this to 0 if you don't want to apply reverb.

Value: 0–127

- **Input Effect SW**

Specifies whether the external input sound will be sent through the effects processor (Input Effect). You can switch this on by pressing [F7 (In FX Sw)] so it lights red. Press it once again to turn it off.

Value: ON, OFF

5. Play back the external input source.

Sampling

- If you use **AUDIO INPUT**, turn the **EXT SOURCE LEVEL** knob to adjust the volume.

* If you're using **DIGITAL IN**, this adjustment is not necessary.



* If the volume of the external source is too high, the **PEAK** indicator will light. If this occurs, turn down the **LEVEL** knob until the **PEAK** indicator no longer lights.

- Press **[EXIT]** to return to the previous screen.

Input Effect Setup Settings

- Hold down **[SHIFT]** and press **[MIX IN]**.

- Press **[F8 (In FX Setup)]**.

The Input Effect Setup screen appears.

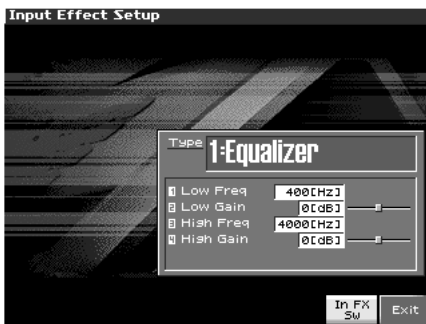

- Press **▲** or **▼** to move the cursor.
- Turn the **VALUE** dial, or press **[INC] / [DEC]** to set the value.
 - Type (Input Effect Type)**

Selects the input effect type.

Parameter	Explanation
1: Equalizer	Adjusts the tone of the low-frequency and high-frequency ranges.
2: Enhancer	Modifies the harmonic content of the high-frequency range to add sparkle to the sound.
3: Compressor	Restrains high levels and boosts low levels to make the overall volume more consistent.
4: Limiter	Compresses the sound when it exceeds a specified volume, to keep distortion from occurring.
5: Noise Suppressor	Suppresses noise during periods of silence.
6: Center Canceler	Removes the sounds that are localized at the center of the stereo input. This is a convenient way to eliminate a vocal.

In this settings screen, you can edit parameters for the type of input effect you selected.

MEMO

When you enter the Input Effect Setup screen, the indicator at the right of the Realtime Control knobs will go out, and the Realtime Control knobs can be used to edit the MFX parameters. If you once again press the button located at the right of the Realtime Control knobs so the indicator is lit, the knobs will control their original functions. When you exit the Input Effect Setup screen, the indicator will automatically return to its previous lit state.

- Press **[EXIT]** to return to the previous screen.

MEMO

For details on the parameters that can be edited, refer to the section "**Input Effect Parameters**" (p. 294)

Sampling Procedure

- Press **[SAMPLING]** to access the Sampling Menu screen.

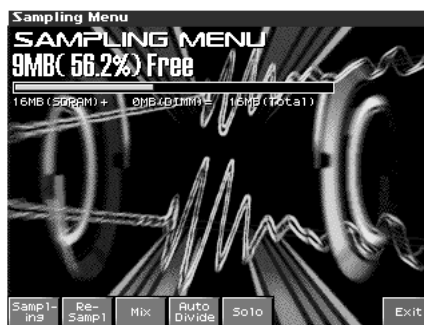
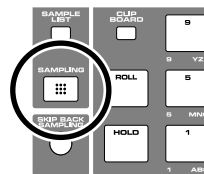

The upper part of the screen will show the amount of free memory. If the free memory reaches 0%, no further sampling is possible.

- Press **[F1 (Sampling)]**–**[F5 (SOLO)]** to select the sampling mode. The sampling-standby screen will appear.

To cancel, press **[F8 (Exit)]**.

* You cannot sample the sound that is output from the **OUTPUT B** jacks. You'll need to set things up so that the sound you want to sample is output from the **OUTPUT A (MIX)** jacks.

Sampling mode

- Sampling:[F1 (Sampling)]**

Sample a sound from an external input source.

* Operating the keyboards, pads, sequencer will not play the internal sound generator.

- **Re-Sampling: [F2 (Re-Sampl)]**

Resample the sound of the internal sound generator. The sound of the external input will not be heard.

* *The volume of a phrase that you resample may be less than the volume of the original phrase. If necessary, execute the Normalize command (p. 156) to raise the volume.*

- **Mix Sampling: [F3 (Mix)]**

Sample the combined sounds of the internal sound generator and an external input source.

- **Auto divide sampling: [F4 (Auto Divide)]**

Sample an extended source, and automatically divide it into several samples at silent regions. If the sample contains silence, it will be divided at that point, and the subsequent portion will be assigned to the next sample number.

* *Operating the keyboards, pads or D Beam controllers will not play the internal sound generator.*

- **Solo sampling: [F5 (Solo)]**

While playing the internal sound generator as usual, sample only the sound from the external input.

* *Effects cannot be applied to the external input sound.*



3. Make the settings for things such as the input source of the sound to be sampled, and triggering.

- **Input Select**

Specifies the input source of the sound that is to be sampled.

Value

- DIGITAL IN:** DIGITAL IN connector
- LINE IN L/R:** INPUT jacks L/R (stereo)
- LINE IN L:** INPUT jack L (mono)
- MICROPHONE:** INPUT jack L (mic level)

* *This cannot be set when resampling.*

- **Stereo Switch**

Specifies whether the sound will be sampled in stereo or in monaural. Mono sampling uses half as much memory space.

Value

- MONO:** The sound will be sampled as one wave. If the sound is stereo, the left and right signals will be mixed.
- STEREO:** The sound will be sampled as two waves, L and R.

- **Pre Sample Time**

The length of sound preceding the moment at which sampling was manually or automatically initiated that will be captured in the sample. This lets you prevent the attack portion of the sound from being omitted from the sample.

Value: 0–1000 ms

- **Stop Trigger**

Specifies how sampling will end.

Value

MANUAL: Continue sampling until you press [STOP].

BEAT: Stop sampling after the specified number of beats at the current tempo (BPM).

TIME: Sample the specified length of time.

- **Sampling Length**

You can specify this if Stop Trigger is “BEAT” or “TIME.”

Value

Sampling Length When Stop Trigger is “BEAT”: 1–20000: Number of beats to continue sampling

When Stop Trigger is “TIME”: 00’00”010–50’00”000: length of time to continue sampling.

- **Auto Trigger Level**

Specifies the volume at which sampling will begin if you have pressed [F2 (Auto Trig)] to turn Auto Trig ON.

Value: 0–7 (A setting of 0 is the minimum.)

- **Gap Time**

Specifies the length of the silences at which the sample will be divided if the Sampling Mode is set to Auto Divide. Whenever there is a silent region longer than the specified time, the sample will be divided at that point, and the next sample number will be assigned to the sound that follows.

Value: 500, 1000, 1500, 2000 ms

* *This parameter is valid only when you are using Auto Divide Sampling.*

- **Input Setting: [F1 (INPUT SETTING)]**

Makes settings for the external input (p. 141).

- **Auto Trigger: [F2 (AUTO TRIG)]**

If this is on, sampling will begin automatically when the input sound is detected.

NOTE

Before you turn Auto Trig on, perform steps 4 and 5 to set the input level.

- **Trim Sw: [F3 (TRIM SW)]**

If this is turned on, the Start point and End point settings (p. 149) will be automatically adjusted after sampling is performed, so any silent portions at the beginning or end of the sampled sound are excluded.

4. Play the external input source.

Sampling

- In the EXT SOURCE section of the panel, use LEVEL knob to adjust the input level of the external source.

* If you're using DIGITAL IN, this adjustment is not necessary.



- * If the volume of the external source is too high, the PEAK indicator will light. If this occurs, turn down the LEVEL knob until the PEAK indicator no longer lights.
- * If the level of the sound to be sampled is too high, the word "CLIP" will appear at the right of the level meter in the screen.
- * Using a connection cable that contains a resistor can cause the sound level to be low. Use a connection cable that does not contain a resistor.

- Press [F8 (Start)] to begin sampling.

- If Stop Trigger is set to MANUAL, press [F7 (Stop)] to stop sampling.

The Sample Edit (p. 148) screen will appear.

* If you want to edit the sample, refer to p. 146.



When you finish sampling, the sample will automatically be added to the sample list. Press [SAMPLE LIST] to view the sample list.

Samples you record will be lost when you turn off the power. If you want to keep your sample, press [WRITE] to save it (p. 159). Samples shown as "NEW" in the sample list have not yet been saved.

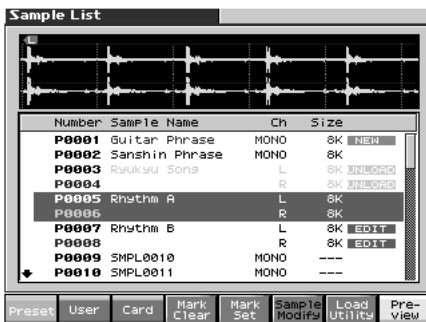

- Press [EXIT] to go back to where you were before you entered the Sampling screen.

Dividing a Sample During Sampling

- During sampling, press [F8 (Divide)].

The sample will be divided at the point where you pressed the button, and the subsequent material will be sampled as a sample of the next number.

* When sampling in mono, you can divide the material into a maximum of 256 samples. When sampling in stereo, you can divide the material into a maximum of 128 samples (L/R total 256 samples).

TIP

Sampling time

The Fantom-X contains 32 MB of memory, which allows about 6 minutes of mono or about 3 minutes of stereo sampling. If you want to sample for a longer time than this, you must install separately sold memory (DIMM) (p. 244, p. 246).

Sampling Earlier in Time (Skip Back Sampling)

Sometimes you may want to preserve a nice phrase that you happened to play a bit earlier. In such cases, you can use the Skip Back Sampling function to sample sounds that were played earlier in time.

When you execute skip-back sampling, several beats of your prior performance are saved as a sample. You can assign this sample to a pad and play it from the pad.

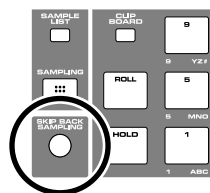

- Button lit:** Skip-back sampling can be performed in this state.
- Button unlit:** Skip-back sampling cannot be performed. Not operating. You cannot use skip-back sampling if there is insufficient free memory.
- Button blinking:** The following screen will appear, and Skip Back Sampling will be executed.

- 1. Play the Fantom-X's keyboard or pads, or connect an instrument or some other device to the AUDIO IN jacks or DIGITAL IN and input sounds or phrases.**
- 2. Press [SKIP BACK SAMPLING].**
The following screen will appear, and Skip Back Sampling will be executed.

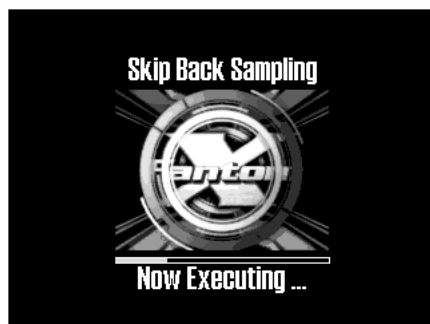

When Skip Back Sampling ends, the Assign to Pad screen will appear. Now you can specify the pad that will play this sound.

- 3. Specify the pad that you want to use; you can either turn the VALUE dial or use [INC] [DEC] to select the pad number, or simply strike the desired pad.**
If you want to time-stretch the sample to match the tempo, press [F1 (Tempo Sync)].

- 4. Press [F8 (Exec)]; now you can play the sample from the pad.**

MEMO

If you want to edit the sampled sound or play it from the keyboard, press [SAMPLE EDIT] to access the Sample Edit screen.

- Press [F3 (Sample Modify)] to edit the sample (p. 155 and following).
- Press [F6 (Assign KB/Pad)] to assign the sample to a keyboard part (p. 152).

MEMO

You can specify how far back sampling will occur when you perform skip-back sampling (5–40 seconds). With the factory settings this is set to 10 seconds.

Samples captured by Skip Back Sampling will be lost when you turn off the power. If you want to keep the sample, perform the Save procedure (p. 159).

Editing a Sample

This section explains how you can edit a sample that you sampled/imported

Editing is performed in sample memory—a memory area dedicated to samples (p. 32).

Selecting a Sample (Sample List)

Select a sample from the list.

Selecting a Sample

1. Press [SAMPLE LIST].

The Sample List display appears.

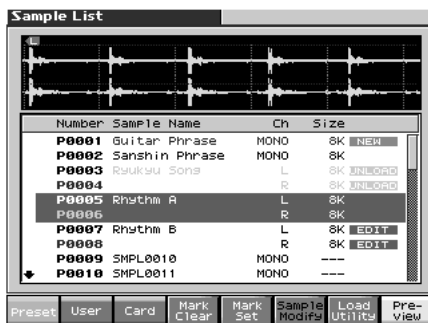

2. Specify the group from which you want to select a sample.

- [F1 (Preset)]: Select from preset samples.
- [F2 (User)]: Select from user samples.
- [F3 (Card)]: Select from samples stored on a memory card.

* You cannot edit preset (Preset) samples.

3. Use VALUE dial, [INC][DEC], or ▲ ▼ to select a sample.

If you hold down [SHIFT] while you operate the above buttons, the sample number will change in steps of ten.

You can press [F8 (Preview)] to audition the selected sample.

4. Press [ENTER].

The Sample Edit Screen appears.

The sample list shows the current state of the samples.



NEW: This is a sample that you sampled. It has not been saved, and will be lost when you turn off the power. The same is true for samples imported as WAV/AIFF.

UNLOAD: The sample has been saved, but not loaded into sample memory.

EDIT: This is a sample that you loaded or sampled and are editing. Your edits will be lost when you turn off the power. If you want to keep them, you must write the sample. Save this data as necessary.

The Fantom-X has a parameter (Load User Samples at Startup, (p. 234)) that specifies whether the samples in user memory, the samples in a memory card, or the preset samples will be automatically loaded into sample memory when you turn on the power. If Load User Samples at Startup is turned off, samples will not be loaded into memory when you turn on the power. In this case, you will need to load samples into memory yourself. If you have unload a sample from sample memory, you will also need to load it again before you can re-select that sample.

Loading a Sample

Here's how you can load a sample from the user area, a memory card, or a preset into sample memory.

- 1. Press [SAMPLE LIST].**
The Sample List display appears.
 - 2. From [F1 (Preset)]–[F3 (Card)], select the bank that contains the desired sample.**
 - 3. Use VALUE dial, [INC][DEC], or ▲ ▼ to select a sample.**
If you want to load two or more samples, press [F5 (Mark Set)] to add a check mark (✓) to the samples that you want to select. To remove the check mark, press [F4 (Mark Clear)].
If you hold down [SHIFT] and press [F5 (Mark Set All)], a check mark will be added to all samples of the selected bank. If you hold down [SHIFT] and press [F4 (Mark Clr All)], check marks will be removed from all selected samples.
The edit screen for the selected sample will appear.
 - 4. Press [F7 (Load Utility)], and then press [F7 (Load)].**
A message will ask you for confirmation.
 - 5. Press [F8 (Exec)] to load the sample.**
To cancel, press [F7 (Cancel)].
- * You can also perform this operation from the Sample Edit or Sample List screen by pressing [MENU] and selecting Load Sample.

Loading all Samples

Here's all samples in the user memory and memory card can be loaded.

NOTE

When you execute Load All Samples, all unsaved samples will be erased.

NOTE

If the total size of the data in the user bank and card bank exceeds the size of memory, the samples of the user bank will be loaded first. At this time, as many card bank samples as possible will be loaded, starting from the lowest-numbered sample.

- 1. From the Sample List screen or Sample Edit Screen (p. 148), press [MENU].**
 - 2. Press ▲ or ▼ to select "Load All Samples," and then press [ENTER].**
A message will ask you for confirmation.
- * If you press [SAVE/LOAD] and then press [F7 (Load All Smpl)] instead of performing steps 1–2, the same confirmation message will appear.
- 3. Press [F8 (Exec)] to execute.**
To cancel, press [F7 (Cancel)].
- * You can also perform this operation from the Sample Edit or Sample List screen by pressing [MENU] and selecting Load All Samples.

Unloading a Sample

Here's how you can unload a sample from sample memory. The saved sample file itself will not be deleted.

- 1. With the Sample List screen shown, choose [F1 (Preset)]–[F3 (Card)] to select the group that contains the sample you want to erase.**
 - 2. Use VALUE dial, [INC][DEC], or ▲ ▼ to select a sample.**
If you want to erase two or more samples, press [F5 (Mark Set)] to add a check mark (✓) to the samples that you want to select. To remove the check mark, press [F4 (Mark Clear)].
If you hold down [SHIFT] and press [F5 (Mark Set All)], a check mark will be added to all samples of the selected bank. If you hold down [SHIFT] and press [F4 (Mark Clr All)], check marks will be removed from all selected samples.
The edit screen for the selected sample will appear.
You can press [F8 (Preview)] to audition the selected sample.
 - 3. Press [F7 (Load Utility)], and the press [F6 (Unload)].**
A message will ask you for confirmation.
 - 4. Press [F8 (Exec)] to unload the sample.**
To cancel, press [F7 (Cancel)].
- * You can also perform this operation from the Sample Edit screen by pressing [MENU] and selecting Unload Sample.

Deleting a Sample

Here's how to completely delete a sample file.

* You cannot delete the preset samples.

- 1. With the Sample List screen shown, choose [F2 (User)]–[F3 (Card)] to select the group that contains the sample you want to delete.**
 - 2. Turn the VALUE dial, or press ▲ or ▼ to select the sample.**
If you want to delete two or more samples, press [F5 (Mark Set)] to add a check mark (✓) to the samples that you want to select. To remove the check mark, press [F4 (Mark Clear)].
If you hold down [SHIFT] and press [F5 (Mark Set All)], a check mark will be added to all samples of the selected bank. If you hold down [SHIFT] and press [F4 (Mark Clr All)], check marks will be removed from all selected samples.
The edit screen for the selected sample will appear.
You can press [F8 (Preview)] to audition the selected sample.
 - 3. Press [F7 (Load Utility)], and the press [F5 (Delete Sample)].**
A message will ask you for confirmation.
 - 4. Press [F8 (Exec)] to delete the sample.**
To cancel, press [F7 (Cancel)].
- * You can also perform this operation from the Sample Edit or Sample List screen by pressing [MENU] and selecting Delete Sample File.

Editing a Sample

Importing an Audio File

Here's how an audio file (WAV/AIFF) can be loaded into memory as a sample.

NOTE

Place the audio files in the "TMP/AUDIO_IMPORT" folder on the user memory or memory card. For details on how you can use your computer to copy a file into the user area or memory card, refer to p. 218.

1. From the Sample List screen or Sample Edit screen (p. 148), press [MENU] to select "Import Audio," and then press [ENTER].

* You can obtain the same result by pressing [SAVE/LOAD] and then pressing [F8 (Import Audio)] instead of performing step 1.

2. Press [F1 (User)] or [F2 (Card)] to select the import-source area.

User: Select a file from the user area.

Card: Select a file from the memory card.

3. Use [CURSOR] to move the cursor to the "TMP/AUDIO_IMPORT."

4. Press ▲ or ▼, then select the file that you want to import.

If you want to select two or more samples, press [F5 (Mark Set)] to add a check mark (✓) to the files that you want to select. To remove the check mark, press [F4 (Mark Clear)].

If you hold down [SHIFT] and press [F5 (Mark Set All)], a check mark will be added to all files of the selected folder. If you hold down [SHIFT] and press [F4 (Mark Clr All)], check marks will be removed from all selected files.

5. Press [F8 (Import Audio)].

A message will ask you for confirmation.

* To cancel, press [F7 (Cancel)].

6. Press [F8 (Exec)].

The file will be imported, and the Sample List screen will appear.

* To cancel, press [F7 (Cancel)].

MEMO

The imported file will be added to the sample list as a sample. This sample is temporary, and will be lost when you turn off the power. If you want to keep it, press [WRITE] to save the data (p. 159).

Displaying Sample Edit Screen

1. When you press [SAMPLE EDIT] in the sampling section. The Sample Edit screen will appear.

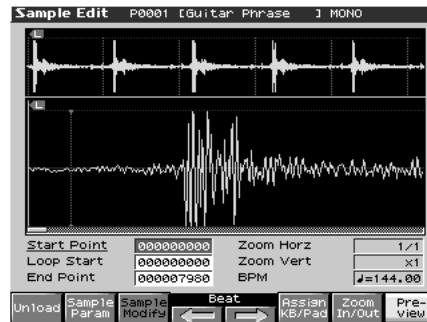

NOTE

Samples that you edit will be lost when you turn off the power. If you want to keep them, you must Save them (p. 159).

Magnifying/Shrinking the Waveform Display (Zoom In/Out)

Here's how to change the magnification of the sample display.

1. In the Sample Edit screen, press [F7 (Zoom In/Out)]. The Zoom In/Out sub-window will appear.

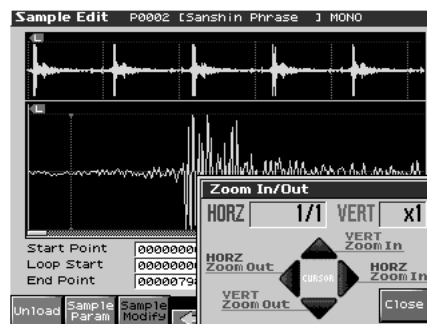

2. Use [CURSOR] to change the magnification of the display.
 - Horizontal axis (time axis): 1/1–1/65536
Press ► to increase the display magnification.
Press ◀ to decrease the display magnification.
 - * Either turn the VALUE dial or use [INC], [DEC] to adjust this setting.
 - Vertical axis (waveform amplitude axis): x1–x128
Press ▲ to increase the display magnification.
Press ▼ to decrease the display magnification.
3. Press [F8 (Close)] to close the sub-window.

Even without displaying the Zoom In/Out sub-window, you can press CURSOR ◀ ► to expand/shrink the horizontal axis, or hold down [SHIFT] and press CURSOR ▲ ▼ to expand/shrink the vertical axis.

Setting the Start/End Points of the Sample

You can specify the portion of the sample that will actually sound. You can also specify the region that is to be looped.

1. Press [SAMPLE LIST] and select the sample that you want to edit (p. 146).
2. Press [SAMPLE EDIT].



* For details on how to select a sample, refer to Sample List (p. 146).

3. Use ▲ or ▼ to select the point that you want to set.
 - **Start Point:**
This is the point at which playback will start. Set this so that any unwanted portion at the beginning of the sample will be skipped, and the sound will begin at the desired moment.
 - **Loop Start:**
This is the point at which loop playback (second and subsequent times) will start. Set this if you want to loop the sound from a point other than the start point.
 - **End Point:**
This is the point at which playback will end. Set this so that any unwanted portion at the end of the sample will not be heard.

MEMO

By pressing [F8 (Preview)] you can audition the region between the start point and edit point.

MEMO

If you hold down [F8 (Preview)] and edit the start/loop/end point, the sample will play repeatedly across that point. Since the sound in the region you're specifying will play repeatedly, this is a convenient way to check your setting. (Zooming-in or zooming-out on the waveform will change the region that loops.)

4. Either turn the VALUE dial or use [INC], [DEC] to move the point so it's where you want it to be.
You'll probably find it convenient to zoom-in when making fine adjustments, and zoom-out when making major adjustments (p. 148).
You can move the point in units of one beat by pressing [F4 (←)] or [F5 (⇒)].

NOTE

The preset samples cannot be moved by beat.

MEMO

After specifying the start point and end point, you can execute Truncate (p. 155) to delete unwanted portions at the beginning and end of the sample.

About the beat

Samples contain beat data. Up to 100 beat locations are specified for one sample. If the sample contains more than 100 beats, fifty beat locations will be specified from the beginning and end of the sample, respectively.

* The preset samples do not contain beat data.

When you want to reset the beat indication (Reset Grid function)

You can reassign the sample grid according to the specified start point and BPM. In the Sample Edit screen, specify the start point of the sample and press [F2 (Sample Param)] to access the Sample Prm screen. In the Sample Prm screen, specify the BPM and press [F7 (Reset Grid)]. To execute, press [F8 (Exec)].

NOTE

Sample modify operations (Chop, Normalize, etc.) apply to the entire sample. Even if you specify a start point or end point, they will be ignored. If you want to apply the operation only to the region between the start point and end point, use Truncate to delete unwanted portions of the sample, and then perform the sample modifying operation.

Using the knobs to edit the points

You can use the knobs to edit each point. Using the knobs is convenient when you need to make large changes to the value.

1. Make sure that the button indicators located at the right of the REALTIME CONTROL knobs are extinguished. If they are lit, press the button so the indicators go out.
2. Use the REALTIME CONTROL knobs to specify the following editing points.
From the left, the knobs have the following functions.



- 1 : Start Point
- 2 : Loop Start
- 3 : End Point
- 4 : Zoom-in/zoom-out the horizontal axis of the display

Making Settings for Sample (Sample Parameters)

Here you can make various settings for the sample.

1. Press [SAMPLE LIST] and select the sample that you want to edit (p. 146).
2. Press [SAMPLE EDIT] to access the Sample Edit screen, and press [F2 (Sample Param)].



3. Press ▲ or ▼ to select a parameter.
4. Use VALUE dial or [INC], [DEC] to edit the value.

- **Loop Mode**

Specifies how the sample will be played.

Value

FWD (Forward)

After the Sample played back from the Start point to the End point, it will then be repeatedly played back in the forward direction, from the Loop Start point to the End point.

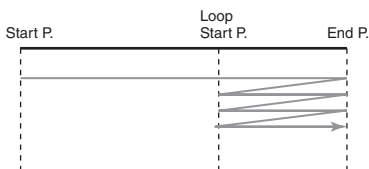

ONE-SHOT

The sample will be played back only once, from the Start point to the End point.

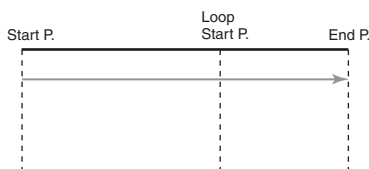

REV (Reverse)

When the sample has been played back from the End point to the Start point, it will be repeatedly played back in the reverse direction, from the Loop Start point to the Start point.

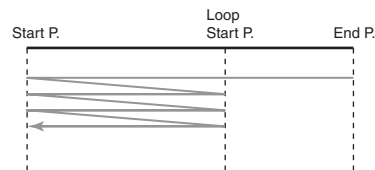

REV-ONE (Reverse One-shot)

The sample will be played back only once from the End point to the Start point in the reverse direction.

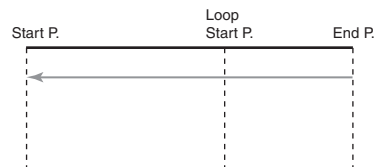

- **Loop Tune**

Specifies the pitch of the loop region.

Value: -50– +50

* Make fine adjustments in one-cent (1/100 semitone) increments.

- **Original Key**

Note number that will play the sample at the pitch at which it was sampled.

Value: 0 (C-1)–127 (G9)

- **BPM (TEMPO)**

Specifies the original tempo of the sample.

Value: 5.00–300.00

* In order to synchronize the tempo, Wave Temp Sync (p. 63) must be turned on.

* When setting the BPM (tempo) value, you can hold down [SHIFT] and turn the VALUE dial, or use [INC] [DEC] to adjust the value to the right of the decimal point.

- **Time Stretch Type**

Specifies how the tempo will be synchronized. Decreasing this value will optimize the sound for more rapid phrases, and increasing this value will optimize the sound for slower phrases.

Value: TYPE01–TYPE10

- **Start Fine**

Fine adjustment of the Start point.

Value: 0–255

- **Loop Start Fine**

Fine adjustment of the Loop Start point.

Value: 0–255

- **Loop End Fine**

Fine adjustment of the End point.

Value: 0–255

* By pressing [F7 (Reset Grid)] you can reassign the sample grid according to the specified start point and BPM. To execute, press [F8 (Exec)].

5. Press [EXIT] when you are finished.

Assigning Samples to a Pad (Assign To Pad)

Here's how to assign samples as the rhythm tones of a rhythm set. For example, you can create an original rhythm set by replacing certain tones of a preset rhythm set with different samples.

- * From the Sample List screen you can also press [F7 (Load Utility)]-> [F2 (Assign to Pad)] to execute Assign To Pad.
- * You cannot execute this with more than one sample selected.

From Patch Mode

1. Press [SAMPLE LIST] to select a sample, and then press [SAMPLE EDIT] to access the Sample Edit screen.

2. Press [F6 (Assign KB/Pad)].

The Assign to Kbd/Pad screen will appear.



3. Press [F7 (Assign to Pad)].

The Assign to Pad screen will appear.

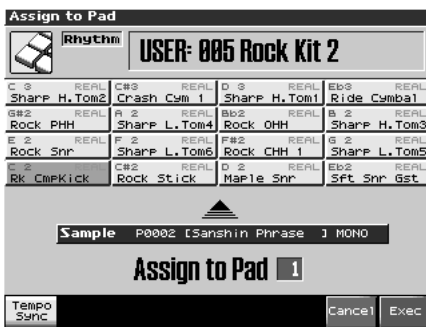

4. Select the desired pad by pressing it directly.

If you press [F1 (Tempo Sync)] to light it into red, the Wave Tempo Sync parameter (p. 89) will be turned ON for the rhythm tone that is assigned.

5. Press [F8 (Exec)].

A message will ask your confirmation.

6. Press [F8 (Exec)] to execute Assign to Pad.

The sample will be assigned (as a rhythm tone) to the specified pad.

To cancel, press [F7 (Cancel)].

7. Press [EXIT] to return to the previous screen.

From Performance Mode

Before you continue with the procedure below, make sure you're in Performance mode, and select the patch or rhythm set to which you want to assign the sample.

1. Press [SAMPLE LIST] to select a sample, and then press [SAMPLE EDIT] to access the Sample Edit screen.

2. Press [F6 (Assign KB/Pad)].

The Assign to Kbd/Pad screen will appear.

3. Press [F7 (Assign to Pad)].

The Assign to Pad screen will appear.

If a rhythm set is not assigned to the selected part, a message will ask "Change into Rhythm and Initialize?", asking if you want to assign an initialized rhythm set to the selected part.

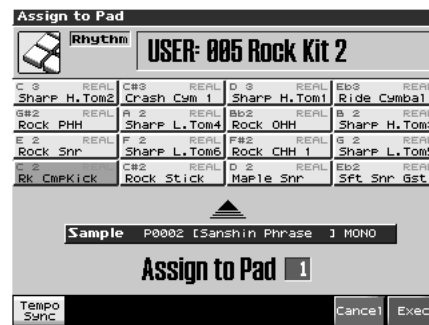

4. Select the desired pad by pressing it directly.

If you press [F1 (Tempo Sync)] to light it into red, the Wave Tempo Sync parameter (p. 63) will be turned ON for the rhythm tone that is assigned.

5. Press [F8 (Exec)].

A message will ask your confirmation.

6. Press [F8 (Exec)] to execute Assign to Pad.

The sample will be assigned (as a rhythm tone) to the specified pad.

To cancel, press [F7 (Cancel)].

7. Press [EXIT] to return to the previous screen.

NOTE

If you select another rhythm set, the rhythm set you assigned will be replaced by that patch. If you want to keep the patch you created, press [WRITE] and save it.

Editing a Sample

Assigning a Sample as a Patch to a Part (Assign to Keyboard)

Here's how you can use the currently selected sample to create a patch, and assign it to a keyboard part.

- * From the Sample List screen you can also press [F7 (Load Utility)]-> [F2 (Assign to Pad)] to execute Assign To Pad.
- * You cannot execute this with more than one sample selected.

From Patch Mode

1. Press [SAMPLE LIST] to select a sample, and then press [SAMPLE EDIT] to access the Sample Edit screen.
2. Press [F6 (Assign KB/Pad)].
Assign to Kbd/Pad window appears.



3. Press [F6 (Assign to Kbd)].
The Assign to Keyboard window will appear, and you can verify the assignment for the keyboard part.
If you press [F2 (Tempo Sync)] to turn it into red, the Wave Tempo Sync parameter (p. 63) will be turned ON for the patch that is assigned.
4. Press [F8 (Exec)].
A message will ask you for confirmation.
5. Press [F8 (Exec)].
The sample will be assigned (as a patch) to the specified keyboard part.
To cancel, press [F7 (Cancel)].

From Performance Mode

1. Press [SAMPLE LIST] to select a sample, and then press [SAMPLE EDIT] to access the Sample Edit screen.
2. Press [F6 (Assign KB/Pad)].
Assign to Kbd/Pad window appears.



3. Press [F6 (Assign to Kbd)].
Assign to Keyboard window appears.

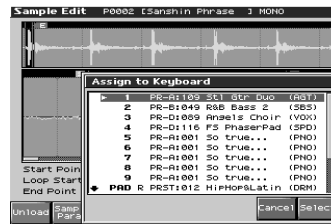

4. Press ▲ or ▼ to specify the part to which the new patch is to be assigned, and then press [F8 (Select)].
The Assign to Keyboard window will appear, and you can verify the assignment for the part.
If you press [F2 (Tempo Sync)] to turn it into red, the Wave Tempo Sync parameter (p. 63) will be turned ON for the patch that is assigned.
5. Press [F8 (Exec)].
A message will ask you for confirmation.
6. Press [F8 (Exec)].
The sample will be assigned (as a patch) to the specified part.
To cancel, press [F7 (Cancel)].
7. Press [EXIT] to return to the previous screen.

NOTE

If you select another patch, the patch you assigned will be replaced by that patch. If you want to keep the patch you created, press [WRITE] and save it.

Create a Rhythm Set (Create Rhythm)

Here's how you can use the sample(s) to create a rhythm set. This operation is called **Create Rhythm**.
When you execute Create Rhythm, the sample(s) will become a rhythm set and will be assigned to a part.
For example, you could record a sample, use the Chop function to divide it, and then use this Create Rhythm operation to assign the divided samples to a part as a rhythm set. Alternatively, you can assign a mark to two or more samples in the sample list, and execute Create Rhythm to assign the samples to a part as a rhythm set.
The samples will be assigned consecutively from the C2 key.

1. Press [SAMPLE LIST] to access the Sample List screen.
2. Select the samples.
If you want to select two or more samples, press [F5 (Mark Set)] to add a check mark (✓) to the samples that you want to select.
To remove the check mark, press [F4 (Mark Clear)].
You can press [F8 (Preview)] to audition the selected sample.

- Press [F7 (Load Utility)], and then press [F4 (Create Rhythm)].

The Create Rhythm window will appear.

Patch Mode



Performance Mode

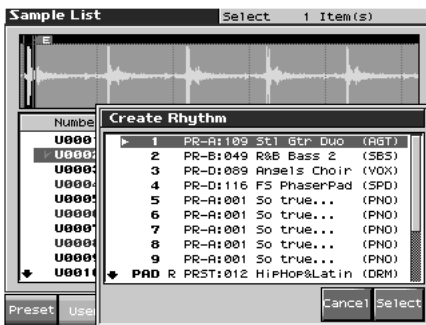

- Either turn the VALUE dial or use [INC] [DEC] to select the part that you want to assign.

- Press [F8 (Select)].

The Create Rhythm window will appear.

If you press [F1 (Tempo Sync)] to light it into red, the Wave Tempo Sync parameter (p. 89) will be turned ON for the rhythm tone that is assigned.



- Press [F8 (Exec)].

The sample will be assigned (as a patch) to the specified part. To cancel, press [F7 (Cancel)].

- Press [EXIT] to return to the previous screen.

* If you select another rhythm set, the rhythm set you assigned will be replaced by that rhythm set. If you want to keep the rhythm set, press [WRITE] and save it.

* The sounds will be assigned in order starting at the C2 key.

Creating a Multisample (Create Multisample)

Two or more samples assigned to different keys are collectively called a "multisample." One multisample can assign up to 128 samples divided ("split") across the notes of the keyboard. A memory card can store 128 multisamples.

In order to hear a multisample, you'll need to assign it to a Part as a Patch. Choose the desired samples to create the multisample, and then assign it as a patch to a keyboard part for use.

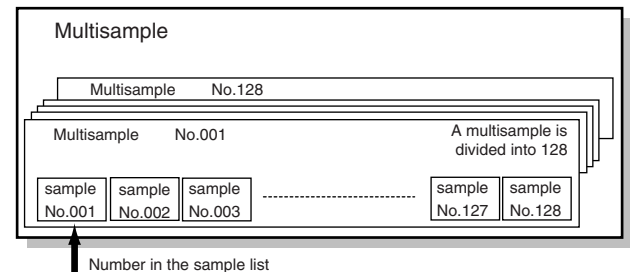

If, for example, only one note (e.g., the sound of the C4 key) is sampled from a wide-ranging instrument such as a piano, and assigned to the entire range of keys, it will sound unnatural when played significantly below or above its original pitch. If the instrument is sampled at several different pitches and assigned to different ranges of the keyboard, this unnatural effect can be minimized.

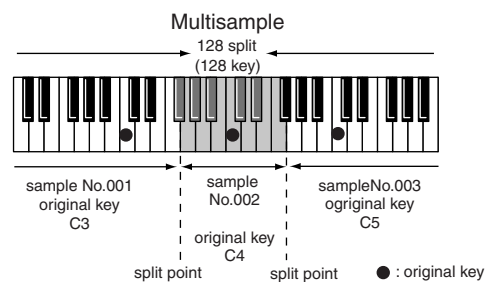

When you create a multisample, the split points are automatically determined according to the original key of each sample. Before you begin this process, you should set the original key of each sample to the range where you want it to be assigned. ("Assigning a multisample to the desired keys" (p. 154))

A sample will not sound at a pitch higher than one octave above the original key.

Editing a Sample

1. Press [SAMPLE LIST] to access the Sample List screen, and select the sample(s) that you want to include in your new multisample.

If you want to select two or more samples from the sample list, press [F5 (Mark Set)] to add a check mark (✓) to each sample.

Pressing [F4 (Mark Clear)] will clear the check mark.

You can press [F8 (Preview)] to audition the selected sample.

If the total number of marks exceeds 128, the multisample will be created from the 128 lowest-numbered samples.

You cannot create a multisample using samples from more than one group.

2. Press [F7 (Load Utility)], and then press [F3 (Create Multi Sample)].

The Create Multisample Name screen will appear.

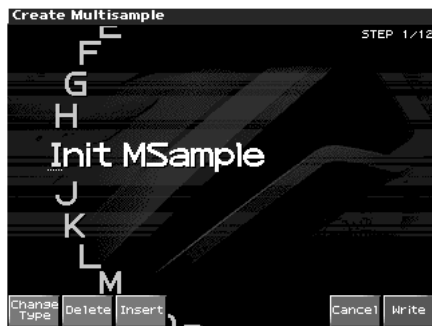

3. Assign a name.

cf.

For details on assigning names, refer to “Assigning a Name” (p. 36)

4. When you have finished inputting the name, press [F8 (Write)].

A screen will appear, allowing you to select the destination for the write.

5. Either turn the VALUE dial or use [INC] [DEC] to select the write destination.

Multisamples consisting of user samples will be written to User, and multisamples consisting of card samples will be written to Card.

6. Press [F8 (Write)].

A message will ask you to confirm the operation.

7. If you are sure you want to write the multisample, press [F8 (Exec)].

If you decide to cancel, press [F7 (Cancel)].

Never switch off the Fantom-X while data is being saved.

8. When the data has been written, the Assign to Keyboard screen will appear.

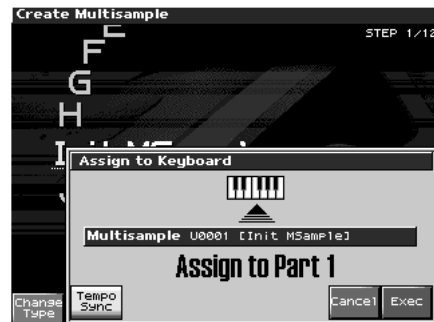

9. If you want to use the multisample as a patch, press [F8 (Exec)].

If you decide to cancel, press [F7 (Cancel)].

Never turn off the power while data is being written.

- * You can't listen to a multisample unless it's assigned to a part as a patch. If you press [F7 (Cancel)] at this point, the multisample will be saved, but you'll need to perform the additional step of assigning the saved multisample to the keyboard in order to actually play it (p. 152).

Assigning a multisample to the desired keys

In order to assign a multisample to the desired keys, you'll need to set the Original Key of each sample to the appropriate keys. Then, when you execute the Create Multisample operation, the Fantom-X will assign the samples to the keyboard and set the split points automatically.

1. Press [SAMPLE LIST] to access the Sample List screen, and select one of the samples within the multisample.

2. Press the [SAMPLE EDIT] button to access the Sample Edit screen.

3. Press [F2 (Sample Param)] to access the Sample Param screen.

4. Set the Original Key to the note number of the key to which you want to assign the sample.

MEMO

You can also specify a note number by playing a note on the keyboard.

5. Press the [SAMPLE EDIT] button to return to the Sample Edit screen, and set the Original Key for the other samples in the same way.

MEMO

When creating a multisample, you'll need to change the Original Key of more than one sample. After you've made the setting for the first sample, you can simply press [SAMPLE LIST] to access the Sample List screen, select another sample and press [ENTER] to go directly to the Sample Param screen.

- * The Original Key you specify here needs to be saved for each sample.

- When you've finished setting the Original Key of all samples, create the multisample as described in "Creating a Multisample (Create Multisample)" (p. 153).

Unloading a Sample (Unload)

In the Sample Edit screen you can press [F1 (Unload)] to unload the currently selected sample and return to the previous screen.

Removing Unwanted Portions of a Sample (Truncate)

This operation cuts the portions of the sample that are earlier than the Start Point and later than the Loop End Point.

* You cannot execute this with more than one sample selected.

- Press [SAMPLE EDIT] to access the Sample Edit screen.
- Press ▲ or ▼ to select the parameter.
 - Start Point:** Specifies the sample start point.
 - End Point:** Specifies the sample end point.
- Either turn the VALUE dial or use [INC] [DEC] to set the value.
- Press [F3 (Sample Modify)] to access the Sample Modify window.
- Press [F1 (Truncate)].



- If you want to replace the current sample with the truncated sample, press [F6 (Over Write)] to display the "✓" symbol.
- Press [F8 (Exec)].
A message will ask you for confirmation.
- To execute the Truncate operation, press [F8 (Exec)].

* If you want to cancel without executing, press [F7 (Cancel)].

Boosting or Limiting the High-frequency Range of the Sample (Emphasis)

In some cases, the audio quality will be improved if you boost the high-frequency range of an imported sample. Also, the high-frequency range of the sample may be emphasized when you use a sampler made by another manufacturer. In this case, you can minimize the change in tonal character by attenuating the high-frequency range.

* You cannot execute this with more than one sample selected.

- Press [SAMPLE EDIT] to access the Sample Edit screen.
- Press [F3 (Sample Modify)] to access the Sample Modify window.
- Press [F2 (Emphasis)].



- Either turn the VALUE dial or use [INC] [DEC] to select the emphasis type.
 - PreEmphasis:** Emphasizes the high-frequency range.
 - DeEmphasis:** Attenuates the high-frequency range.
- If you want to replace the current sample with the emphasized sample, press [F6 (Over Write)] to display the "✓" symbol.
- Press [F8 (Exec)].
A message will ask you for confirmation.
- To execute, press [F8 (Exec)].

* To cancel, press [F7 (Cancel)].

Maximizing the Volume of a Sample (Normalize)

This operation raises the level of the entire sample as much as possible without exceeding the maximum level. In some cases, the volume of a phrase you resampled (p. 143) will be lower than the volume of the original phrase. In this case, it is a good idea to boost the volume by executing the Normalize operation.

* You cannot execute this with more than one sample selected.

1. Press [SAMPLE EDIT] to access the Sample Edit screen.
2. Press [F3 (Sample Modify)] to access the Sample Modify window.
3. Press [F3 (Normalize)].



4. If you want to replace the current sample with the normalized sample, press [F6 (Over Write)] to display the “✓” symbol.
5. Press [F8 (Exec)].
A message will ask you for confirmation.
6. To execute, press [F8 (Exec)].

* To cancel, press [F7 (Cancel)].

Amp

This operation applies an envelope (time-variant change) to the volume of the sample. You can also adjust the volume of the entire sample.

* You cannot execute this with more than one sample selected.

1. Press [SAMPLE EDIT] to access the Sample Edit screen.
2. Press [F3 (Sample Modify)] to access the Sample Modify window.

3. Press [F4 (Amp)].



4. Use VALUE dial or [INC] [DEC] to set the value.
 - **Rate 1–4:** Specifies the rate of volume boost.
This specifies how much boost will be applied relative to the current volume. The entire sample you select will be boosted.
Value: 0–400%
5. If you want to specify a point, press [F5 (Point)] to light it into red. Press ▲ or ▼ to select a parameter, and then use VALUE dial or [INC] [DEC] to set the value.
 - **Current Point:** Specifies the currently selected point. Beginning near the start point, the points will be numbered 1, 2, 3, or 4.
 - **Point 1–4:** Location of the current point
 - **Rate 1–4:** Amplification ratio of the current point
Specifies how the volume of each point is to be boosted relative to the current value.
Value: 0–400%
6. If you want the edited sample to replace the current sample, press [F6 (Over Write)] to display the “✓” mark.
7. Press [F8 (Exec)].
A message will ask you for confirmation.
8. To execute, press [F8 (Exec)].
* To cancel, press [F7 (Cancel)].

Stretching or Shrinking a Sample (Time Stretch)

This operation stretches or shrinks the sample to modify the length or tempo. You can stretch or shrink the sample by a factor of one half to double the original length.

* You cannot execute this with more than one sample selected.

1. Press [SAMPLE EDIT] to access the Sample Edit screen.
2. Press [F3 (Sample Modify)] to access the Sample Modify window.

3. Press [F5 (Time Strch)].



4. Press ▲ or ▼ to select the parameter.

• Edit Time Stretch

- BPM:** Change the BPM of the sample to the BPM you specify.
- Time:** Specify the length of the sample as a time value.
- Rate:** Specify the length relative to the current length of the sample.
- Value:** 50.0–200.0%

• Type

Lower settings of this value will make the sound more suitable for faster phrases, and higher settings will make the sound more suitable for slower phrases.

Value: TYPE01–TYPE10

• Quality Adjust

Make fine adjustments to the tonal quality of the Time Stretch.

Value: 1–10

5. Use VALUE dial or [INC/DEC] to specify the tempo/length.

When setting the BPM (tempo) value, you can hold down [SHIFT] and turn the VALUE dial, or use [INC] [DEC] to adjust the value to the right of the decimal point.

6. Press [F8 (Exec)].

A message will ask you for confirmation.

7. To execute, press [F8 (Exec)].

The length of the sample will be changed as specified.

* To cancel, press [F7 (Cancel)].

Dividing a Sample into Notes (Chop)

The **chop** function divides a sample waveform into separate notes.

* The *Create Rhythm* function (p. 152) makes it easy to create a rhythm set from a chopped sample.

* You cannot execute this with more than one sample selected.

1. Press [SAMPLE EDIT] to access the Sample Edit screen.

2. Press [F3 (Sample Modify)] to access the Sample Modify window.

3. Press [F3 (Chop)].



Procedure for Dividing a Sample

You can freely specify the point(s) at which the sample is to be divided.

4. Press ▲ or ▼ to move the cursor to “Current Address.”

5. Either turn the VALUE dial or use [INC], [DEC] to move the point.

6. At the location where you want to divide the sample, press [F4 (Add Point)].

The current location will be the dividing point.

7. Repeat steps 5 and 6 to specify other dividing points as desired.

You can specify up to 15 locations at which to divide the sample; i.e., the sample will be divided into a maximum of 16 pieces.

8. Audition the sample as described in the section “Auditioning the divided samples.”

If you want to re-make settings, press [F7 (Cancel)], and move or delete the point (p. 158).

9. Press [F8 (Exec)].

A message will ask you for confirmation.

10. To execute the division, press [F8 (Exec)].

* To cancel, press [F7 (Cancel)].

When you execute the Chop operation, a message will ask whether you want to execute Create Rhythm.

* The divided samples will be added to the sample list.

11. If you want to execute Create Rhythm, press [F8 (Exec)].

For the rest of the procedure, refer to “Create a Rhythm Set (Create Rhythm)” (p. 152).

12. If you don’t want to execute Create Rhythm, press [F7 (Cancel)].

Automatically Dividing a Sample (Auto Chop)

Here's how you can automatically specify the points at which the sample is to be divided, and then divide the sample.

1. **From step 3 of p. 157, press [F6 (Auto Chop)].**
The Auto Chop sub-window will appear.
2. **Either turn the VALUE dial or use [INC] [DEC] to select the method by which the sample is to be divided.**
 - **Chop Type**
Specify how the sample will be divided.
Value
Level: Divide according to volume.
Beat: Divide at beats based on the BPM (p. 150) of the sample.
Divide x: Divide into 'x' number of equal lengths.
3. **Press ▼ .**
4. **Either turn the VALUE dial or use [INC] [DEC] to set the value.**
 - **Level (If Chop Type is Level)**
Level at which the sample is to be divided. Lower settings of this value will cause the sample to be divided more finely.
Value: 1–10
 - **Beat (If Chop Type is Beat)**
Beat interval at which the sample is to be divided.
Value: 1/32, 1/16T, 1/16, 1/8T, 1/8, 1/4T, 1/4, 1/2, 1/1, 2, 1
 - **Times (If Chop Type is Divide x)**
Number of samples into which the sample is to be divided
Value: 2–16
5. **Press [F8 (Exec)].**
The sample will be automatically divided according to your settings, and the points will be specified. A maximum of 15 division points will be set (16 regions).
To cancel, press [F7 (Cancel)].
6. **Audition the sample as described in the section “Automatically Dividing a Sample (Auto Chop)” (p. 158)**
If you want to re-make settings, press [F7 (Cancel)], and move or delete the point “Moving a Dividing Point” (p. 158).
7. **Press [F8 (Exec)].**
A message will ask you for confirmation.
8. **To execute the division, press [F8 (Exec)].**
 - * *To cancel, press [F7 (Cancel)].*
When you execute Auto Chop, a message will ask you whether you want to execute Create Rhythm.
9. **If you want to execute Create Rhythm, press [F8 (Exec)].**
For the rest of the procedure, refer to “Create a Rhythm Set (Create Rhythm)” (p. 152).
 - * *The divided samples will be added to the sample list.*

10. **If you don't want to execute Create Rhythm, press [F7 (Cancel)].**
You will return to the Sample Edit screen.

Auditioning the Divided Samples

After dividing the sample, you can press the pads to audition each of the divided samples.

From the sample nearest to the start point, the samples will be played by pads [1], [2],...[16]

Moving a Dividing Point

1. **Press ▲ or ▼ to move the cursor to “Point No.”**
2. **Turn VALUE dial to select the point that you want to move.**
In order from the start point, the points are numbered 1, 2,...15.
3. **Press ▼ .**
4. **Turn VALUE dial to move the dividing point.**

Deleting a Dividing Point

1. **Press ▲ or ▼ to move the cursor to “Point No.”**
2. **Turn VALUE dial to select the point that you want to delete.**
3. **Press [F5 (Clear Point)].**
The dividing point will be deleted.

Joining Two or More Samples (Combine)

This operation combines multiple samples into a single sample. You can combine as many as sixteen samples. You can also place silent spaces between the samples.

1. **Press [SAMPLE EDIT] to access the Sample Edit screen.**
2. **Press [F3 (Sample Modify)] to access the Sample Modify window.**
3. **Press [F7 (Combine)].**



4. Either turn the VALUE dial or use [INC][DEC] to set the value.

- **1–16:** The sample or silence to be combined
- **TYPE**

Value

Sample: sample, **Time:** silent region (specified as time), **Beat:** silent region (specified as a note value)

- **BANK** (Bank that contains the sample)

Value U: user, **C:** card

* This will be displayed only if TYPE is set to Sample.

- **PRM** (Sample number, or the duration/note value of the silent region)

Value: 1–10000 ms (if TYPE is set to Time), note value: 1/32, 1/16T, 1/16, 1/8T, 1/8, 1/4T, 1/4, 1/2, 1/1, 2/1 (if TYPE is set to Beat)

The note value is based on the BPM of the sample immediately before the silent region.

* If there is no sample immediately before the silent region, the current BPM will be used.

5. Use [CURSOR] to select a parameter and repeat step 4.

You can press [F6 (Preview)] to audition the selected sample.

6. Press [F6 (Exec)].

A message will ask you for confirmation.

7. To execute, press [F8 (Exec)].

* To cancel, press [F7 (Cancel)].

Saving a Sample

A newly loaded sample, as well as any changes you've made in the settings for a sample will be lost as soon as you turn off the power. If you want to keep such data, you must save it as follows.

1. Press [SAMPLE EDIT].

2. Press [F1 (Sample List)].

Samples displayed as "NEW" or "EDIT" have not yet been saved.

3. Select the sample that you want to save.

If you want to select two or more samples, press [F5 (Mark Set)] to add a check mark (✓) to the samples that you want to select.

To remove the check mark, press [F4 (Mark Clear)].

If you hold down [SHIFT] and press [F5 (Mark Set All)], a check mark will be added to all samples of the selected bank. If you hold down [SHIFT] and press [F4 (Mark Clr All)], check marks will be removed from all selected samples.

The edit screen for the selected sample will appear.

You can press [F8 (Preview)] to audition the selected sample.

4. Press [WRITE].

The Write Menu screen will appear. Make sure that "Sample" is highlighted.

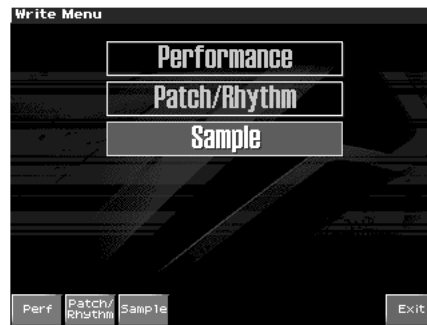

5. Press [F3 (Sample)] or [ENTER].



If you have selected more than one sample, a message will ask you to confirm the writing operation. Samples will be written into the identical number corresponding to each bank of the sample list. Sample names will be assigned automatically. If you want to write the samples, press [F8 (Exec)]. If you decide to cancel, press [F7 (Cancel)].

6. Assign a name to the sample.



For details on assigning names, refer to "Assigning a Name" (p. 36)

7. When you have finished inputting the name, press [F8 (Write)].

A screen will appear allowing you to select the write-destination sample.

8. Turn the VALUE dial, or use [INC][DEC] or [F2 (User)][F3 (Card)] to select the write destination and sample number.

The write destination can be either the Fantom-X's internal user memory (User), or a memory card (Card).

9. Press [F8 (Write)].

A message will ask you for confirmation. Never switch off the Fantom-X while data is being saved.

10. Press [F8 (Exec)] to execute the save operation.

* To cancel the operation, press [F7 (Cancel)].

- You can't save by overwriting another sample.
- Stereo samples must be saved to two consecutive sample numbers.

Using the Pads

The pads of the Fantom-X function in the same way as the keyboard, and can also be used to play RPS and rhythm patterns. You can add dynamics to the sound by varying the force with which you strike the pads.

Using the Hold Function to Sustain a Sound

You can use the Hold function to make the sound continue even after you take your finger off the pad. This is useful when you want a sound such as a looped (repeating) phrase to play continuously.

To play other sounds while holding one sound

1. Hold down a pad and press [HOLD].

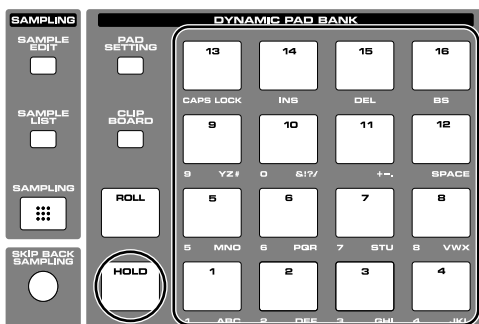

The [HOLD] and the pad will blink.

Hold will be turned on, and the sample will continue sounding even when you take your finger off the pad. In this state, pressing another pad will cause its sample to sound only as long as you continue pressing that pad.

2. When you once again press the blinking [PAD] or [HOLD], the sound will stop.

To hold two or more samples

1. Press [HOLD] so the pad is lit.
2. Press a pad.
The sample whose pad is blink will continue sounding. If you press another pad in this state, its sample will also continue sounding in the same way.
3. The sound will stop when you press a lit pad. When you press [HOLD], all samples will stop pad sounding.

NOTE

The Hold function will not work in the following cases:

- When RPS is on (p. 203)
- When the Tone Env Mode parameter (p. 87) is set to "NO-SUS"
- When the One Shot Mode parameter (p. 88) is on

Using the Roll Function to Play Sounds

You can use the Roll function to play a "roll" (repeated notes at brief intervals) as long as you continue holding the pad.

1. Hold down [ROLL] and press a pad.

- * If you press only [ROLL], a roll will continue sounding on all 16 pads.
- * If you press only [ROLL], the Roll function will be turned on for all sixteen pads.

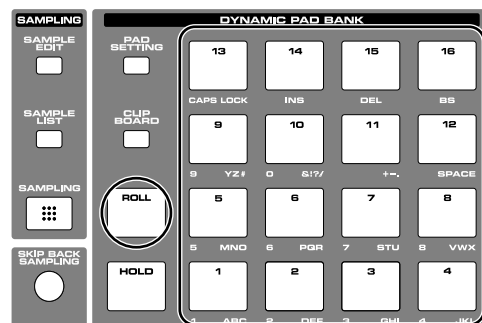

In this state, a roll will be played as long as you hold down a pad.

2. Take your hand off the pad, and the sound will stop.

- * The resolution of the roll is set by the Roll Resolution parameter (p. 162), which is displayed while you hold down [PAD SETTING].
- * You can vary the dynamics by varying the pressure on the pad.
- * If you selected "Multi Velo" in Pad Setting Quick Setup, that setting will be used (p. 161).

NOTE

The Roll function will not work in the following cases:

- When you have made settings so that a pattern is played when you press a pad
- When RPS is on (p. 203)

NOTE

This cannot be used to switch images via V-Link.

Making Settings for the Pads (Pad Setting)

Here you can make various settings for playing the pads; e.g., the note number that each pad will send to the sound generator section, the pad sensitivity, and the aftertouch sensitivity.

1. Press [PAD SETTING].

The Pad Setting screen will appear.

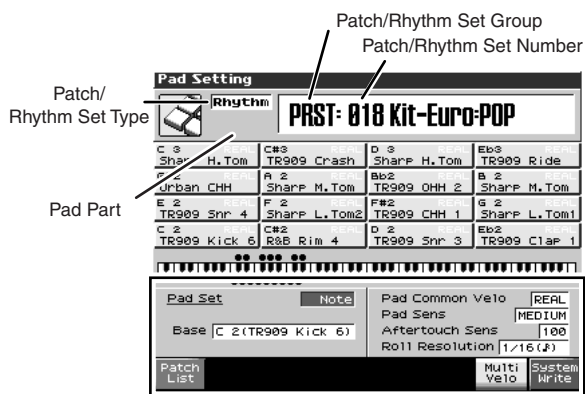

2. Press ▲ or ▼ to move the cursor to the desired parameter.

3. Turn the VALUE dial or use [INC] [DEC] to make pad settings.

Specify the Currently Used Sound Generator

You can specify the current sound generator mode (Patch or Performance) from this screen.

• Pad Part

Specifies the Part that will be played by the pad. This parameter is available only in Performance mode.

Value: 1–16

* If you make this setting, an indication of "PAD" will appear below the Part number in the Performance Layer and Mixer screens.

• Patch/Rhythm Set Type

Specifies whether Patch or Rhythm Set settings will be used for the pad part.

Value: Patch, Rhythm

• Patch/Rhythm Set Group

Specifies the patch or rhythm set group.

Value: USER, PR-A–H, GM, CARD, (XP-A–D)

• Patch/Rhythm Set Number

Selects the patch or rhythm set number.

Settings You Can Make for Each Pad

First, select the pad for which you want to make settings. When you strike a pad, its parameters will appear. Alternatively, you can move the cursor to "Pad Number" in the screen, and select the pad you want to edit.

• Note (Pad Note)

Specifies the note number transmitted by the selected pad.

• Velocity (Pad Velocity)

Specifies the strength of the sound when you strike the pad.

With the "COMMON" setting, the Pad Common Sens (the overall velocity sensitivity setting for all pads) will be used.

With a setting of "1–127," the sound generator will be played with that velocity value.

Value: COMMON, 1–127

Settings that Apply to All Pads

Quick Setup

This lets you make basic pad settings. For the greatest efficiency, use Quick Setup to choose the settings that are closest to what you have in mind. Then make the necessary changes for each pad.

1. In the Pad Setting screen, press [F7 (Quick Setup)].

The Quick Setup window will appear.

* This won't work if the Rhythm Pattern function is turned on. In order to make these settings, you'll need to press [RHYTHM] to turn off the Rhythm Pattern function.

2. Move the cursor and make settings.

• Template Set

Value

Note: The sixteen consecutive note numbers starting at the Base Note will be automatically assigned to the pads.

Rhythm: The note numbers will be arranged in the most suitable way for playing a rhythm set.

Multi Velo: "Multi Velocity" is a special setting that assigns the very same note number to each of the sixteen pads—but with differing velocities. This is convenient if you need precise control of the velocity while you play.

• Base Note (Pad Base Note)

Make this setting if you've selected Note or Multi Velo as the Template Set setting.

If you've selected Note, this specifies the location where the consecutive note numbers will begin (i.e., the lowest note).

If you've specified Multi Velo, this specifies the note number that all pads will play.

Value: C-1–G9

Using the Pads

Setting the Velocity for All Sixteen Pads at Once

Use this when you want to specify a common velocity for all sixteen pads. However if the pad velocity setting (of each pad) is set to other than Common, those settings will be used.

- **Pad Common Velo (Pad Common Velocity)**

For all sixteen pads, this specifies the velocity (loudness) that is produced when you strike a pad. With the “REAL” setting, you’ll be able to produce dynamics by varying your striking force. With a setting of “1–127,” the pads will produce the specified velocity value regardless of your actual striking force.

Value: REAL, 1–127

Adjusting the Pad Sensitivity

- **Pad Sens (Pad Sensitivity)**

Specifies the relation between your striking force and the velocity that is produced.

Value

LIGHT: It will be easy to produce the maximum velocity without having to strike very hard.

MEDIUM: This is the standard pad sensitivity setting.

HEAVY: You will have to strike quite strongly to produce the maximum velocity.

Adjusting the Aftertouch Sensitivity

- **Aftertouch Sens (Aftertouch Sensitivity)**

“Aftertouch” means additional pressure that you apply on a pad after striking it. This setting adjusts the aftertouch sensitivity. Higher values make it easier to apply aftertouch. Normally you will leave this at a setting of “100.”

Value: 0–100

Settings for the ROLL Button

- **Roll Resolution**

Specifies the rapidity of the repeated strikes when you use a pad to play a roll.

Value: ♩, ♩₃, ♩, ♩₃, ♩, ♩₃, ♩, ♩₃

Writing the Pad Settings

You can save one set of settings as System settings for Patch mode. Press [F8 (System Write)] to save the settings.

If you make settings in Performance mode, the pad settings will also be saved when you save the performance. This means that in Performance mode, you can have separate pad settings for each performance.

For details on how to save a performance, refer to “**Saving a Performance You’ve Created (Write)**” (p. 120).

Mode	Parameter	Write procedure
Performance mode	Pad Common Velo Pad Sens Aftertouch Sens Roll Resolution	Press [F8 (System Write)] * Save as System parameters
	Pad settings other than the above	Press [WRITE]. * Saved as performance parameters.
Patch mode	All pad settings	Press [F8 (System Write)]. * Saved as System parameter.

Exchanging the Sound of Two Pads (Pad Exchange)

Here’s how to exchange the sound of two selected pads.

* This setting exchanges the note numbers transmitted by the pads. This means that even if you execute this function, there’s no need to make a similar change for the sound generator settings.

1. Press [F6 (Pad Exchg)].

2. Select the number of a pad you want to exchange.

Use the VALUE dial or [INC][DEC], or strike a pad directly to make your selection.

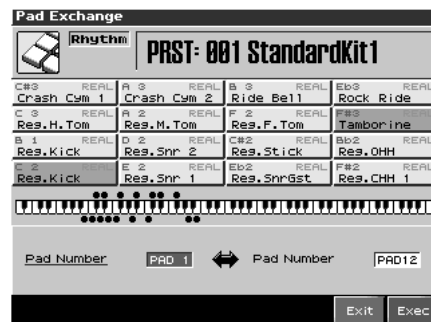

3. Press [F8 (EXEC)] to execute.

* If you decide to cancel, press [F7 (Cancel)].

Assigning a Pattern to a Pad (RPS Function)

The Fantom-X lets you assign a previously recorded phrase to a pad as a pattern, and play it by pressing that pad. For details, refer to (“**Playing a Phrase at the Touch of a Finger (RPS Function)**” (p. 203).

Using the Pads to Play Rhythms

The Fantom-X lets you assign rhythm patterns and/or rhythm sounds to the pads and play them by pressing the pads. For details, refer to “**Playing Rhythms**” (p. 135).

Playing Back a Song

This chapter explains how you can use the Fantom-X's sequencer to play back a song.

TIP

When you play back a song, we recommend that you use the sound generator in **Performance mode**. In Performance mode, up to sixteen different sounds can be played separately by the sixteen parts, making this mode ideal for playing songs that are multi-instrument ensembles of drums, bass, piano, etc.

Playing a Song Immediately (Quick Play)

The Fantom-X is able to play a song from user memory and memory card immediately, without first loading the song into Temporary Area. This is called the **Quick Play** function.

Quick Play can be used with MRC Pro songs (extension:.SVQ) and Standard MIDI Files (extension:.MID).

1. Press [SONG EDIT].

The Song Play screen appears.



2. Press [F1 (Song List)].

Turn the VALUE dial or press [INC] [DEC] to select the song that you want to play.



- **[F1 (User)]:** Songs in user memory
- **[F2 (Card)]:** Songs on a memory card

* By pressing ◀ or ▶ in the above screen, you can specify the type of songs that will be displayed. If various types of songs are saved together, it will be easier to find the desired song if you restrict the displayed file types in this way.

- **VIEW ALL:** all songs will be displayed
- **SVQ ONLY:** only SVQ files will be displayed
- **SMF:** only Standard MIDI Files will be displayed
- **MRC:** only MRC files will be displayed

3. Press [PLAY] to start playback.

When the song finishes playing, it will stop automatically. If you want to stop playback midway through the song, press [STOP].

MEMO

If you have interrupted song playback, "+" may be displayed at the right of the measure number. This indicates that the song is stopped in mid measure.

NOTE

There will be no sound if samples have not been loaded for the patches used in the song. You must load the necessary samples beforehand (p. 202).

Playing Back Songs Consecutively (Chain Play)

The **Chain Play** function lets you consecutively play back (Quick Play) songs on user memory and memory card.

1. Press [MENU] to access the Menu window.

2. Use ▲ or ▼ to select "Chain Play," and then select [ENTER].

The Chain Play screen appears.



3. Press [F1 (User)] if you want to choose from user memory, or press [F2 (Card)] if you want to choose from memory card.

NOTE

You cannot combine USER songs and CARD songs.

TIP

By holding down [SHIFT] and pressing ▲ or ▼ you can jump to the beginning or end of the song list.

If you want to perform Chain Play repeatedly, press [F7 (Repeat All)] to light it into red. If you press [F6 (Auto Step)] to light it into red, playback will end, and the next song will begin playing automatically.

4. Press [PLAY] to start Chain Play.

Starting from the song of step 1. If you want to stop playback before it is finished, press [STOP].

TIP

If you want to begin playback from midway through the chain, use ▲ or ▼ to move to the desired step, and then press [PLAY].

5. When you are finished with Chain Play, press [STOP].

NOTE

Chain Play cannot be started or stopped by a Start or Stop message from an external MIDI device. Nor will MIDI Continue, Song Position Pointer, Song Select, or Clock messages be received.

Various Playback Methods

Fast-Forward and Rewind During Playback

Fast-forward, rewind, and jump can be performed during playback, as well as while stopped. Use the following procedures for each operation.

- Fast-forward:** Press [FWD].
- Continuous fast-forward:** Press and hold [FWD].
- Rapid fast-forward:** Press [FWD] and then press [BWD].
- Rewind:** Press [BWD].
- Continuous rewind:** Press and hold [BWD].
- Rapid rewind:** Press [BWD] and then press [FWD].
- Jump to the previous locate position:**
Hold down [SHIFT] and press [BWD].
- Jump to the next locate position:**
Hold down [SHIFT] and press [FWD].
- Jump to the beginning of the song:**
Press [RESET].

NOTE

A certain amount of time may be required for fast-forward, rewind, or jump during Quick Play.

- Song playback will be interrupted if you jump to the beginning or end of the song while the song is playing.

Playing Back Correctly from the Middle of the Song (MIDI Update)

When you play back from the middle of a song, for example after fast-forward or rewind, the correct patch may not be selected, or the pitch may be incorrect. This is because the MIDI messages in the area that you skipped have not been transmitted to the sound generator. In such cases, you can use the **MIDI Update** function. When you perform **MIDI Update**, the MIDI messages (other than Note messages) from the beginning of the song until the location to which you moved will be transmitted to the sound generator, ensuring that the sound generator will be in the correct state for the resumption of playback.

1. Make sure that song playback is stopped.

NOTE

It is not possible to perform MIDI Update while the song is playing.

2. Hold down [SHIFT] and press [PLAY].

The display will indicate "MIDI Update..." while processing takes place, and when finished, will indicate "Completed!"

Muting the Playback of a Specific Instrument

If you want to silence the playback of a specific instrument, you can mute the phrase track that contains the sequencer data for that instrument.

cf.

For details on the procedure, refer to "**Silencing the Playback of a Track (Mute)**" (p. 178)

Playing Back a Song

Changing the Playback Tempo of a Song

The tempo at which a song will play back is recorded on its tempo track, but the tempo of the entire song can be adjusted during playback. The tempo at which the song actually plays is called the **playback tempo**.

NOTE

The playback tempo is a temporary setting. It will be lost if you switch to another song or turn off the power. If you want the song to always play back at this tempo, you must re-save the song to disk (p. 198).

1. Press [TEMPO].

The Tempo window appears.



2. Turn the VALUE dial or press [INC]/[DEC] to set the playback tempo.

- If you press [F7 (Click)] to light it into red, a click will sound at the specified tempo. This will switch on/off each time you press the button.
- By pressing [F6 (Tap)] you can set the tempo to the timing at which you press the button (Tap Tempo). Press the button three or more times at quarter-note intervals of the desired tempo.

3. When you have finished making settings, press [F8 (Close)].

Using a Controller to Change the Playback Tempo

Since tempo control is assigned to the realtime control knob of the Fantom-X, it's easy to change the playback tempo of the song.

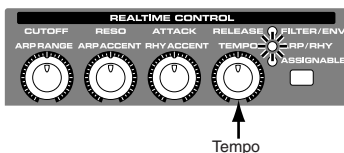

1. Press the **REALTIME CONTROL** button so the **ARP/RHY** indicator lights.
2. Play back the song, and turn the realtime control knob. You are also free to assign the Tempo Control function to the following controllers. For details on this setting, refer to the pages that discuss each controller.
 - D Beam controller (p. 122)

Playing a Song Back at a Fixed Tempo (Muting the Tempo Track)

If the tempo changes while a song is being played back, this is because those tempo changes have been recorded in the Tempo track. If you want to override these tempo changes and play back at a fixed tempo, you can mute the Tempo track.

cf.

For details on this operation, refer to “**Silencing the Playback of a Track (Mute)**” (p. 178).

Playing Back a S-MRC Format Song

The Fantom-X is able to play back S-MRC format songs created on the MC-50 in the same way as MRC Pro songs or Standard MIDI Files. However, S-MRC format songs cannot be Quick Played. You must first load them into Temporary Area and convert them to MRC Pro song format before playing them.

cf.

For details on the procedure, refer to “**Loading a Song (Load)**” (p. 201).

Playing Back a Song Repeatedly (Loop Play)

Use the Loop function when you want to repeatedly play back an entire song or just a specified portion of a song.

1. Press [SONG EDIT].

2. Press [F4 (Loop)].

The Loop window appears.

3. Press [F7 (Loop)] to light it into red.

The Loop switch will turn on. Now playback will loop according to the region and the number of times specified in the Loop window. To turn off the Loop switch, press [F7 (Loop)] once again.

cf.

For details on making settings in the Loop window, refer to “**Specifying the Area of a Song that will Repeat (Loop Points)**” (p. 179).

4. When you have finished making settings, press [F8 (Close)] to close the Loop window.

Using the D Beam Controller to Start/Stop Song Playback

You can start/stop song playback by passing your hand over the D Beam controller.

1. Select the song that you want to play back (p. 164).
2. Hold down [SHIFT] and press D BEAM [ASSIGNABLE].
The D Beam Assignable screen appears.



3. Use [CURSOR] to move the cursor to "Type."
4. Turn the VALUE dial or press [INC]/[DEC] to set this to "START/STOP."
5. Press D BEAM [ASSIGNABLE] to turn on the D Beam controller.
6. When you pass your hand across the D Beam controller, song playback will start. When you pass your hand across it once again, playback will stop.

TIP

You can also start/stop song playback by using a pedal connected to the PEDAL CONTROL jack (p. 226).

Recording Songs

This chapter explains the procedure for using the Fantom-X's sequencer to record a song.

TIP

Before you begin this procedure, put the sound generator in Performance mode. Normally, when recording or playing back a song, you will put the sound generator in **Performance mode**. The reason for this is that in this mode, only the sound of the specified MIDI channel will be heard when you record while playing the keyboard of the Fantom-X, and that when the song is played back, the parts can independently play up to 16 different sounds. Thus, Performance mode is suitable for recording and playing back a song that uses an ensemble of multiple instruments, such as drums, bass, and piano. In Performance mode, we recommend that you leave the keyboard switches (p. 101) turned off (unchecked). If any keyboard switches are on (checked), parts other than the current part will also sound when you play the keyboard; you probably don't want this to occur while you're creating a song.

Two Recording Methods

You can use one of two methods of recording: **realtime recording** or **step recording**. Select the method that is appropriate for your situation.

Realtime Recording (p. 170)

Realtime recording is the recording method in which your keyboard playing and controller operations are recorded just as you perform them.

Step Recording (p. 174)

Step recording is the recording method in which you can input notes and rests one by one. This method is suitable for inputting drums or bass with precise timing. In addition to using notes, you can also create a song by putting patterns together.

Before You Record a New Song

Overview of the Recording Process

The work flow for recording a new song is as follows.

1. Select the sound to be used for recording
2. Clear the Temporary Song
3. Specify the time signature of the song (p. 169)
4. Set the tempo (p. 169)
5. Use realtime recording (p. 170) or step recording (p. 174) to record
6. Use track edit (p. 180) or micro edit (p. 192) to edit the song
7. Save the song to user memory or memory card (p. 198)

With the factory settings, demo song data will automatically be loaded into Temporary Area when the Fantom-X is powered up. Here's how to change this setting so that this automatic load does not occur (i.e., the song memory will remain empty).

1. Press [MENU].
2. Press ▲ or ▼ to select "System," and then press [ENTER].
3. Press [F1 (↑)] or [F2 (↓)] to select "Startup."
4. Press [CURSOR] to select "Load Demo Song at Startup," and turn the VALUE dial, or press [INC]/[DEC] to set it to "OFF."

Select the Sound to be Used for Recording

Before you record a song, select the sound that you want to use for recording. Select the recording method that is appropriate for your situation.

Performance

Select a Performance when you want to record an ensemble performance using multiple instruments. When recording a song, we recommend that you normally select a Performance.

Patch/Rhythm set

Select a patch or rhythm set if you want to use a single patch or rhythm set to record your playing.

Erasing the Song/Pattern from Temporary Song (Song Clear)

When you record a song, the sequencer data is temporarily recorded in Temporary Area. If you want to record a new song, you must erase any existing sequencer data from Temporary Song.

NOTE

If Temporary Song contains an important song that you want to keep, you should first save that song to user memory/memory card (p. 198).

1. Press [SONG EDIT] to access the Song Play screen.

2. Press [F3 (Song Clear)].

The Song Clear window appears.

3. Press [F8 (Exec)] to execute the operation.

When the operation has been completed, the display will briefly indicate "Completed!"

To cancel, press [F7 (Cancel)].

Specify the Time Signature

Before you record a new song, you must specify the time signature. However, a time signature of 4/4 is automatically specified when you perform the Song Initialize operation or when the power is turned on, so you will need to make this setting only if you want to record a new song in a different time signature.

1. Press [SONG EDIT] to access the Song Play screen.
2. Press [F8 (Micro Edit)].
The Microscope screen appears.
3. Press [F7 (Trk/Ch)].
The Trc/Ch Select window appears.
4. Press ▲ or ▼ to move the cursor to “Track.”
5. Select “BEAT” (beat track).
The Microscope screen for the beat track appears.

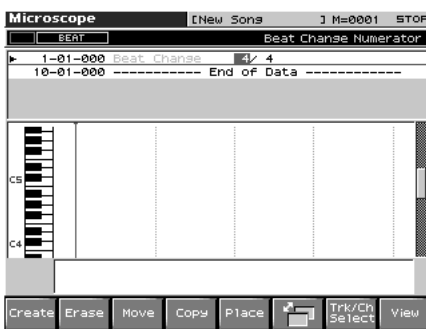

6. Move the cursor to “Beat Change,” and specify the time signature.

cf. ➔

If you want to change time signatures midway through the song, refer to “Changing the Time Signature Midway Through the Song” (p. 196).

7. Press [EXIT] to return to the previous screen.

cf. ➔

If you are recording to a phrase track, see “Recording Your Performance as You Play It (Realtime Recording)” (p. 170).

Specifying the Time Signature of a Pattern

Each pattern has a Pattern Beat setting that manages the time signature of that pattern. The pattern beat acts as a guide when the pattern is played or recorded, and is handled independently of the time signature of the song (i.e., the time signature recorded in the beat track).

The pattern beat is normally set to a time signature of 4/4, but you can change this setting when the song has a time signature other than 4/4, or when you want to record a pattern with a time signature different than that of the song.

Only one pattern beat setting can be specified at the beginning of each pattern. This means that it is not possible to change time signatures midway through a pattern.

1. Press [SONG EDIT] to access the Song Play screen.
2. Press [F2 (Ptn)] to light it into red.
The Pattern Play screen appears.
3. Turn the VALUE dial or press [INC][DEC] to select the pattern.
4. Press [F5 (Ptn Beat)].



5. Move the cursor, and set the time signature.

Setting the tempo

Set the tempo at which the song is to be recorded.

1. Press [TEMPO].
The Tempo window appears.



2. Turn the VALUE dial or press [INC][DEC] to set the playback tempo.
 - If you press [F7 (Click)] to light it into red, a click will sound at the specified tempo. This will switch on/off each time you press the button.
 - By pressing [F6 (Tap)] you can set the tempo to the timing at which you press the button (Tap Tempo). Press the button three or more times at quarter-note intervals of the desired tempo.
3. When you have finished making settings, press [F8 (Close)].

Recording Your Performance as You Play It (Realtime Recording)

Realtime Recording is the recording method in which your keyboard playing and controller operations are recorded just as you perform them. Use this recording method when you want to capture the nuances of your own performance.

Basic Operation for Realtime Recording

1. **Make sure that the preparations for recording have been completed as described in “Before You Record a New Song” (p. 168).**

TIP

If you want to record into an existing song, load the desired song into Temporary Song (p. 177). Then press [FWD] or [BWD] to specify the measure at which you want to begin recording. The measure at which recording will begin is indicated by the “M=” in the upper part of each PLAY screen.

2. **Press [REC].**

The [REC] indicator will blink, and the Realtime Rec Standby window appears.

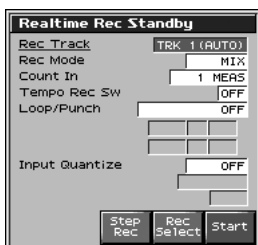

This window lets you set various parameters for realtime recording.

MEMO

If you want to record a pattern, press [F2 (Ptn)] in the Song Edit screen so it lights red, and then press [REC].

3. **As basic settings, specify the following three parameters. Use [CURSOR] to move the cursor to each parameter, and turn the VALUE dial or press [INC]/[DEC] to make the setting.**

- **Rec Track**

Specify the phrase track or pattern on which you want to record.

- * You can also make settings so that the phrase track of the same number as the current part will be selected automatically. This is convenient when you are recording just one part on each track. For details on how to make this setting, refer to p. 234.

Value: TRK 1–TRK 16,
PTN001–PTN100 (* when recording on a pattern)

- **Rec Mode (Recording Mode)**

Select how recording is to take place.

Value

MIX: Mix-recording will be carried out. Normally, you will record using this method. If a performance has already been recorded on the recording-destination track, your newly recorded performance will be added to the existing performance without erasing it. By using this in conjunction with Loop-recording, you can record repeatedly over a specified area without erasing the previously recorded performance. For example, this is a convenient way to record a drum performance one instrument at a time; bass drum -> snare drum -> hi-hat, etc.

REPLACE: Replace-recording will be carried out. If a performance has already been recorded on the recording-destination track, it will be erased as you record your new performance. Use this when you want to re-record.

- **Count In**

Select how recording is to begin.

Value

OFF: Recording will begin immediately when you press [PLAY].

1 MEAS: When you press [PLAY], a count (playback) will begin one measure before the recording-start location, and recording will begin when you reach the recording-start location.

2 MEAS: When you press [PLAY], a count (playback) will begin two measures before the recording-start location, and recording will begin when you reach the recording-start location.

WAIT NOTE: As an alternative to pressing [PLAY], you can play the keyboard, strike a pad, or press the Hold pedal to start recording.

4. **When you are finished making settings in the Realtime Rec Standby window, press [PLAY] or [F8 (Start)].**

The Realtime Rec Standby window will close, the [REC] indicator will change from blinking to lit, and recording will begin.

When recording begins, the Realtime Recording window will appear.



In this window you can perform the following operations.

- Specify the punch-in/out points (Punch In p. 171)
- Realtime Erase (Erase p. 173)
- Rehearsal function (Rehearsal p. 173)

For details on these operations, refer to the appropriate page.

To close the Realtime Recording window, press [F8 (Close)] or [PLAY]. To open it once again, press [PLAY].

5. **When you are finished recording, press [STOP].**

The [REC] indicator will go dark.

TIP

If you are not satisfied with the realtime recording you just made, you can press [MENU], and from the Menu window that appears, select “Undo/Redo” to return to the state prior to recording (Undo/Redo). After executing Undo, you can use Redo to revert to the previous state. After executing Undo, you can execute Redo by performing the above procedure the above procedure once again.

Recording Tempo Changes in a Song (Tempo Recording)

If you want the tempo to change during the song, you can record those tempo changes in the Tempo track. If tempo changes have already been recorded in the tempo track, they will be rewritten. Set the following recording parameters in addition to the basic settings described in step 3 of “Basic Operation for Realtime Recording” (p. 170).

Tempo Rec Sw (Tempo Recording Switch)

Specify whether tempo changes will be recorded (ON), or not (OFF).

Value: OFF, ON

TIP

You will be able to use realtime control knob ([]) movements to control the tempo easily (p. 140).

Loop Recording and Punch-In Recording

You can record repeatedly over a specified area (Loop recording), or re-record just that area (Punch-in recording).

Set the following recording parameters in addition to the basic settings described in step 3 of “Basic Operation for Realtime Recording” (p. 142).

Loop/Punch

Specify how loop recording or punch-in recording is to take place.

Value

OFF:	Loop recording or punch-in recording will not occur.
LOOP (POINT):	Recording takes place repeatedly, according to the loop point settings.
LOOP (1 MEAS):	The one-measure area starting at the record-start measure will be recorded repeatedly.
LOOP (2 MEAS):	The two-measure area starting at the record-start measure will be recorded repeatedly.
LOOP (4 MEAS):	The four-measure area starting at the record-start measure will be recorded repeatedly.
LOOP (8 MEAS):	The eight-measure area starting at the record-start measure will be recorded repeatedly.
LOOP (16 MEAS):	The sixteen-measure area starting at the record-start measure will be recorded repeatedly.
LOOP SONG ALL:	The entire song from beginning to end will be recorded repeatedly.
AUTO PUNCH:	Auto punch-in recording will be performed. You must pre-specify the area (punch points) in which recording is to take place. This is convenient when you want to re-record over a mistake. The song will play back when you begin recording. When you reach the punch-in point, playback will switch to record mode.
MANUAL PUNCH:	Manual punch-in recording will be performed. Recording takes place (erasing the existing data) in the area that you specify by pressing a pedal or button. This is convenient when you want to re-record more than one location in which you made a mistake. The song will play back when you begin recording. When you

press a pedal or button, playback will switch to record mode, and will switch back to play mode when you press the pedal or button once again. By pressing the pedal or button, you can toggle between record and play modes.

Start Point

Specify the measure and beat at which loop recording or auto punch-in recording is to begin. It is not possible to specify the Tick.

End Point

Specify the measure and beat at which loop recording or auto punch-in recording is to Stop. It is not possible to specify the Tick.

NOTE

The minimum loop length is four quarter notes.

Using Auto Punch-In Recording

1. In the Realtime Rec Standby window, set the Loop/Punch parameter to “AUTO PUNCH.”
2. Set the Start Point/End Point parameters to the desired punch points.
3. Move to a measure earlier than the specified Start Point, and press [PLAY].
The song will begin playing. Recording will begin at the location specified by the Start Point parameter. Playback will resume at the location specified by the End Point parameter.
4. Press [STOP] to stop playback.

Using Manual Punch-In Recording

TIP

If you want to use a pedal connected to the PEDAL CONTROL jack to specify the area for recording, you must first set the Pedal 1 or 2 Assign parameter to “PUNCH I/O” (p. 226).

1. In the Realtime Rec Standby window, set the Loop/Punch parameter to “MANUAL PUNCH.”
 2. Press [PLAY].
Song playback will begin, and the Realtime Recording window will appear.
- 
3. At the point where you want to begin recording, press [F5 (Punch In)] or step on the pedal.
Playback will switch to record mode.
 4. At the point where you want to stop recording, once again press [F5 (PUNCH OUT)] or step on the pedal.
You will return to playback mode.
 5. Press [STOP] to stop playback.

Correct the Timing of Your Playing as You Record (Recording Quantize)

The **Quantize** function automatically corrects inaccuracies in the timing of your keyboard or pad performance, aligning the notes to accurate timing intervals. During realtime recording, you can quantize while you record.

Set the following recording parameters in addition to the basic settings described in step 3 of “**Basic Operation for Realtime Recording**” (p. 170).

Input Quantize

Specify whether to quantize while recording.

Value

OFF: Quantize will not be applied while recording.

GRID: Grid Quantize will be applied while recording. Use this when you want the timing to be accurate, such as when recording drums or bass.

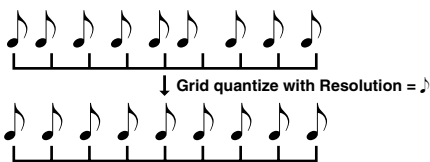

SHUFFLE: Shuffle Quantize will be applied while recording. Use this when you want to give the rhythm a “shuffle” or “swing” character.

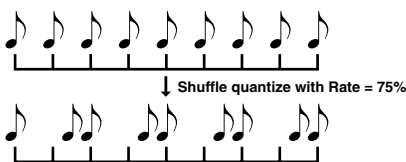

Grid Resolution

Make this setting when you are using Grid Quantize. Specify the quantization interval in terms of a note value. Select the shortest note value that will occur in the range to which Grid Quantize will be applied.

Value: ♩, ♩₃, ♩, ♩₃, ♩, ♩₃, ♩

Strength (Grid Quantize Strength)

Make this setting when you are using Grid Quantize. It specifies the degree to which notes will be adjusted toward the timing intervals specified by the Grid Resolution parameter. With a setting of “100%,” the notes will be corrected precisely to the timing of the Grid Resolution parameter. As you lower this setting, the note timing will be corrected to a lesser extent, and with a setting of “0%” the timing will not be adjusted at all.

Value: 0–100

Shuffle Resolution

When you are using Shuffle Quantize, make this setting to specify the note value used for quantization.

Value: ♩, ♩

Rate (Shuffle Quantize Rate)

Make this setting when using Shuffle Quantize. It specifies the degree to which the backbeat will be separated from the downbeat specified by the Shuffle Resolution parameter. With a setting of “50%,” the backbeat will be exactly between adjacent downbeats. With a setting of “0%,” the backbeat will be moved to the same timing as the preceding downbeat. With a setting of “100%,” the backbeat will be moved to the same timing as the following downbeat.

Value: 0–100

Selecting the Sequencer Data that will Be Recorded (Recording Select)

When you use realtime recording, all of your sequencer data will normally be recorded. If you want to avoid recording a specific type of data, you can turn its Recording Select setting “OFF.”

1. Press [REC].
2. Press [F7 (Rec Select)].
The Recording Select window appears.



3. Use ▲ or ▼ to select the sequencer data (MIDI messages) that will be recorded.

- Note:** Note messages. These MIDI messages represent notes.
- Poly Aftertouch:** Polyphonic aftertouch. These MIDI messages apply aftertouch to individual keys.
- Control Change:** Control change messages. These MIDI messages apply various effects such as modulation or expression.
- Program Change:** Program change messages. These MIDI messages select sounds.
- Channel Aftertouch:** Channel aftertouch messages. These MIDI messages apply aftertouch to an entire MIDI channel.
- Pitch Bend:** Pitch bend messages. These MIDI messages change the pitch.
- System Exclusive:** System exclusive messages. These MIDI messages are used to make settings unique to the Fantom-X, such as sound parameters.

- Turn the VALUE dial or press [INC]/[DEC] to add a check mark.

The message will be recorded if you assign a check mark (✓), and will not be recorded if you remove the check mark.

If you press [F6 (All Off)], no sequencer data will be recorded.

If you press [F7 (All On)], all of the sequencer data will be recorded.

- Press [F8 (Close)] to close the Recording Select window.

Erasing Unwanted Data While You Record (Realtime Erase)

Realtime Erase is a function that erases unwanted data during realtime recording. This is particularly convenient during loop recording, since it lets you erase data without stopping recording.

NOTE

Realtime Erase can be executed only if the Recording Mode is set to "MIX."

NOTE

You can also erase the data of a specific channel.

- Begin realtime recording (p. 170).

The Realtime Recording window appears.



- Press [F6 (Erase)].

The Realtime Erase window appears.

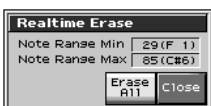

- Erase unwanted data.

To erase all data (except for Pattern Call messages), press [F7 (Erase All)]. Data will be erased for as long as you hold down the button.

To erase notes of a specific key, hold down that key. Data for that note will be erased for as long as you hold down that key.

To erase notes of a specific key range, hold down the top and bottom keys of that range. Data for that range will be erased for as long as you hold down those keys.

- Press [F8 (Close)] to close the Realtime Erase window.

You will return to the normal recording state.

* You can also erase the data of a specific channel.

Recording Arpeggios Aligned to the Measures of the Sequencer

When recording arpeggios in real time, you can synchronize the arpeggio with the sequencer start/stop timing.

For details, refer to "Arpeggio/Rhythm Sync Switch" (p. 227).

Auditioning Sounds or Phrases While Recording (Rehearsal Function)

The Rehearsal function lets you temporarily suspend recording during realtime recording. This is convenient when you want to audition the sound that you will use next, or to practice the phrase that you will record next.

- Begin realtime recording (p. 170).

The Realtime Recording window appears.



- Press [F7 (Rehearsal)] or [REC].

The [REC] indicator will blink, indicating that you are in rehearsal mode. In this state, nothing will be recorded when you play the keyboard.

- To return to record mode, press [F7 (Rehearsal)] or [REC] once again.

- **Step Back**

Cancel the previously input note.

- **Tie**

Extend the length of the previously input note by the current setting.

- **Rest**

Inputs a rest. First set the Note Type parameter to a length that is the same as the rest you want to input, and then press [F3 (Rest)].

- **Zoom In**

Narrow the range of keys shown in the display. Use this when you want to view certain notes at greater magnification.

- **Zoom Out**

Expand the range of notes shown in the display. Use this when you want to see which notes have been input.

8. Repeat the above steps to continue inputting.

TIP

The previous value of each parameter is remembered. This means that if you want to use the same settings as the previously input note, there is no need to change the settings. Once you have set the Gate Time parameter and Input Velocity parameter, it is not normally necessary to change them, so all you have to do is set the Step Time parameter and specify the pitch (note) of each note.

TIP

The note will not be finalized as long as you hold down the key. This means that you will be able to modify the various parameters of the note (Step Time, Gate Ratio, Velocity).

9. When you are finished step recording, press [STOP].

The [REC] indicator will go dark.

TIP

If you are not happy with the results of the previous step recording, you can press [MENU], and from the Menu window that appears, select "Undo/Redo" to return to the state prior to recording (Undo/Redo). After executing Undo, you can use Redo to revert to the previous state. After executing Undo, you can execute Redo by performing the above procedure the above procedure once again.

Inputting a Chord

Press the chord. The cursor will move to the next step when you release all keys or pads.

Moving the input location



















- Pressing [F8 (⇒)] will move the input location forward by the current Note Type value.
- Pressing [F7 (⇐)] will move the input location backward by the current Note Type value.
- Hold down [SHIFT] and press [F8 (⇒)] will advance the input location by one measure.
- Hold down [SHIFT] and press [F7 (⇐)] will return the input location by one measure.

Moving the display region

Pressing ▲ or ▼ will move the displayed region of notes upward or downward.

The Relation between Note Value Length and Gate Time

The relation between the length of the note value and the gate time is shown below. Since the Fantom-X's sequencer uses a TPQN (Ticks Per Quarter Note; i.e., resolution) of 480, a quarter note gate time is 480 ticks.

Note	Gate time
	30
	40
	45
	60
	80
	90
	120
	160
	180
	240
	320
	360
	480
	640
	720
	960
	1920
	3840

TIP

The gate time that is recorded in step recording will be the original gate time value multiplied by the value of the Gate Ratio parameter. For example, if the Gate Ratio parameter is set to "80%," inputting a quarter note will mean that the gate time is $480 \times 0.8=384$.

Assigning a Pattern to a Phrase Track

You can create a song by combining previously recorded patterns. This is done using step recording to assign patterns to a phrase track. However, please be aware that the patterns themselves are not placed in the phrase track. Rather, **Pattern Call messages** are placed in the phrase track to specify which pattern should be played back. This means that if you later modify the contents of a pattern, the song playback will also be affected.

NOTE

When you assign a pattern to a phrase track, its pattern beat will be ignored, and the pattern will use the time signature of the beat track. If the pattern beat and the beat track have different settings, the length of the measures will not match, and the playback may become incorrectly aligned. If this occurs, re-specify the time signature of the beat track (p. 169).

1. Make sure that the preparations for recording have been performed as described in “Before You Record a New Song” (p. 168).

2. Press [REC], and then [F6 (Step Rec)].

The [REC] indicator will blink, and the Step Rec Standby window appears.

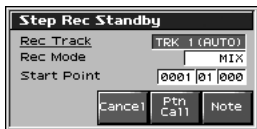

3. Make settings for step recording. Use [CURSOR] to move the cursor to the desired parameter, and turn the VALUE dial or press [INC]/[DEC] to set it.

- **Rec Track**

Specify the phrase track or pattern on which you want to record. “TRK” will appear if you press [F1 (Song List)], and “PTN” will appear if you press [F2 (PTN)].

Value: AUTO, TRK 1–TRK 16

- **Rec Mode (Recording Mode)**

Select how recording is to take place.

Value

MIX: Mix-recording will be carried out. Normally, you will record using this method. If a performance has already been recorded on the recording-destination track, your newly recorded performance will be added to the existing performance without erasing it.

REPLACE: Replace-recording will be carried out. If a performance has already been recorded on the recording-destination track, it will be erased as you record your new performance. Use this when you want to re-record.

- **Start Point**

Specify the location (measure-beat-tick) at which recording will begin.

4. Press [F7 (Ptn Call)].

5. Turn the VALUE dial or press [INC]/[DEC] to select the pattern number (1–100) that you want to assign to the phrase track.

The pattern name of the selected pattern is displayed in “Pattern.” “Length” shows the number of measures in the pattern.

6. Press [F8 (Put Ptn)].

A Pattern Call message for the pattern selected by the Pattern parameter will be recorded. You will advance by the length of the measures in that pattern, and will be ready to input the next pattern.



If you input the wrong pattern, you can press [BWD] or [F1 (Step Back)] to delete the previously input Pattern Call message.

7. Repeat the above steps to assign additional patterns.

8. When you are finished with step recording, press [EXIT] or [STOP].

The [REC] indicator will go dark.



If you are not satisfied with the step recording that you just performed, press [MENU], and from the Menu window that appears, select “Undo/Redo” to return to the state prior to recording (Undo/Redo). After executing Undo, you can use Redo to revert to the previous state. After executing Undo, you can execute Redo by performing the above procedure the above procedure once again.

Editing Songs

This chapter explains the procedure for editing songs.

Loading the Song You Want to Edit

When you edit a song, you're modifying a song that's already recorded into Temporary Song. When you're going to edit a song saved to user memory or memory card, you have to first load it into the Temporary Area.

NOTE

The Temporary Song will be lost if you turn power off or load another song into Temporary Area. If Temporary Area contains a song you wish to keep, you must save that song to user memory or memory card (p. 198).

1. Press [SONG EDIT].

The Song Edit screen appears.



2. Press [F1 (Song List)].

The Song List screen appears.



* By pressing ◀ or ▶ in the above screen, you can specify the type of songs that will be displayed. If various types of songs are saved together, it will be easier to find the desired song if you restrict the displayed file types in this way.

- **VIEW ALL:** all songs will be displayed
- **SVQ ONLY:** only SVQ files will be displayed
- **SMF:** only Standard MIDI Files will be displayed
- **MRC:** only MRC files will be displayed

3. Press [F1 (User)] or [F2 (Card)] to select the loading destination.

4. Use ▲ or ▼ to select the song that you want to edit.

5. Press [F8 (Load)].

A Message will ask you for confirmation.

6. Press [F8 (Exec)].

When the song has finished loading, the performance data of the loaded song will be displayed in the Song Edit screen.

* You can also load a song by pressing [SAVE/LOAD] (p. 201).

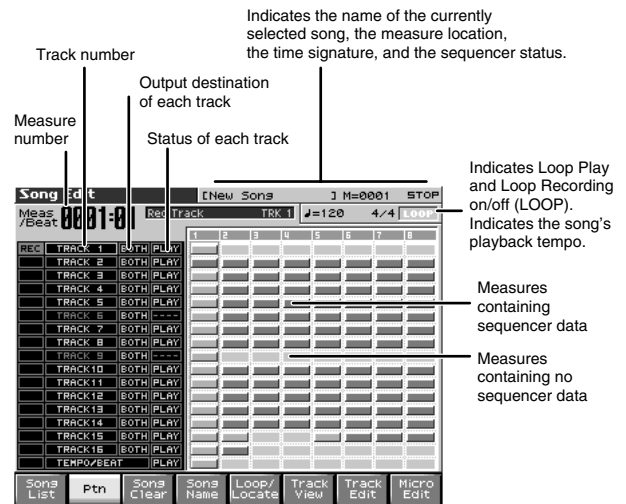

MEMO

If you play back the song while the Song Edit screen is displayed, the screen will scroll in keeping with the song playback location.

Editing Songs

Viewing the data within a track

The Fantom-X can record data for multiple MIDI channels in a single track. From the Song Edit screen, press [F6 (Track View)] to see which channel(s) of data are found in each track.

This screen graphically shows the note data of each channel. The height of the bar indicates the note pitch, and the length of the bar indicates the duration.

Press [F6] once again to return to the previous screen.

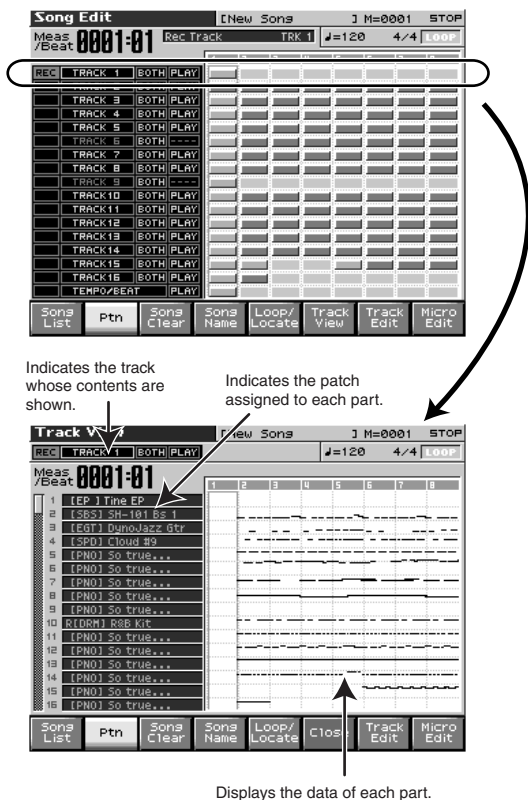

Using Different Sound Generators for Each Track

By specifying the output destination for each track, you can use a variety of sound generators when playing back a song.

1. Press [SONG EDIT] to access the Song Edit screen.
2. Use [CURSOR] to move the cursor for the track whose output destination you want to specify.



3. By turning the VALUE dial or by pressing [INC]/[DEC], set the value.

- OFF:** The track will not be sounded.
- INT:** The track will be sounded by the Fantom-X's internal sound generator.
- MIDI:** The track will be sounded by an external sound generator connected to the MIDI OUT connector.
- BOTH:** The track will be sounded by both the internal and external sound generators.

Loading Individual Tracks/Patterns of Song Data

If you have selected a song file (extension ".SVQ") or Standard MIDI File (extension ".MID"), you can load individual phrase tracks or patterns.

1. After step 4 of "Loading the Song You Want to Edit," press [F7 (Load Track)].

The Load Track window appears.

2. Move the cursor to the left of "Source" (load source), and select the track (TRK 1–16) or pattern (PTN001–100) that you want to load.

* If you are loading from a Standard MIDI File, it is not possible to select patterns (PTN001–100). Also, if you are loading from a Format 0 Standard MIDI File, this will be fixed at "TRK ALL," and individual tracks cannot be selected.

3. Move the cursor to the right of "Destination" (load destination), and select the load-destination track (TRK 1–16) or pattern (PTN001–100).

4. Press [F8 (Exec)] to execute the operation.

Silencing the Playback of a Track (Mute)

If you wish to silence specific track during playback, you can mute the appropriate Phrase track containing that sequencer data.

1. Press [SONG EDIT] to access the Song Edit screen.
2. Use [CURSOR] to move the cursor for the track that you want to silence.



MEMO

Tracks in which no sequencer data has been recorded are displayed as "—."

- Turn the VALUE dial or press [DEC] to select "MUTE."

NOTE

Note that if you save a song with a Phrase track muted in the Standard MIDI File format, that Phrase track's data will not be saved. If you save a song that has a muted Phrase track in the MRC Pro song format, the mute status of the track will also be saved.

TIP

If you set the tempo track (Tempo) "Status" to "MUTE," the tempo track will be muted. If tempo changes have been recorded in a song, but you want to play the song at a fixed tempo, you can mute the tempo track.

Assigning Markers (Locate Positions) to a Song

Markers can be assigned to any location in a song. These are called **Locate Positions**. Normally, locations in a song are indicated as "measure-beat-tick," but a locate position is also displayed as an absolute time of "hours:minutes:seconds:frames."

NOTE

It is not possible to assign a locate position to a pattern.

Assigning a Locate Position

Up to four locate positions can be assigned in each song.

- Press [SONG EDIT].
- Press [F5 (Loop / Locate)].
The Loop window appears.
- Press [F2 (Locate)].
The Locate window appears.

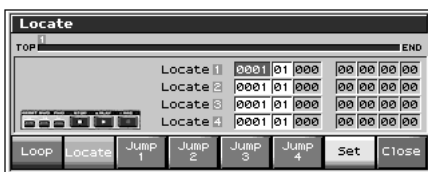

- Press [F7 (Set)]; then press [F3 (Set1) – [F6 (Set4)] to assign the current location of the song as a locate position.

You can assign a locate position in this way even while listening to the song play back.

* You can also adjust the locate position by moving the cursor to the "measure" or "beat" value of the locate number and turning the VALUE dial or pressing [INC]/[DEC] to set each value.

Moving to a Locate Position

Use the following procedure to change the song location to a Locate Position.

- Access the Locate window.
- If [F7 (Set)] is lit red, press it to turn off the illumination.
- Press [F3 (Jump1)] – [F6 (Jump4)].

You will move to the specified locate position.

TIP

You can hold down [SHIFT] and press [BWD] to jump to the preceding location position, or hold down [SHIFT] and press [FWD] to jump to the next locate position.

Specifying the Area of a Song that will Repeat (Loop Points)

When using Loop Play or Loop Recording, you can use the loop points you specify here to specify the repeated area, as an alternative to repeating the specified number of measures.

NOTE

It is not possible to assign a loop point to a pattern.

- Press [SONG EDIT].
- Press [F5 (Loop / Locate)].
The Loop window appears.



- Move the cursor to the desired parameter, and turn the VALUE dial or press [INC]/[DEC] to make the setting.

- Repeat**

Select the number of repeats (1–99). If you want repetition to continue until you press [STOP], set this to "INF."

- Start Point**

Specify the location at which repetition is to begin.

If you press [F5 (Set Start)], the current location of the song will be set as the starting location.

- End Point**

Specify the location at which repetition will end. The location you specify here will not be included in the repeated area.

If you press [F6 (Set End)], the current location of the song will be set as the ending location.

- If you press [F7 (Loop)] to light it into red, looping will be turned on.

Editing Sequencer Data Over the Specified Range (Track Edit)

Track Edit lets you edit areas of sequencer data that you specify.

Basic Operation for Track Editing

1. Access the Song Edit screen, and then load the song you want to edit (p. 177).

MEMO

While editing a pattern, press [SONG EDIT] and then press [F2 (PTN)] to access the Pattern Edit screen.

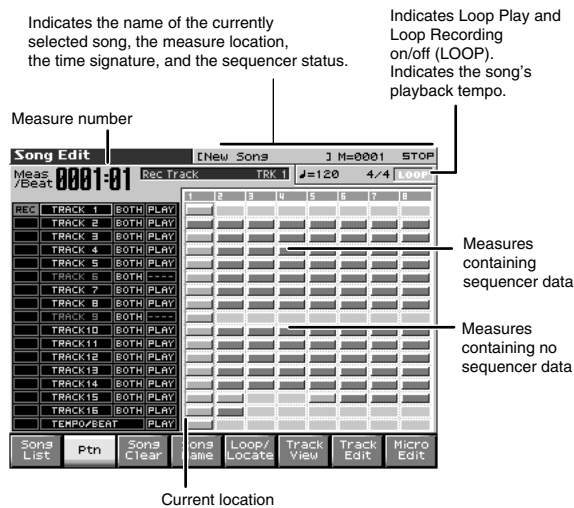

cf.

If the Song Edit screen shows "QUICK PLAY," the song has not been loaded. If you want to edit this song, press [F8 (Load)] to load the song.

- * Press [F7 (Temp Song)] to return to the temporary song display.

2. Press [SONG EDIT] and then press [F8 (Track Edit)].

The Track Edit window appears.



3. Use the cursor buttons to select the desired function.

- * You can also select a function by pressing a pad.

- Quantize->p. 181
- Erase->p. 183
- Delete->p. 184
- Copy->p. 184
- Insert Measure->p. 185
- Transpose->p. 185
- Change Velocity->p. 186
- Change Channel->p. 186
- Change Duration->p. 187
- Merge->p. 188
- Extract->p. 188
- Shift Clock->p. 189
- Data Thin->p. 190
- Exchange->p. 191
- Time Fit->p. 191
- Truncate->p. 191

cf.

For details on the setting windows of each track editing function, refer to the following explanations of each function.

4. Set the parameters for each function. Use [CURSOR] to move the cursor to the desired parameter, and turn the VALUE dial or press [INC]/[DEC] to set the value. First check the region that is to be affected by the editing operation, and then make corrections if you want to change it.
5. Press [F8 (Exec)] to execute the operation.

When the operation is completed, the display will briefly indicate "Completed!"

TIP

If you decide not to execute the operation, press [F7 (Cancel)].

- If you are not satisfied with the results of executing the function, you can press [MENU], and from the Menu window that appears, select "Undo Track Edit" to return to the state prior to executing the operation (Undo/Redo). After executing Undo, you can use Redo to revert to the previous state. After executing Undo, you can execute Redo by performing the above procedure the above procedure once again.

Aligning a Song's Timing (Quantize)

In the chapter “Recording Songs” (p. 168), we explained **Recording Quantize**, which lets you quantize during realtime recording. Alternatively, it is also possible to quantize a song that has already been recorded.

The Fantom-X has a **Preview function** that allows playing back the results of a Quantize operation while you are still setting parameters (before actual execution). This helps to make optimal Quantize settings.

NOTE

The Quantize operation will correct only the timing at which notes were pressed (note-on) and released (note-off), and will not correct any other sequencer data. This means that if you record MIDI messages such as bend range or modulation along with notes, quantization can cause the notes to go out of sync with the MIDI messages, skewing timing. To avoid such problems it is better to record non-keyboard data afterward, using mix recording, etc.

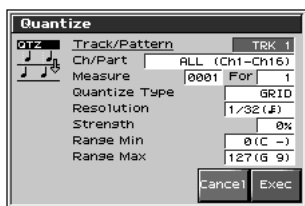

cf.

For details on the settings, refer to “Basic Operation for Track Editing” (p. 180)

Track / Pattern

Sets the phrase track(s) or pattern that is to be quantized.

Value

TRK ALL: Phrase tracks 1–16

TRK 1–TRK 16: The specified phrase track

PTN001–PTN100: The specified pattern

Ch / Part

Specifies the MIDI channel(s) of the notes to be quantized.

If you wish to quantize all notes, set this parameter to “ALL.” When quantizing only the notes of a specific MIDI channel, select that channel.

Value: ALL, Ch1–Ch16

Measure, For (Edit Range)

Sets the range of measures that are to be quantized. If you set “For” to “ALL,” all measures will be specified.

Quantize Type

Specifies the Quantize range.

Value

GRID: Grid Quantize will be applied to recording. Since the notes will be adjusted to the timing of the specified note value, you can use this when you want drums or bass (for example) to play in an accurate rhythm.

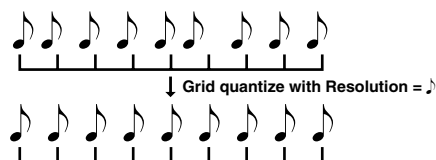

SHUFFLE: Shuffle Quantize will be applied to recording. Use this when you want to produce a “shuffle” or “swing” rhythmic feel.

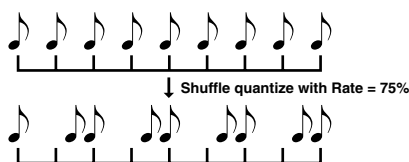

TEMPLATE: The Fantom-X provides 71 quantize templates. These templates contain various quantize settings for applying rhythmic ‘feels’ of many different musical categories. Select the template you want for quantization.

* If your sequencer data notes are too far off from accurate time, Template Quantize may not work that efficiently so you won't achieve the desired results. If this is the case, apply Grid Quantize to your sequencer data first to lose timing mistakes.

Resolution (Grid Quantize Resolution)

This parameter is used when Grid Quantize is selected. Specifies quantization time interval as a note value. Choose a Resolution that matches the smallest note in the area you're quantizing.

Value: ♩, ♩₃, ♩, ♩₃, ♩, ♩₃, ♩

Strength (Grid Quantize Strength)

This parameter is used when Grid Quantize is selected. This parameter specifies a percentage of how note timing will be corrected toward the timing interval that is specified by the Resolution parameter. With a setting of “100%,” the note will move all the way to the nearest timing interval of the Grid Resolution setting. A setting of “0%” will not change note timing at all.

Resolution (Shuffle Quantize Resolution)

This parameter is used when Shuffle Quantize is selected. Specifies quantization time interval as a note value.

Value: ♩, ♩

Rate (Shuffle Quantize Rate)

This parameter is used when Shuffle Quantize is selected. Specifies how far apart you want a down-beat specified by the Shuffle Resolution parameter to be from the up-beat that immediately follows. By shifting the timing of an up-beat, you can create a "swing" feel. A setting of "50%" will place the timing of the up-beat note at the exact mid point between the down-beat and the next down-beat. A setting of "0%" will move the up-beat note to the same timing as the previous down-beat. A setting of "100%" will move it to the same timing as the following down-beat.

Value: 0–100%

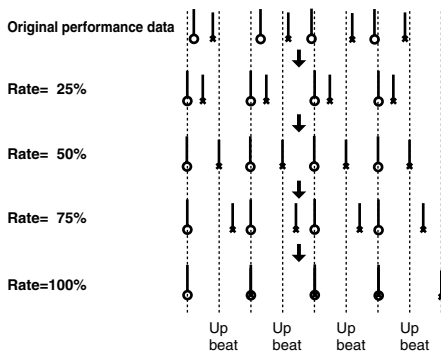

Quantize Template (Quantize Template)

Specifies the template you wish to use.

Here is a list of preset groove templates.

001	Dance (small dynamics)
002	Dance (large dynamics)
003	Dance (light swing)
004	Dance (heavy swing)
005	Dance (dragging beats, small dynamics)
006	Dance (dragging beats, large dynamics)
007	Dance (dragging beats, light swing)
008	Dance (dragging beats, heavy swing)
009	Dance (pushing beats, small dynamics)
010	Dance (pushing beats, large dynamics)
011	Dance (pushing beats, light swing)
012	Dance (pushing beats, heavy swing)
013	Fusion (small dynamics)
014	Fusion (large dynamics)
015	Fusion (light swing)
016	Fusion (heavy swing)
017	Fusion (dragging beats, small dynamics)
018	Fusion (dragging beats, large dynamics)
019	Fusion (dragging beats, light swing)
020	Fusion (dragging beats, heavy swing)
021	Fusion (pushing beats, small dynamics)
022	Fusion (pushing beats, large dynamics)
023	Fusion (pushing beats, light swing)
024	Fusion (pushing beats, heavy swing)
025	Reggae (small dynamics)
026	Reggae (large dynamics)
027	Reggae (light swing)
028	Reggae (heavy swing)
029	Reggae (dragging beats, small dynamics)
030	Reggae (dragging beats, large dynamics)

031	Reggae (dragging beats, light swing)
032	Reggae (dragging beats, heavy swing)
033	Reggae (pushing beats, small dynamics)
034	Reggae (pushing beats, large dynamics)
035	Reggae (pushing beats, light swing)
036	Reggae (pushing beats, heavy swing)
037	Pops (small dynamics)
038	Pops (large dynamics)
039	Pops (light swing)
040	Pops (heavy swing)
041	Pops (dragging beats, small dynamics)
042	Pops (dragging beats, large dynamics)
043	Pops (dragging beats, light swing)
044	Pops (dragging beats, heavy swing)
045	Pops (pushing beats, small dynamics)
046	Pops (pushing beats, large dynamics)
047	Pops (pushing beats, light swing)
048	Pops (pushing beats, heavy swing)
049	Rhumba (small dynamics)
050	Rhumba (large dynamics)
051	Rhumba (light swing)
052	Rhumba (heavy swing)
053	Rhumba (dragging beats, small dynamics)
054	Rhumba (dragging beats, large dynamics)
055	Rhumba (dragging beats, light swing)
056	Rhumba (dragging beats, heavy swing)
057	Rhumba (pushing beats, small dynamics)
058	Rhumba (pushing beats, large dynamics)
059	Rhumba (pushing beats, light swing)
060	Rhumba (pushing beats, heavy swing)
061	Samba (for Pandeiro, etc.)
062	Samba (for Surdo, Timbale)
063	Axe (for Caixa)
064	Axe (for Surdo)
065	Salsa (for Cascala)
066	Salsa (for Conga)
067	Triplets
068	Quintuplets
069	Sextuplets
070	Septuplets over two beats
071	Lagging triplets

* The templates are designed for a 4/4 time signature. Applying them to a performance of a different time signature may not produce the desired result.

* The style names shown here are only for your convenience; they are not intended to imply that the templates are usable only for the named style. You can certainly try them with other styles of music.

Timing (Quantize Timing)

This specifies how much a note will move toward the timing interval of the template you pick. At a setting of 100%, the note will be perfectly timed with the template. At a setting of 0%, the note will not move at all.

Range Min, Range Max

Specifies the range of note numbers to be quantized. For example, if you want to quantize the range between C3 and C4, set "Note Min" to "C3," and set "Note Max" to "C4." You can also specify the key range by pressing keys on the keyboard.

Preview Function

The Preview function allows you to hear how quantizing will work while you are still setting Quantize parameters (before you execute operation). This is called the **Preview function**. If you modify parameter values during preview playback, the next preview playback will include those latest value changes. Try various parameter settings to find the one that works best.

NOTE

Pattern Call events assigned to a phrase track or muted phrase tracks cannot be previewed.

Pressing [PLAY] when the Track Edit (Quantize) window is displayed selects Preview mode. The two measures from the current location of the song will play back repeatedly. The preview start location can also be specified by pressing [FWD] or [BWD]. To exit Preview mode, press [STOP].

Erasing Unwanted Performance Data (Erase)

This function erases all the sequencer data inside the specified area. As the erased data is replaced by rests, the original measures will remain.

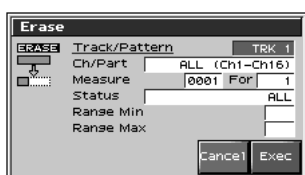

cf.

For details on the settings, refer to "Basic Operation for Track Editing" (p. 180)

Track / Pattern

Specifies the track(s) or pattern that is to be erased.

Value

- ALL:** Phrase tracks 1-16, the beat track, and the tempo track
- TRK 1-TRK 16:** The specified phrase track
- TEMPO:** Tempo track
- PTN001-PTN100:** The specified pattern

Ch / Part

Selects the MIDI channel of the data to be erased.

When you want to erase all sequencer data, set this parameter to "ALL." To erase sequencer data of one specific MIDI channel only, select that MIDI channel.

Value: ALL, Ch1-Ch16

If you set the Track parameter to "TEMPO," or if the Status parameter is set to "System Exclusive," "Tune Request" or "Pattern Call," the Channel parameter will not be available.

Measure, For (Edit Range)

Specifies the range of measures that are to be erased. If you set "For" to "ALL," all measures will be specified.

Status

Selects the type of data to be erased.

Value

- ALL
- NOTE
- Poly Aftertouch
- Control Change
- Program Change
- Channel Aftertouch
- Pitch Bend
- System Exclusive
- Tune Request
- Pattern Call

NOTE

If the Track parameter is set to "TEMPO," the Status parameter will not be available.

Range Min, Range Max

If you have set the Status parameter to "NOTE," "P.AFT," "C.C.," or "PROG.," specify the range. Set "Range Min" to the lowest value of the range, and "Range Max" to the highest value of the range.

TIP

To erase all notes or polyphonic aftertouch data, set "Range Min" to "C -1" and "Range Max" to "G9." To erase C4, set "Range Min" and "Range Max" to "C4." To erase C3 through C4, set "Range Min" to "C 3" and "Range Max" to "C4."

- To erase all controller numbers, set "Range Min" to "0" and "Range Max" to "127." To erase all program numbers, set "Range Min" to "1" and "Range Max" to "128." To erase number 4, set "Range Min" and "Range Max" to "4." To erase numbers 3 through 14, set "Range Min" to "3" and "Range Max" to "14."

Deleting Unwanted Measures (Delete)

This function deletes a specified area of sequencer data, and moves the subsequent data to fill the gap. As a result, the measure length will be shortened by the number of deleted measures.

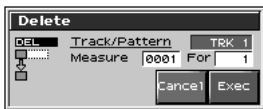

cf.

For details on the settings, refer to “Basic Operation for Track Editing” (p. 180)

Track / Pattern

Specifies the track(s) or pattern that is to be deleted.

Value

- ALL:** Phrase tracks 1–16, the beat track, and the tempo track
- TRK 1–TRK 16:** The specified phrase track
- TEMPO:** Tempo track
- PTN001–PTN100:** The specified pattern

Measure, For (Edit Range)

Specifies the range of measures that are to be deleted. If you set “For” to “ALL,” all measures will be specified.

Copying Phrases (Copy)

This function copies a specified area of sequencer data. It is convenient for repeating the same phrase several times. You can copy patterns to a phrase track, or copy data from a phrase track to a pattern.

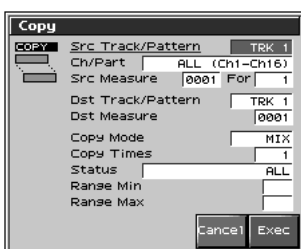

cf.

For details on the settings, refer to “Basic Operation for Track Editing” (p. 180)

Src Track / Pattern (Source Track / Pattern)

Specifies the copy-source track(s) or pattern.

Value

- ALL:** Phrase tracks 1–16, the beat track, and the tempo track
- TRK 1–TRK 16:** The specified phrase track
- TEMPO:** Tempo track
- PTN001–PTN100:** The specified pattern

Ch / Part

Selects the MIDI channel of the data to be copied.

When you want to copy all the sequencer data, set this parameter to “ALL.” To copy only the sequencer data of a specific MIDI channel, select the MIDI channel.

Value: ALL, Ch1–Ch16

NOTE

If you set the source track to “TEMPO,” or if the Status parameter is set to “System Exclusive,” “Tune Request” or “Pattern Call,” the Channel parameter will not be available.

Src Measure, For (Edit Range)

Specifies the range of copy-source measures. If you set “For” to “ALL,” all measures will be specified.

Dst Track/ Pattern (Destination Track/Pattern)

Check/modify the copy-destination track or pattern.

Value

- ALL:** Phrase tracks 1–16, the beat track, and the tempo track
- TRK 1–TRK 16:** The specified phrase track
- TEMPO:** Tempo track
- PTN001–PTN100:** The specified pattern

MEMO

If you set the source track to “ALL,” the destination track can be set to either “ALL” or “PTN001–PTN100.” If you select “PTN001–PTN100,” the data from the 16 phrase tracks will be merged as it is copied.

- If “TEMPO” is selected as the source track, then only “Tempo” can be selected for the destination track.

Dst Measure (Destination Measure)

Specifies the copy-destination measure.

If you want the copy destination to be right after the last measure of a song, set this parameter to “END.”

Copy Mode

Specifies whether you want to preserve the existing data in the copy destination when copying.

Value

- MIX:** Combines the data from the copy source with the existing data in the copy destination.
- REPLACE:** Musical data in the copy destination will be erased (i.e., overwritten) when the copy takes place. Only the sequencer data of the MIDI channels specified by the Channel parameter will be overwritten, and data of other MIDI channels will remain.

Copy Times

Specifies the number of times that the data will be copied to the copy destination.

Status

Selects the type of data to be copied.

Value

- ALL
- NOTE
- Poly Aftertouch
- Control Change
- Program Change
- Channel Aftertouch
- Pitch Bend
- System Exclusive
- Tune Request
- Pattern Call

NOTE

If the source track is set to "TEMPO," the Status parameter will not be available.

Range Min, Range Max

If you have selected "NOTE," "P.AFT," "C.C.," or "PROG" for the Status parameter, specify the range. Set "Range Min" to the lowest value of the range, and "Range Max" to the highest value of the range.

TIP

To copy all notes or polyphonic aftertouch data, set "Range Min" to "C-1" and "Range Max" to "G9." To copy C4, set "Range Min" and "Range Max" to "C4." To copy C3 through C4, set "Range Min" to "C3" and "Range Max" to "C4."

- To copy all controller numbers, set "Range Min" to "0" and "Range Max" to "127." To copy all program numbers, set "Range Min" to "1" and "Range Max" to "128." To copy number 4, set "Range Min" and "Range Max" to "4." To copy numbers 3 through 14, set "Range Min" to "3" and "Range Max" to "14."

Inserting a Blank Measure (Insert)

This function inserts blank measures into a specified song position. As you can set the time signature of the blank measures, this is convenient when inserting a phrase having a different time signature in the middle of a song.

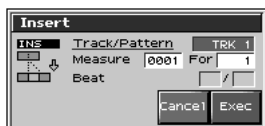

cf.

For details on the settings, refer to "Basic Operation for Track Editing" (p. 180)

Track / Pattern (Source Track)

Specifies the track(s) or pattern into which blank measures will be inserted.

Value

- ALL:** Phrase tracks 1–16, the beat track, and the tempo track
- TRK 1–TRK 16:** The specified phrase track
- TEMPO:** Tempo track
- PTN001–PTN100:** The specified pattern

Measure, For (Edit Range)

Specifies the measure location at which the blank measures are to be inserted, and the number of blank measures to be inserted.

Beat

In general, the time signature of the measure immediately before insertion will be used for the blank measures. To change the time signature of the blank measures to be inserted, use the Beat parameter.

NOTE

Beat can be specified only when you have set the Track parameter to "ALL."

Transpose the Key (Transpose)

This transposes the pitch of notes within a specified area, over a +/- 127 semitone range. Use this function to modulate from one key to another in a song, or to transpose the entire song.

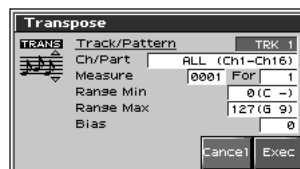

cf.

For details on the settings, refer to "Basic Operation for Track Editing" (p. 180)

Track / Pattern (Source Track)

Sets the phrase track(s) or pattern that is to be transposed.

Value

- ALL:** Phrase Tracks 1–16
- TRK 1–TRK 16:** The specified phrase track
- PTN001–PTN100:** The specified pattern

Ch / Part

Specifies the MIDI channel(s) of the notes to be transposed. Set this parameter to "ALL" for transposing all notes. When transposing only the notes of specific MIDI channel(s), select the MIDI channel(s) using this parameter.

Value: ALL, Ch1–Ch16

Measure, For (Edit Range)

Sets the range of measures that are to be transposed. If you set "For" to "ALL," all measures will be specified.

Editing Songs

Range Min, Range Max

Specifies the range of note numbers to be transposed. For example, if you want to transpose notes in the range of C3 through C4, set "Range Min" to "C3" and "Range Max" to "C4." You can also specify the key range by pressing keys on the keyboard.

Bias

Specifies the transpose amount in semitone steps. Set a "+" (positive) value to raise the pitch, or a "-" (negative) value to lower the pitch. If you do not want to transpose, set this to "0."

Value: -127- +127

If You Want to Lower the Bass Sound One Octave...

If your bass is played one octave higher than the staff notation, use the Transpose function to lower it one octave.

To lower the bass sound one octave, set the Range parameter to "Lowest-Highest" for the bass part, and set the Bias parameter to "-12."

When You Want to Change Percussion Sounds...

You can also use the Transpose function to change percussion sounds.

Suppose you want to change conga to tom. If the conga sound is assigned to the D4 key, and the tom sound is assigned to the C3 key, set the Range parameter to "D4-D4" and the Bias parameter to "-14."

Changing the Velocity (Volume) (Change Velocity)

This function modifies the keyboard playing dynamics (velocity) of a specified note area.

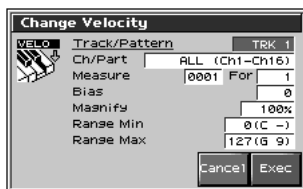

cf.

For details on the settings, refer to "Basic Operation for Track Editing" (p. 180)

Track / Pattern (Source Track)

Specifies the phrase track(s) or pattern whose velocity will be changed.

Value

ALL: Phrase Tracks 1-16
TRK 1-TRK 16: The specified phrase track
PTN001-PTN100: The specified pattern

Ch / Part

Specifies the MIDI channel(s) of notes for which velocity will be modified.

To modify velocity for all notes, set this parameter to "ALL." When modifying the velocity for only the notes of a specific MIDI channel, select that MIDI channel using this parameter.

Value: ALL, Ch1-Ch16

Measure, For (Edit Range)

Specifies the range of measures whose velocity will be changed. If you set "For" to "ALL," all measures will be specified.

Bias

Use this parameter to add a fixed bias amount to all velocities. If you want to increase the velocity values by 10, set this to "+10."

Value: -99- +99

Magnify

Set this parameter if increases or decreases in velocity variations are desired. For less velocity variation, use settings of "99%" or less. For more velocity variation, set it to "101%" or greater. With a setting of "100%," velocity values do not change.

Value: 0-200%

Range Min, Range Max

Specifies the range of note numbers for which velocity will be modified. For example, if you want to modify the velocity of notes in the range of C3 through C4, set "Range Min" to "C3" and "Range Max" to "C4." You can also specify the key range by pressing keys on the keyboard.

Changing the MIDI Channel (Change Channel)

This function transfers the MIDI channel of a specified area of sequencer data into a different MIDI channel.

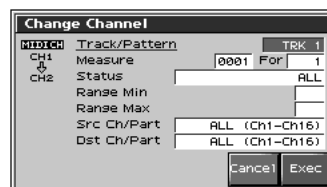

cf.

For details on the settings, refer to "Basic Operation for Track Editing" (p. 180)

Track / Pattern (Source Track)

Specifies the phrase track(s) or pattern in which the MIDI channel will be changed.

Value

ALL: Phrase Tracks 1-16
TRK 1-TRK 16: The specified phrase track
PTN001-PTN100: The specified pattern

Measure, For (Edit Range)

Specifies the range of measures in which the MIDI channel will be changed. If you set "For" to "ALL," all measures will be specified.

Status

Selects the type of data for which you wish to change the MIDI channel.

Value

- ALL
- NOTE
- Polyphonic Aftertouch
- Control Change
- Program Change
- Channel Aftertouch
- Pitch Bend

Range Min, Range Max

If you have set the Status parameter to "NOTE," "P.AFT," "C.C.," or "PROG," you can specify the range of data. Set "Range Min" to the lowest value of the range, and "Range Max" to the highest value of the range.

TIP

To change the MIDI channel of all notes or polyphonic aftertouch data, set "Range Min" to "C -1" and "Range Max" to "G9." To change the MIDI channel of C4, set "Range Min" and "Range Max" to "C4." To change C3 through C4, set "Range Min" to "C3" and "Range Max" to "C4."

- To change the MIDI channel of all controller numbers, set "Range Min" to "0" and "Range Max" to "127." To change the MIDI channel of all program numbers, set "Range Min" to "1" and "Range Max" to "128." To change number 4, set "Range Min" and "Range Max" to "4." To change numbers 3 through 14, set "Range Min" to "3" and "Range Max" to "14."

Src Channel, Dst Channel (MIDI Channel)

Set Src Channel to the MIDI channel that you want to change, and set Dst Channel to the MIDI channel to which it will be changed. If you have selected ALL for the source MIDI channel, the sequencer data of all MIDI channels will be combined into the destination MIDI channel.

Value: ALL, 1–16

NOTE

It is not possible to select "ALL" for the destination MIDI channel.

Modifying the Length of Notes (Change Duration)

This function modifies the duration (time from note-on to note-off) of notes within a specified area. Depending on the setting, you can also create staccato or tenuto.

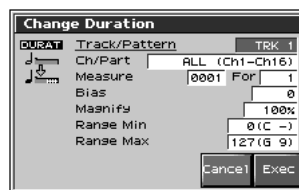

cf.

For details on the settings, refer to "Basic Operation for Track Editing" (p. 180)

Track / Pattern (Source Track)

Specifies the phrase track(s) or pattern whose durations will be changed.

Value

ALL: Phrase Tracks 1–16

TRK 1–TRK 16: The specified phrase track

PTN001–PTN100: The specified pattern

Ch / Part

Specifies the MIDI channel(s) of notes for which duration will be modified.

If you wish to modify the duration for notes of all MIDI channels, set this parameter to ALL. When changing the duration for notes of a specific MIDI channel only, select that MIDI channel using this parameter.

Value: ALL, Ch1–Ch16

Measure, For (Edit Range)

Specifies the range of measures whose durations will be changed. If you set "For" to "ALL," all measures will be specified.

Bias

Set this parameter if you wish to increase or decrease all durations by a fixed amount. If you want to extend all duration by 10, set this to "+10."

Value: -4800– +4800

Magnify

Set this parameter if you wish to increase or decrease durations by a specified ratio. When set to "100%," no change is made. A value of "101%" or higher increases the duration; values of "99%" or lower decrease the duration. For example, to halve duration, set this parameter to "50%." To double durations, set this parameter to "200%."

Value: 0–200%

Range Min, Range Max

Specifies the range of note numbers for which duration will be modified. For example, if you want to change the duration of notes in the range of C3 to C4, set "Range Min" to "C3" and "Range Min" to "C4." You can also specify the key range by pressing keys on the keyboard.

Combining Two Phrase Tracks or Patterns into One (Merge)

The sequencer data of two phrase tracks or patterns will be combined into one.

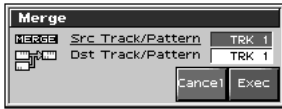

cf.

For details on the settings, refer to “Basic Operation for Track Editing” (p. 180)

Src Track / Src Pattern (Source Track)

Specifies the phrase track or pattern that is to be merged. After the Merge operation has been executed, no sequencer data will remain in this track.

Value

TRK 1–TRK 16: The specified phrase track

PTN001–PTN100: The specified pattern

Dst Track / Pattern (Destination Track/Pattern)

Specifies the merge-destination phrase track or pattern. After the Merge operation has been executed, the sequencer data will be combined into this track.

Value

TRK 1–TRK 16: The specified phrase track

PTN001–PTN100: The specified pattern

Extracting and Moving a Part of Sequencer Data (Extract)

This function extracts a specified sequencer data area from a phrase track or pattern and moves it to the same Song position of another phrase track or pattern. Additionally, just as with Standard MIDI File Format 0, when sequencer data from multiple MIDI channels is recorded on one track, you can also assign one MIDI channel to a single phrase track.

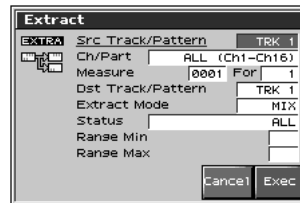

cf.

For details on the settings, refer to “Basic Operation for Track Editing” (p. 180)

Src Track / Src Pattern (Source Track)

Specifies the phrase track or pattern from which the sequencer data will be extracted. After Extract is executed, the selected sequencer data no longer remains on this phrase track or pattern.

Value

TRK 1–TRK 16: The specified phrase track

PTN001–PTN100: The specified pattern

Ch / Part

Selects the MIDI channel(s) of the data to be extracted.

To extract all sequencer data, set this parameter to ALL. To extract just the sequencer data of a specific MIDI channel, select that MIDI channel.

Value: ALL, Ch1–Ch16

NOTE

If you set the Status parameter to “System Exclusive,” “Tune Request” or “Pattern Call,” the Channel parameter will not be available.

Measure, For (Edit Range)

Specifies the range of measures from which sequencer data will be extracted. If you set “for” to “ALL,” all measures will be specified.

Dst Track / Pattern (Destination Track/Pattern)

Specifies the move-destination track or pattern.

Value

ALL: According to its MIDI channel, the sequencer data will be divided among phrase tracks 1–16.

TRK 1–TRK 16: The specified phrase track

PTN001–PTN100: The specified pattern

Extract Mode

Specifies whether you want to keep the sequencer data at the destination.

Value

MIX: The data at the destination will combine with the extracted data.

REPLACE: The data at the destination will be erased and replaced by the extracted data.

MEMO

If you select "REPLACE," only the sequencer data on the MIDI channel specified by the Channel parameter will be the object of the operation. Sequencer data of all other MIDI channels will be unaffected.

Status

Selects the type of data to be extracted.

Value

ALL

NOTE

Poly Aftertouch

Control Change

Program Change

Channel Aftertouch

Pitch Bend

System Exclusive

Tune Request

Pattern Call

Range Min, Range Max

If you set the Status parameter to "NOTE," "P.AFT," "C.C," or "PROG," specify the range of data. Set "Range Min" to the lowest value of the range, and "Range Max" to the highest value of the range.

TIP

To extract all notes or polyphonic aftertouch data, set "Range Min" to "C -1," and "Range Max" to "G9." To extract C4, set "Range Min" and "Range Max" to "C4." To extract C3 through C4, set "Range Min" to "C3" and "Range Max" to "C4."

- To extract all controller numbers, set "Range Min" to "0" and "Range Max" to "127." To extract all program numbers, set "Range Min" to "1" and "Range Max" to "128." To extract number 4, set "Range Min" and "Range Max" to "4." To extract numbers 3 through 14, set "Range Min" to "3" and "Range Max" to "14."

Shifting Performance Data Forward and Back (Shift Clock)

This function shifts the timing of sequencer data backward or forward in time within a specified area in steps of 1 tick. Slight shifts of timing can speed up or drag performance.

NOTE

When this function is executed, data that would be moved to a point before the beginning of the song will automatically shift to the beginning of the song. If data would be moved to a point past the end of the song, additional new measures will be created automatically as needed. The time signature of the newly created measures will be the same as that of the measure immediately preceding.

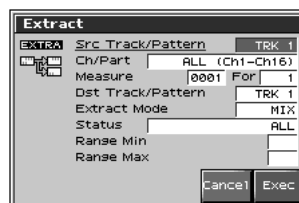

cf.

For details on the settings, refer to "Basic Operation for Track Editing" (p. 180)

Track / Pattern (Source Track)

Specifies the track(s) or pattern whose sequencer data will be moved in units of one tick.

Value

ALL: Phrase tracks 1–16, the beat track, and the tempo track

TRK 1–TRK 16: The specified phrase track

TEMPO: Tempo track

PTN001–PTN100: The specified pattern

Ch / Part

Selects the MIDI channel of the data to be shifted in time.

To shift ticks of all sequencer data, set this parameter to ALL. To shift the sequencer data tick of just one specific MIDI channel, select that MIDI channel.

Value: ALL, Ch1–Ch16

NOTE

If you set the Track parameter to "TEMPO," or if the Status parameter is set to "System Exclusive," "Tune Request" or "Pattern Call," the Channel parameter will not be available.

Measure, For (Edit Range)

Specifies the range of measures in which the sequencer data will be moved in units of one tick. If you set "For" to "ALL," all measures will be specified.

Bias

Specify the amount (number of ticks) by which the sequencer data will be moved.

Value: -4800– +4800

Status

Selects the type of data to be shifted in time.

Value

ALL

NOTE

Polyphonic Aftertouch

Control Change

Program Change

Channel Aftertouch

Pitch Bend

System Exclusive

Tune Request

Pattern Call

NOTE

If the Track parameter is set to "TEMPO," the Status parameter will not be available.

Range Min, Range Max

If you set the Status parameter to "NOTE," "P.AFT," "C.C.," or "PROG," specify the range of data. Set "Range Min" to the lowest value of the range, and "Range Max" to the highest value of the range.

TIP

To shift all notes or polyphonic aftertouch data, set "Range Min" to "C -1" and "Range Max" to "G9." To shift C4, set "Range Min" and "Range Max" to "C4." To shift C3 through C4, set "Range Min" to "C3" and "Range Max" to "C4."

- To shift all controller numbers, set "Range Min" to "0" and "Range Max" to "127." To shift all program numbers, set "Range Min" to "1" and "Range Max" to "128." To shift number 4, set "Range Min" and "Range Max" to "4." To shift numbers 3 through 14, set "Range Min" to "3" and "Range Max" to "14."

Thinning Out the Sequencer Data (Data Thin)

Continuously variable controllers such as aftertouch, pitch bend, and expression tend to create unexpectedly large amounts of data when operated. Data Thin will strip out redundant data to increase the amount of memory available for the sequencer.

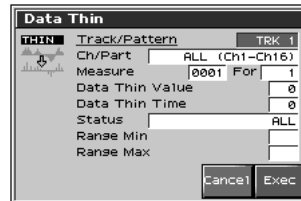

cf.

For details on the settings, refer to "Basic Operation for Track Editing" (p. 180)

Track / Pattern (Source Track)

Specifies the track(s) or pattern whose sequencer data will be thinned.

Value

ALL: Phrase tracks 1–16, the beat track, and the tempo track

TRK 1–TRK 16: The specified phrase track

PTN001–PTN100: The specified pattern

Ch / Part

Selects MIDI channel of the data to be thinned.

To thin all sequencer data, set this parameter to ALL. To thin sequencer data of just one specific MIDI channel, select that MIDI channel.

Value: ALL, Ch1–Ch16

Measure, For (Edit Range)

Specifies the range of measures whose sequencer data will be thinned. If you set "For" to "ALL," all measures will be specified.

Data Thin Value

For thinning data which incorporates rapid changes, use higher settings. If you don't want to thin that much data even though it is subject to rapid change, use lower settings.

Data Thin Time

If you are thinning data that changes gradually over time, use higher settings. If you don't want to thin that much data even though the changes are gradual, use lower settings.

Status

Selects the type of data to be thinned.

Value

- ALL
- Polyphonic Aftertouch
- Control Change
- Channel Aftertouch
- Pitch Bend

Range Min, Range Max

If you set the Status parameter to "P.AFT" or "C.C.," specify the range of data. Set "Range Min" to the lowest value of the range, and "Range Max" to the highest value of the range.

TIP

To thin out all polyphonic aftertouch data, set "Range Min" to "C-1" and "Range Max" to "G9." To thin out C4, set "Range Min" and "Range Max" to "C4." To thin out C3 through C4, set "Range Min" to "C3" and "Range Max" to "C4."

- To thin out all controller numbers, set "Range Min" to "0" and "Range Max" to "127." To thin out number 4, set "Range Min" and "Range Max" to "4." To thin out numbers 3 through 14, set "Range Min" to "3" and "Range Max" to "14."

Swapping Two Phrase Tracks or Patterns (Exchange)

The phrase tracks or patterns will be exchanged in their entirety.

Value

TRK 1–TRK 16: The specified phrase track

PTN001–PTN100: The specified pattern

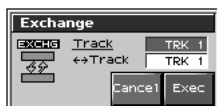

cf.

For details on the settings, refer to "Basic Operation for Track Editing" (p. 180)

Adjusting the Song's Playback Time (Time Fit)

This function calculates the playback time of a song or allows you to modify the tempo track data so that the song will play back in a specified time.



cf.

For details on the settings, refer to "Basic Operation for Track Editing" (p. 180)

Measure, For (Edit Range)

Measure the playback time, or check/modify the range of measures that are to be adjusted. If you set "For" to "ALL," all measures will be specified.

Time H/M/S

The playback time will be displayed. From left to right, the time display indicates "hours: minutes: seconds."

Time Original H/M/S

The current playback time will be displayed.

Deleting Blank Measures (Truncate)

Copying or merging may sometimes create blank measures at the beginning of a phrase track or pattern. Truncate deletes silent portions from the beginning of the specified phrase track to the first note-on.

NOTE

If other sequencer data (such as program changes or control changes) is recorded between the beginning and the first note-on of the specified phrase track, only the last data event of each type will be placed before the note-on.

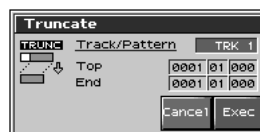

cf.

For details on the settings, refer to "Basic Operation for Track Editing" (p. 180)

Track / Pattern (Source Track)

Specifies the phrase track or pattern from which blank measures will be deleted.

Value

TRK 1–TRK 16: The specified phrase track

PTN001–PTN100: The specified pattern

Below the Track parameter is displayed the location of the beginning of the specified track, and the position of the first note-on.

Editing Individual Items of Sequencer Data (Micro Edit)

Micro Edit lets you edit individual items of sequencer data recorded in a song, such as MIDI messages and tempo data.

Editing Sequencer Data (Basic Procedure in the Microscope)

Access the Microscope screen when you want to view the sequencer data recorded in a song. Each line indicates the location (measure-beat-tick) at which the sequencer data is recorded, and the data recorded at that location.

1. Load the song that contains the sequencer data you want to view/edit (p. 177).

2. Press [F8 (Micro Edit)].

The Microscope screen appears.

Press ▲ or ▼ to view sequencer data.

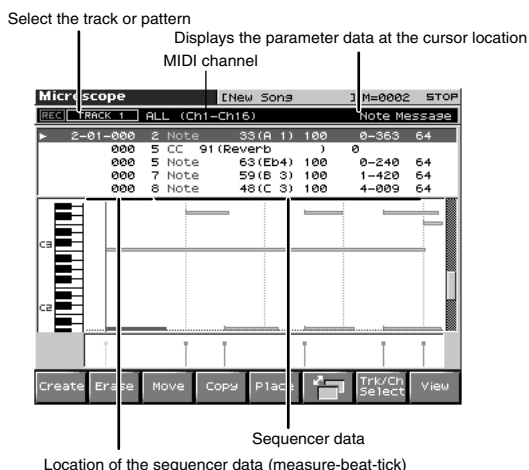

3. Press [F6] to switch the screen.

Each time you press [F6] you will switch between the two screens.

4. Press [F7 (Trk/Ch Select)] to move the cursor to "Track," and select the track or pattern whose sequencer data you want to view/edit.

TRK 1–TRK 16: The specified phrase track

TEMPO: Tempo track

BEAT: Beat track

PTN001–PTN100: The specified pattern (pattern mode only)

MEMO

In order to make efficient use of screen space, display is normally omitted for locations in which no sequencer data is recorded.

cf.

For an explanation of each type of sequencer data, refer to "Sequencer Data Handled by a Phrase Track/Pattern," below.

5. Move to the cursor to "Ch/Part," and select the MIDI channel of the sequencer data that you want to view.
6. Press [F8 (Close)] to close the screen.
7. Press ▲ or ▼ to select the performance data that you want to edit.
8. Press ◀ or ▶ to select the parameter that you want to edit.
9. Turn the VALUE dial or press [INC]/[DEC] to set the value.

TIP

When editing the Note Number of note or polyphonic aftertouch data, or the On Velocity or Off Velocity of a note, you can also specify the value by playing a key on the keyboard.

- When you press [ENTER], the sequencer data currently shown at the "■" will be transmitted from the MIDI OUT connector. In the case of a note message, the note will sound when you press [ENTER].

cf.

If you want to edit a system exclusive message, refer to "Editing a System Exclusive Message," below.

10. Repeat steps 3–6 to set each parameter you want to edit.

11. To close the Microscope screen, press [EXIT].

Editing a System Exclusive Message

1. Use ▲ or ▼ to move the cursor to the location of the system exclusive message that you want to edit.

2. Press ▶.

The System Exclusive Edit window appears.

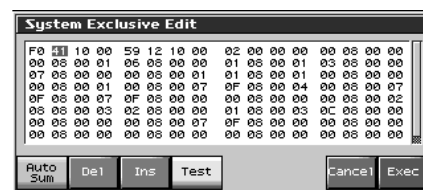

3. Press ◀ or ▶ to move the cursor to the data that you want to edit.

4. Turn the VALUE dial or press [INC]/[DEC] to edit the value.

If you want to add data between "F0:" and ":F7," move the cursor to that location and press [F3 (Insert)]. A value of "00" will be inserted. Change this to the desired value.

To delete data, move the cursor to the relevant location and press [F2 (Delete)].

5. When you are finished editing, press [F8 (Exec)] to finalize the values of the system exclusive message.

To cancel, press [F7 (Cancel)].

TIP

If you decide to discard the changes you made to the system exclusive message and return to the Microscope screen, press [EXIT].

- In the case of a Roland type IV system exclusive message, the checksum can be calculated automatically when you finalize the values. If you do not want to calculate the checksum automatically, press [F1 (Auto Sum)] to turn off the light.
- When you press [F4 (Test)], the system exclusive message you are editing will be transmitted from the MIDI OUT connector.

Sequencer Data Handled by a Phrase Track/Pattern

Phrase tracks or patterns can record the following nine types of sequencer data. The recorded location (measure-beat-tick) is displayed at the far left of each data item, and the MIDI channel number is displayed beside it.

Note

These MIDI messages represent notes. From the left, the parameters are Note Number, which indicates the name of the note; On Velocity, which specifies the force with which the key is pressed; Duration, which specifies the duration of the note; and Off Velocity, which determines the speed with which the key is released.

Program Change

This MIDI message switches sounds. The program number (PC#) selects the sound.

Control Change

This MIDI message applies various effects such as modulation or expression. The controller number (CC#) selects the function, and Value specifies the depth of the effect.

cf.

For the function corresponding to each controller number, refer to “MIDI Implementation” (p. 298).

Pitch Bend

This MIDI message changes the pitch. The value specifies the amount of pitch change.

Polyphonic Aftertouch

This MIDI messages applies aftertouch to an individual note. From the left, the parameters are Note Number which specifies the key, and Value which specifies the depth of the aftertouch.

Channel Aftertouch

This MIDI message applies aftertouch to an entire MIDI channel. Value specifies the depth of the aftertouch.

System Exclusive messages

These are MIDI messages used to make settings unique to the Fantom-X, such as sound settings. Input the data between “F0” and “F7.”

cf.

For details on system exclusive messages, refer to “MIDI Implementation” (p. 298).

Tune Request

This MIDI message causes an analog synthesizer to tune itself.

Ptn (Pattern Call message)

This is data that causes a pattern to play back. Use the Number parameter to select the pattern number. The pattern name is shown in parentheses (), and the location at which the pattern will finish playing is shown at the right of the “->” symbol.

NOTE

If the pattern called by the Pattern Call message extends beyond the last measure of the song, the pattern playback will be interrupted at that point.

- Only one pattern can be played at a time by Pattern Call messages in a given phrase track. This means that if a Pattern Call message is recorded at a location before the previous pattern has finished playing, the pattern that was playing will be interrupted, and the next pattern will begin playing. If more than one Pattern Call message is recorded at the same location, the message that is displayed last in the Microscope screen will be played.
- Although it is possible to record Pattern Call messages in a pattern, they will not be played. If you want to place the data of another pattern into a pattern, use Track Edit to copy the data.

Data Handled by the Tempo Track

The Tempo track records tempo data for the song.

Tempo Change

This data specifies the tempo. The song will play back according to the “Value” of the tempo change.

The value displayed in “♩ =**” is the tempo at which the song will actually play (the playback tempo), and can be changed only in the PLAY screen of each mode.

If the tempo change value differs from the playback tempo, this means that the playback tempo has been changed temporarily. In other words, since the tempo change value has not been rewritten, this setting will be lost if you select another song or turn off the power. If you want to play back at this tempo the next time as well, you must re-save the song to disk. This will rewrite the tempo change value so that it matches the playback tempo.

Data Handled by the Beat Track

The Beat track records time signature data.

Beat Change

This specifies the time signature (Beat).

Viewing Sequencer Data (View)

Since a phrase track or pattern contains a large amount of sequencer data, the display may be cluttered and difficult to read. For this reason, the Fantom-X lets you specify the type(s) of sequencer data that will be displayed in the screen. This is convenient when you want to check or edit only a specific type of sequencer data.

1. Access the Microscope screen.
2. Press [F8 (View)].

The View Select window appears.



3. Use ▲ or ▼ to select the sequencer data that will be displayed.

Note:	Note messages. These MIDI messages represent notes.
Poly Aftertouch:	Polyphonic aftertouch. These MIDI messages apply aftertouch to individual keys.
Control Change:	Control change messages. These MIDI messages apply various effects such as modulation or expression.
Program Change:	Program change messages. These MIDI messages select sounds.
Channel Aftertouch:	Channel aftertouch messages. These MIDI messages apply aftertouch to an entire MIDI channel.
Pitch Bend:	Pitch bend messages. These MIDI messages change the pitch.
System Exclusive:	System exclusive messages. These MIDI messages are used to make settings unique to the Fantom-X, such as those for the sound parameters.
Pattern Call:	Pattern Call messages. This data causes a pattern to play back.
Tune Request:	This MIDI Message cause an analog synthesizer to tune it self.

4. Press [INC] or [DEC] to switch.

The message will be displayed if the check mark (✓) is assigned, and will not be displayed if the check mark is removed.

If you press [F6 (ALL OFF)], none of the sequencer data will be displayed.

If you press [F7 (ALL ON)], all of the sequencer data will be displayed.

5. Press [F8 (Close)] to close the View Select window.

Inserting Sequencer Data (Create)

You can insert new sequencer data into a desired location of a phrase track or pattern.



For details on the sequencer data that can be inserted, refer to “Sequencer Data Handled by a Phrase Track/Pattern” (p. 193).

1. Access the Microscope screen for the track or pattern into which you want to insert sequencer data (p. 192).
2. Press [F1 (CREATE)].

The Create Event window appears.

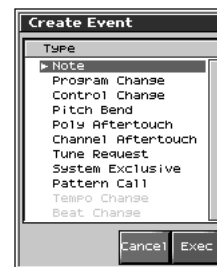

3. Press ▲ or ▼ to select the sequencer data that will be inserted.
4. Press [F8 (Exec)] to insert the performance data.
5. The sequencer data that was inserted will have the default parameter values, so edit them as necessary.



If you are not satisfied with the results of executing this operation, from the Song Edit screen, press [MENU], and from the Menu window that appears, select “Undo/Redo” to return to the state prior to execution (Undo/Redo). After executing Undo, you can use Redo to revert to the previous state. After executing Undo, you can execute Redo by performing the above procedure the above procedure once again.

Erasing Sequencer Data (Erase)

If desired, you can erase just an individual event of sequencer data. You can also use the same operation to erase individual items of data from the tempo track or beat track.

NOTE

It is not possible to erase the tempo change located at the beginning of the tempo track, the beat change located at the beginning of the beat track, or the pattern beat.

1. Access the Microscope screen for the track or pattern from which you want to erase sequencer data (p. 192).
2. Press ▲ or ▼ to move the cursor to the sequencer data that you want to erase.

TIP

To erase a multiple consecutive data, hold down [SHIFT] and press ▲ or ▼ to select the sequencer data.

3. Press [F2 (Erase)] to erase the sequencer data.

TIP

If you are not satisfied with the results of executing this operation, from the Song Edit screen, press [MENU], and from the Menu window that appears, select "Undo/Redo" to return to the state prior to execution (Undo/Redo). After executing Undo, you can use Redo to revert to the previous state. After executing Undo, you can execute Redo by performing the above procedure the above procedure once again.

Moving Sequencer Data (Move)

You can move an individual item of sequencer data to a different location. Data recorded in the tempo track or beat track can also be moved in the same way.

NOTE

It is not possible to move the tempo change located at the beginning of the tempo track, the beat change and key signature located at the beginning of the beat track, or the pattern beat.

1. Access the Microscope screen for the track or pattern whose data you want to move (p. 192).
2. Press ▲ or ▼ to move the cursor to the sequencer data that you want to move.

TIP

To move a multiple consecutive data, hold down [SHIFT] and press ▲ or ▼ to select the sequencer data.

3. Press [F3 (Move)].

The Move Event window appears.



4. Press ▲ or ▼ to move the cursor to the "measure," "beat," and "tick" fields.
5. Turn the VALUE dial or Press [INC]/[DEC] to specify the location to which the data will be moved.
6. Press [F8 (Exec)] to move the sequencer data.

TIP

If you are not satisfied with the results of executing this operation, from the Song Edit screen, press [MENU], and from the Menu window that appears, select "Undo/Redo" to return to the state prior to execution (Undo). After executing Undo, you can use Redo to revert to the previous state. After executing Undo, you can execute Redo by performing the above procedure the above procedure once again.

Copying Sequencer Data (Copy)

Sequencer data can be copied to the desired location. This is convenient when you want to use the same sequencer data at multiple locations. Data recorded in the tempo track or beat track can also be copied in this way.

1. Access the Microscope screen for the track or pattern whose sequencer data you want to copy (p. 192).
2. Press ▲ or ▼ to move the cursor to the sequencer data that you want to copy.
3. Press [F3 (COPY)].
4. Press [F4 (PLACE)].

The Place Event window appears.



5. Press ▲ or ▼ to move the cursor to the "measure," "beat," and "tick" fields.
6. Turn the VALUE dial or Press [INC]/[DEC] to specify the location to which the data will be copied.
7. Press [F8 (Exec)] to paste the data.

TIP

If you are not satisfied with the results of executing this operation, from the Song Edit screen, press [MENU], and from the Menu window that appears, select "Undo/Redo" to return to the state prior to execution (Undo/Redo). After executing Undo, you can use Redo to revert to the previous state. After executing Undo, you can execute Redo by performing the above procedure the above procedure once again.

Changing the Tempo Midway Through the Song

If you want to change the tempo midway through the song, insert a new Tempo Change into the tempo track. The song will play back at that tempo following the location at which the tempo change was inserted. However, if you want to create gradual tempo changes such as ritardando or accelerando, it is more convenient to use Tempo Recording (p. 171).

TIP

If you want to make the entire song faster or slower, modify the playback tempo in one of the PLAY screens.

1. Access the Microscope screen (p. 192). Press [F7 (Trk/Ch Select)], select “TEMPO” to “Track.”
2. Press [F1 (Create)].
The Create Event window appears.

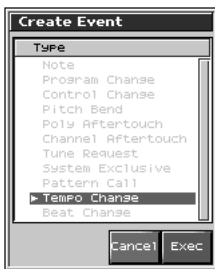

3. Press [F8 (Exec)].
The Create Position window will appear.
4. Use ◀ or ▶ to move the cursor to the “measure,” “beat,” and “tick” fields,
5. Turn the VALUE dial or Press [INC]/[DEC] to specify the location at which the data will be inserted.
6. Press [F8 (Exec)] to insert the tempo change data.
7. The inserted tempo change will have the default value, so modify it as necessary.

TIP

If you are not satisfied with the results of executing this operation, from the Song Edit screen, press [MENU], and from the Menu window that appears, select “Undo/Redo” to return to the state prior to execution (Undo/Redo). After executing Undo, you can use Redo to revert to the previous state. After executing Undo, you can execute Redo by performing the above procedure the above procedure once again.

Changing the Time Signature Midway Through the Song

If you want to change the time signature midway through the song, insert a new Beat Change. The song will play back using that time signature for measures following the inserted beat change.

NOTE

It is not possible to change the time signature in the middle of a measure. You must change the time signature at the beginning of a measure.

- If the time signature of the beat track differs from the pattern beat (p. 169) setting, the setting of the beat track will be used. For example, if a pattern with a 3/4 time signature is assigned in the middle of a 4/4 song, the pattern will not be aligned correctly with the other phrase tracks. To make this play back correctly, insert a 3/4 beat change into the beat track. To return the time signature to 4/4, insert a 4/4 beat change into the measure that follows the last measure of the pattern.

TIP

If you want to change the time signature from a measure that is later than the end of the song, or if it is ok to change the length of the song, you will find it more convenient to use the track edit Insert Measure function (p. 185).

1. Access the Microscope screen (p. 192). Press [F7 (Trk/Ch Select)], select “BEAT” to “Track.”
2. Press [F1 (Create)].
The Create Event window appears.

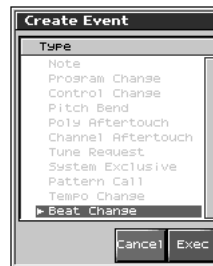

3. Press [F8 (Exec)].
The Create Position window will appear.
4. Use ◀ or ▶ to move the cursor to the “measure,” “beat,” and “tick” fields,
5. Turn the VALUE dial or Press [INC]/[DEC] to specify the location at which the data will be inserted.
6. Press [F8 (OK)] to insert the beat change data.
7. The inserted beat change will have the default values, so edit it as necessary.

TIP

If you are not satisfied with the results of executing this operation, from the Song Edit screen, press [MENU], and from the Menu window that appears, select “Undo/Redo” to return to the state prior to execution (Undo/Redo). After executing Undo, you can use Redo to revert to the previous state. After executing Undo, you can execute Redo by performing the above procedure the above procedure once again.

Assigning a Name to a Song (Song Name)

You can assign a song name to a song, or edit the song name. This song name is independent of the file name assigned when saving a song to user memory or memory card. Although you are not required to assign a song name, you can assign one using up to 15 characters, and you may find it a convenient way to store a title or memo that will help you organize your songs.

NOTE

Some commercially available Standard MIDI Files contain copyright data. It is not possible to assign or modify the song name for such songs.

1. **Access the Song Edit screen, and then load the song whose song name you want to assign (p. 177).**

2. **Press [F4 (Song Name)].**

The Song Name screen appears.



3. **Assign a song name to the song. (up to 15 characters).**



For details on assigning names, refer to “Assigning a Name” (p. 36)

4. **After you have assigned a name, press [Write].**

If you decide to cancel, press [F7 (Cancel)].

Saving/Loading a song (Save/Load)

Songs you record are initially held in Temporary Area. A song in Temporary Area will be lost when you turn off the power or when you load a different song. If you want to keep the song, you must save it to user memory or a memory card.

Conversely in order to edit a song (p. 177), you must first load it into Temporary Area.

Saving a Song (Save)

Basic Procedure

1. Press [SAVE/LOAD].

The Save/Load Menu screen will appear.



2. Press [F1 (Save S+S)]–[F3 (Save AllSmp)] to select the format in which you want to save the song.

Save Song+Samples: The Temporary Song will be saved in MRC Pro song format. A file name extension of “.SVQ” will automatically be added to the song. The song will include the data of the temporary area. All samples in sample memory will be saved.

Save Song: The Temporary Song will be saved in MRC Pro song format. A filename extension of “.SVQ” will automatically be added. The song will include the data of the temporary area.

Save all Samples: All samples in sample memory will be saved.

Parameter	Function buttons	Song	ALL-Samples
Save Song+Samples	[F1]	✓	✓
Save Song	[F2]	✓	–
Save all Samples	[F3]	–	✓

✓: Saving is possible

Data saved together with a song

The performances, patches, and system setup you are using at that time are saved together with the sequencer data.

The performances and patches saved along with the song are special data used to reproduce the song; they are separate from the user performances and user patches.

- * If you want to use these performances or patches in a different song, or without reference to a song, you'll need to save them in the user area.
- * Mastering Effect settings are not included in the data saved with a song. In order to completely reproduce the way in which the song played back at the time it was saved, you will also need to check the mastering settings.

Parameters included in System Setup

- Sound generator mode (Patch/Performance) and Patch/Performance numbers
- MFX 1–3/Chorus/Reverb switch
- The selection of whether Patch mode chorus/reverb will use the sound settings of the keyboard or of the pads
- Transpose and Octave Shift values
- The selection of the function controlled by D Beam
- All settings in the Arpeggio screen and the Arpeggio on/off setting
- All settings in the Rhythm Group screen
- All settings in the Chord Memory screen and the Chord Memory on/off setting
- The selection of whether the bender, modulation, D Beam, and knobs will be used with the keyboard or with the pads

Saving a Song with Samples (Save Song+Samples)

Here's how to save the Temporary Song along with all samples in sample memory and the current sound generator settings.

1. From the Save/Load Menu screen, press [F1 (Save S+S)]. The Song File Name screen will appear.



2. Assign a file name to the song (up to 8 characters). A file name extension of ".SVQ" will automatically be added to the song.



For details on assigning names, refer to "Assigning a Name" (p. 36)

NOTE

Song file names may not contain lowercase characters or certain symbols (" * + , . / ; < = > ? [\] |).

3. After you have assigned a name, press [F8 (Write)].

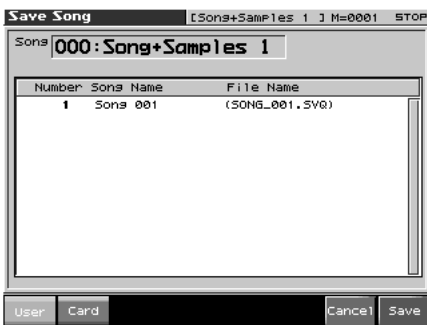

4. Press [F1 (User)] (User memory) or [F2 (Card)] (Memory card) to select the location where you want to save the song.

If you decide to cancel, press [F7 (Cancel)].

5. Press [F8 (Save)].

A screen will ask you for confirmation.

6. Press [F8 (Exec)] to execute.

* When samples are saved, they will automatically be overwritten onto the same numbers of the same bank in the sample list. The samples will be saved with a file name of "SMPL****.WAV (AIF)" in the "ROLAND/SMPL folder" of user memory or memory card. The number of the file name will correspond to the number in the sample list.

File Name and Song Name

MRC Pro songs and Standard MIDI Files have a song name in addition to a file name. The file name is used to distinguish between files, and must be assigned when you save a file. It will help you manage songs if you use the file name to distinguish between types of song, and use the song name to assign a title. Use the Song Name screen to assign a song name (p. 197).

If you assign a file name that is identical to a file name already existing in the user area or memory card, and attempt to save, a message of "File "****" Already Exists! Over Write Sure?" will appear, asking you for confirmation. If it is OK to overwrite the existing file, press [F8 (OK)]. If you decide to cancel the Save operation, press [F7 (Cancel)].

If you attempt to save data on a memory that was not formatted by the Phantom-X, a message of "Unformatted!" (memory card has not been formatted) will appear. Please format the memory card on the Phantom-X (p. 224).

Saving a Song (Save Song)

Here's how to save the Temporary Song with the current sound generator settings.

1. From the Save/Load Menu screen, press [F2 (Save Song)]. The Song File Name screen will appear.

2. Assign a file name to the song (up to 8 characters). A file name extension of ".SVQ" will automatically be added to the song.



For details on assigning names, refer to "Assigning a Name" (p. 36)

NOTE

Song file names may not contain lowercase characters or certain symbols (" * + , . / ; < = > ? [\] |).

3. After you have assigned a name, press [F8 (Write)].



Saving/Loading a song (Save/Load)

4. Press **[F1 (User)] (User memory)** or **[F2 (Card)] (Memory card)** to select the location where you want to save the song.

If you decide to cancel, press **[F7 (Cancel)]**.

5. Press **[F8 (Save)]**.

A screen will ask you for confirmation.

If you decide to cancel, press **[F7 (Cancel)]**.

6. Press **[F8 (Exec)]** to execute.

Even if you save your song using "Save," it cannot be played back by a sequencer other than the Fantom-X's own sequencer. If you want to play back your song on a sequencer other than the Fantom-X's sequencer, you must save the song as an SMF file. Also at this time, you must record the appropriate bank selects and program numbers so that the correct sounds will be played.

The performance settings will be saved in the state they were in when you executed Save. This means that if the performance changed during the song, and you saved the song in that state when you finished recording, the state in which recording began will not be saved. In other words when you play back the song from the beginning, it will begin with the performance sounds that were being used at the point where you saved. If you change the performance during the song, you must use the Microscope screen etc. to insert the appropriate bank select and program number at the beginning of the song to specify the performance with which you began recording it (p. 192).

Saving Samples (Save All Samples)

Here's how to save all samples from sample memory into user memory or a memory card.

1. From the Save/Load Menu screen, press **[F3 (Save AllSmpl)]**.

A screen will ask you for confirmation.

If you decide to cancel, press **[F7 (Cancel)]**.

2. Press **[F8 (Exec)]** to execute.

* When samples are saved, they will automatically be overwritten onto the same number of the same bank in the sample list.

Saving a Song as an SMF File (Save as SMF)

Here's how to convert and save an Temporary Song as an SMF file.

1. From the Save/Load Menu screen, press **[F4 (Save as SMF)]**.

The Save As SMF screen will appear.

2. Assign a file name to the song.



For details on assigning names, refer to "Assigning a Name" (p. 36)

NOTE

Song file names may not contain lowercase characters or certain symbols (" * + , . / : ; < = > ? [\] |).

3. After you have assigned a name, press **[F8 (Write)]**.

4. Press either **[F1 (User)] (user memory)** or **[F2 (Card)] (memory card)** to select the save-destination.



5. Press either **[F5 (Format 0)]** or **[F6 (Format 1)]** to select the format for saving.

Format 0: Convert the song to a Format 0 Standard MIDI File (all performance data is saved in one phrase track) and save it to disk. An extension of ".MID" will be added automatically.

Format 1: Convert the song to a Format 1 Standard MIDI File (performance data is saved in more than one phrase track) and save it to disk. An extension of ".MID" will be added automatically.

6. Press **[F8 (Save As SMF)]**.

A screen will ask for confirmation.

7. Press **[F8 (Exec)]** to execute.

* The filename extension will be ".MID" whether you select "Save SMF (Format 0)" or "Save SMF (Format 1)." The two cannot be distinguished in this way.

When you save data in SMF format, the sound setup data will not be saved. In order to ensure that the correct sounds are played, you must record the appropriate bank select and program numbers (p. 192).

If you assign a file name that is identical to one already existing in the user area or the memory card, a message of "File ***** Already Exists! Over Write Sure?" will ask you for confirmation when you attempt to save the file. If it is OK to overwrite the existing file, press [F8 (OK)]. If you decide not to save the file, press [F7 (Cancel)].

If you attempt to save data to a memory card that was not formatted on the Fantom-X, a message of "Unformatted!" (the memory card has not been formatted) will appear. Please format the memory card on the Fantom-X (p. 224).

Loading a Song (Load)

Basic Procedure

1. Press [SAVE/LOAD].

The Save/Load Menu screen will appear.



2. Press [F5 (Load S+S)]-[F7 (Load AllSmp1)] to select the format in which you want to load the song.

Load Song+Samples: Loads a song into Temporary Area. All samples will be loaded into sample memory.

Load Song: Loads a song into Temporary Area.

Load all Samples: Loads all samples into sample memory.

Parameter	Function buttons	Song	ALL-Samples
Load Song+Samples	[F5]	✓	✓
Load Song	[F6]	✓	-
Load all Samples	[F7]	-	✓

✓: Loading is possible

* A song saved on the Fantom-X (.SVQ) also includes the data for the sound generator's temporary area.

Loading a Song with Samples (Load Song+Samples)

Here's how you can load a song into Temporary Area and all samples into sample memory.

1. From the Save /Load Menu screen, press [F5 (Load S+S)].

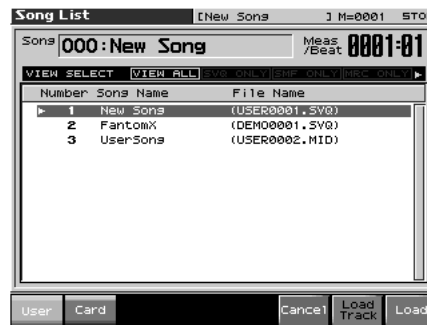

* By pressing ◀ or ▶ in the above screen, you can specify the type of songs that will be displayed. If various types of songs are saved together, it will be easier to find the desired song if you restrict the displayed file types in this way.

- **VIEW ALL:** all songs will be displayed
- **SVQ ONLY:** only SVQ files will be displayed
- **SMF:** only Standard MIDI Files will be displayed
- **MRC:** only MRC files will be displayed

2. Press either [F1 (User)] or [F2 (Card)] to select the load-destination, and use ▲ ▼ to select a song.
If you decide to cancel, press [F7 (Cancel)].

3. Press [F8 (Load)].

A screen will ask you for confirmation.

4. Press [F8 (Exec)] to execute.

Saving/Loading a song (Save/Load)

Loading a song (Load Song)

Here's how you can load a song into Temporary Area.

1. From the Save/Load Menu screen, press [F6 (Load Song)].



* By pressing ◀ or ▶ in the above screen, you can specify the type of songs that will be displayed. If various types of songs are saved together, it will be easier to find the desired song if you restrict the displayed file types in this way.

- **VIEW ALL:** all songs will be displayed
 - **SVQ ONLY:** only SVQ files will be displayed
 - **SMF:** only Standard MIDI Files will be displayed
 - **MRC:** only MRC files will be displayed
2. Press either [F1 (User)] or [F2 (Card)] to select the load-destination, and use ▲ ▼ to select a song.
If you decide to cancel, press [F7 (Cancel)].
 3. Press [F8 (Load)].
A screen will ask you for confirmation.
 4. Press [F8 (Exec)] to execute.

Loading Samples (Load All Samples)

Here's how you can load all samples from user memory or memory card into sample memory.

1. From the Save/Load Menu screen, press [F7 (Load AllSmpl)].
A screen will ask you for confirmation.
If you decide to cancel, press [F7 (Cancel)].
2. Press [F8 (Exec)] to execute.

Importing a WAV/AIFF File (Import Audio)

Here's how you can load an audio file (WAV/AIFF) into sample memory as a sample.

In order for audio data to be imported, the data (WAV/AIFF) must be in the following location of user memory or a memory card.

/TMP/AUDIO_IMPORT folder

* "/" indicates a directory level.

Use USB storage mode (p. 219) to place the files from the computer in the above location. Alternatively, you can place the data in a memory card and use a card reader.

1. Press [Save/Load].
2. Press [F8 (Import Audio)].
3. Press [F1 (User)] or [F2 (Card)] to select the import-destination area.
[F1 (User)]: Import from user memory.
[F2 (CARD)]: Import from a memory card.
4. Press ▲ or ▼, then select the file that you want to import.
If you want to select two or more samples, press [F5 (Mark Set)] to add a check mark (✓) to the files that you want to select. To remove the check mark, press [F4 (Mark Clear)].
If you hold down [SHIFT] and press [F5 (Mark Set All)], a check mark will be added to all files of the selected bank. If you hold down [SHIFT] and press [F4 (Mark Clr All)], check marks will be removed from all selected files.
5. Press [F8 (Import)].
A message will ask you for confirmation.
* To cancel, press [F7 (Cancel)].
6. Press [F8 (Exec)].
The file will be imported, and the Sample List screen will appear.
* To cancel, press [F7 (Cancel)].

MEMO

The imported file will be added to the sample list as a sample. This sample is temporary, and will be lost when you turn off the power. If you want to keep it, press [WRITE] to save the data (p. 159).

Playing a Phrase at the Touch of a Finger (RPS Function)

The **RPS (Realtime Phrase Sequence)** function lets you assign patterns to the keyboard or Pad, and play a pattern by pressing a single note.

For example, a complex phrase that would be difficult to play live can be assigned to a note of the keyboard, and played with one finger at the appropriate moment.

Since up to eight patterns can be playing at once, you can create patterns for separate instruments such as drums, bass, and keyboard, and combine them to create a new song. This performance can also be recorded, allowing you to use it in a way similar to phrase sampling.

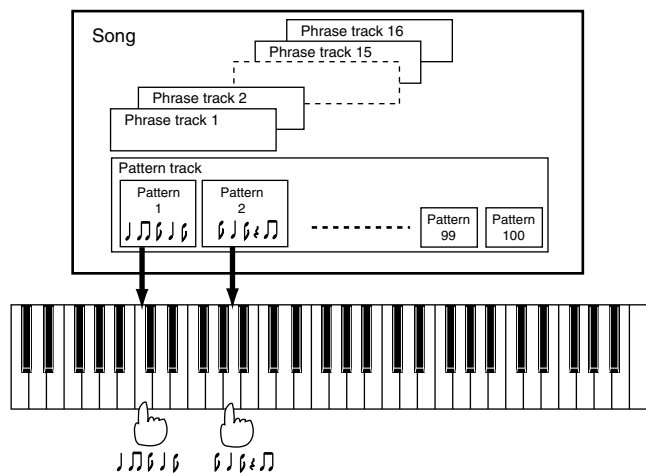

Before You Use the RPS Function

Record a Pattern

Before you use the RPS function, you must record the desired phrase in a pattern. For details on recording, refer to “**Recording Your Performance as You Play It (Realtime Recording)**” (p. 170) or “**Inputting Data One Step at a Time (Step Recording)**” (p. 174).

NOTE

Only note messages should be recorded in a pattern. If a large amount of MIDI data is recorded in a pattern, using RPS to play back the pattern can cause notes to be delayed. MIDI messages other than note messages should be recorded in a phrase track.

Settings for the RPS Function

You can assign a pattern to each note of the keyboard, and specify how the pattern will be played. These settings are made independently for each song, and will be saved when you save the song in MRC Pro song format.

NOTE

In order to make RPS settings, you must first load a song into Temporary Area.

1. Holding down [SHIFT] and pressing [RPS].

The RPS Setup screen appears.

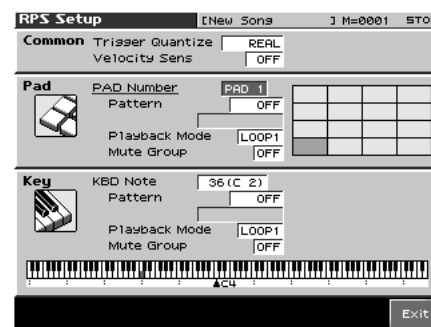

In this screen you can set various parameters related to the RPS function.

2. Use [CURSOR] to move the cursor to each parameter, and turn the VALUE dial or press [INC]/[DEC] to make the setting.

MEMO

Pattern parameter, Playback Mode parameter, and Mute Group parameter are set for each key. Although the Fantom-X6 has a 61-note keyboard and the Fantom-X7 has a 76-note keyboard, you can also make settings for all keys in the range of E0 to G9. Setting for the Trigger Quantize parameter is for the entire song.

• Trigger Quantize

This parameter specifies how pattern playback is to begin when a key is pressed during song playback or recording.

Value

- REAL:** The pattern will begin playing at the moment you press the key.
- BEAT:** If the song is being played or recorded, the pattern will begin playing at the beginning of the next beat if you press the key in the middle of the beat.
- MEASURE:** If the song is being played or recorded, the pattern will begin playing at the beginning of the next measure if you press the key in the middle of the measure.

Playing a Phrase at the Touch of a Finger (RPS Function)

- **Velocity Sens (Velocity Sensitivity)**

Turn this "OFF" if you want the pattern to play back at the volume at which it was recorded.

If you want to vary the pattern playback volume according to the strength with which you pressed the key, select either "LOW," "MID," or "HIGH."

Value: OFF, LOW, MID, HIGH

- **PAD Number**

Specify the pad number to which the pattern is to be assigned. You can also specify a pad directly by pressing it.

- **Keyboard Note**

Specify the key to which the pattern will be assigned. You can also specify this by pressing a key on the keyboard.

- **KBD/PAD Pattern**

Select the pattern number that will be assigned to the key/pad. The name of the selected pattern will be displayed below the pattern number.

Select "OFF" for keys to which you do not want to assign a pattern. If you select "STOP," that key will be a Stop Trigger key/pad that stops the currently playing patterns.

When assigning a number to a pad, simply press PAD and the cursor will move to "Pattern."

Valid Settings: STOP, OFF, PTN001-PTN100

- **KBD/PAD Playback Mode**

Specify how the pattern will be played.

Value

LOOP1: The pattern will play back repeatedly as long as the key is held down.

LOOP2: The pattern will play back repeatedly. To stop playback, press a Stop Trigger key or press the same key once again.

ONCE: The pattern will play back once.

- **KBD/PAD Mute Group**

This function lets you prevent patterns of the same group from sounding together. For example, a fill-in and bridge should never be played at the same time, and to ensure that this does not occur, you can set the fill-in and bridge to the same mute group number.

Thirty-one mute groups can be specified. Select "OFF" if you do not want to use a mute group for a pattern.

Value: OFF, 1-31

3. **When you are finished making settings, press [F8 (Exit)] to return to the Song Play screen.**

Using the RPS Function While You Perform

Normally, when playing patterns individually, the song containing the patterns must be loaded into Temporary Area. However, when using the RPS function to play back patterns, you can use Quick Play.

1. **Make sure that the preparations for using the RPS function have been made correctly.**

2. **Access the PLAY screen for the mode in which you want to perform.**

3. **Press [RPS] so the button is lit.**

The RPS function will be turned on, and you will be able to perform using RPS.



4. **Press [PLAY] to play back the song.**

TIP

You must play back the song if you want patterns to play back in synchronization with the song, or if you want multiple patterns to play in synchronization.

- If the song is not playing, the pattern will begin playing the instant you press the key, regardless of the Trigger Quantize parameter setting.
- The pattern will be played back according to the time signature of the song (beat track). This means that if the phrase track contains no sequencer data, the song will not play, and it will not be possible to play back patterns in synchronization. In such cases, you can insert several blank measures into a phrase track, and play them as a loop.

5. **Press a key or pad to which a pattern is assigned, making the pattern play.**

If you want to stop playback midway through the pattern, press the Stop Trigger key. Alternatively if the Playback Mode parameter is set to "LOOP2," you can stop the pattern playback by pressing the same key once again.

MEMO

Up to eight patterns can play back simultaneously.

Recording a Performance Using the RPS Function

A performance that uses the RPS function can be recorded in real time in the same way as a conventional performance. This provides an easy way to remix patterns and create a song.

MEMO

If you use the RPS function during realtime recording, the pattern performance will be recorded just as it occurs.

1. **Make sure that preparations for the RPS function have been made correctly.**
2. **Access the PLAY screen for the mode in which you want to perform.**
3. **Press [RPS] to turn on the RPS function.**
4. **Press [REC].**

The [REC] indicator will blink, and the Realtime Rec Standby window appears. In this window you can make various settings for realtime recording.

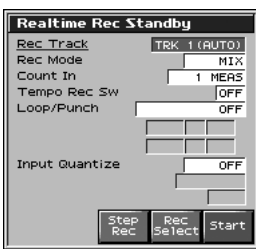

5. **Specify how recording is to take place.**

cf. ➔

For details on these settings, refer to “Recording Your Performance as You Play It (Realtime Recording)” (p. 170).

6. **Press [PLAY].**
The Recording Standby window will close, the [REC] indicator will change from blinking to lit, and recording will begin.
7. **Press a key or pad to which a pattern is assigned.**
The assigned patterns will be played back according to the keys or pads you press, and their performances will be recorded.

NOTE

If the Count In parameter is set to “WAIT NOTE” in the Recording Standby window, recording will not begin even if you press a key that is assigned to a pattern, or a key that is assigned as a Stop Trigger key.

8. **When you are finished recording, press [STOP].**
The [REC] indicator will go dark.

Adding Effects

This section explains the procedures and settings for applying effects in each mode.



For details of the Fantom-X's onboard effects, refer to "About the Onboard Effects" (p. 29).

Turning Effects On and Off

The Fantom-X's onboard effects can be turned on/off as a whole. Turn these settings OFF when you wish to listen to the unprocessed sound as you create a sound, or when you wish to use external effects processors instead of the built-in effects.

NOTE

Effect ON/OFF settings are global Fantom-X settings. These settings cannot be made for each Patch or Performance individually.

1. Press [EFFECTS] to access the Effects screen.

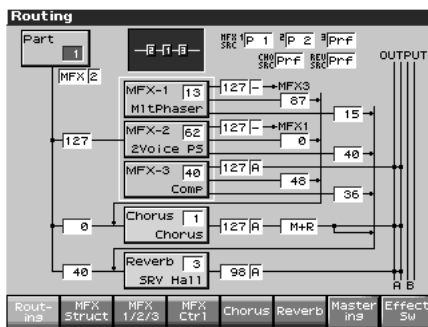

2. Press [F8 (Effect Sw)].

The Effect Sw window appears.

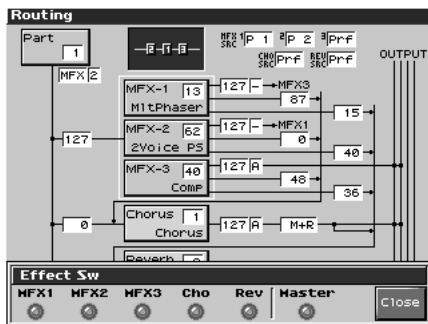

3. Use [F1 (MFX1)]–[F6 (MASTER)] to turn each effect switch on/off. The switch will turn on/off each time you press the button.

4. Press [F8 (Close)] to return to the previous screen. When you return to the Play screen, the settings will be displayed in the following area.

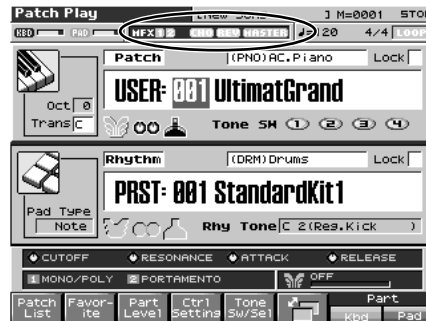

Making Effect Settings

1. In the appropriate mode, select the sound to which you want to apply effects.
2. Press [EFFECTS] to access the Effects screen.
3. Press one of the [F1 (Routing)]–[F7 (Mastering)] tabs to select the effect that you want to edit.

* You can also do this by pressing [MENU] from the Effect screen.

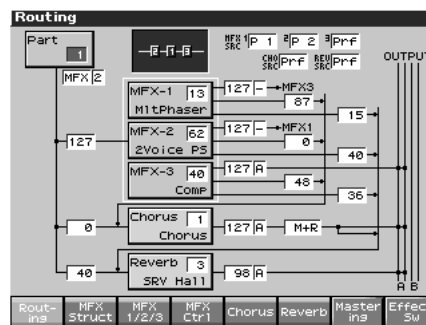

In Performance mode, each time you press the [F3 (MFX1/2/3)] button, it will alternate between 1, 2, and 3. In Patch mode, each time you press the [F3 (MFX1/2)] button, it will alternate between 1 and 2.

4. Use [CURSOR] to move the cursor to the parameter you wish to modify.
5. Turn the VALUE dial or press [INC]/[DEC] to get the value you want.
6. Press [EXIT] to return to the previous screen.

* You cannot edit the effect settings for patches of the GM group.

Applying Effects in Patch Mode

In Patch mode you can use two multi-effects (MFX1, MFX2), one chorus, and one reverb. Multi-effect 1 (MFX1) will operate according to the effect settings of the patch or rhythm set assigned to the Keyboard part. Multi-effect 2 (MFX2) will operate according to the effect settings of the patch or rhythm set assigned to the Pad part. Chorus and reverb will both operate according to the settings of the patch or rhythm set assigned to either the Keyboard part or the Pad part.

Specifying How the Sound Will Be Output (Routing)

Here you can make overall settings for effects, and the output destination and level of each signal.

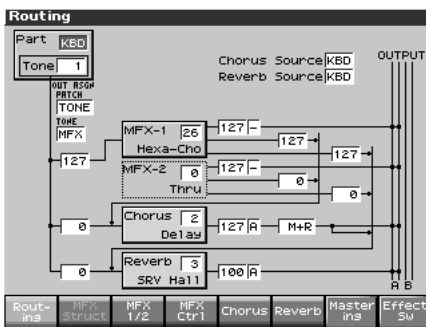

cf.

For details on these settings, refer to “Making Effect Settings” (p. 206).

Signal Flow Diagram and Parameters

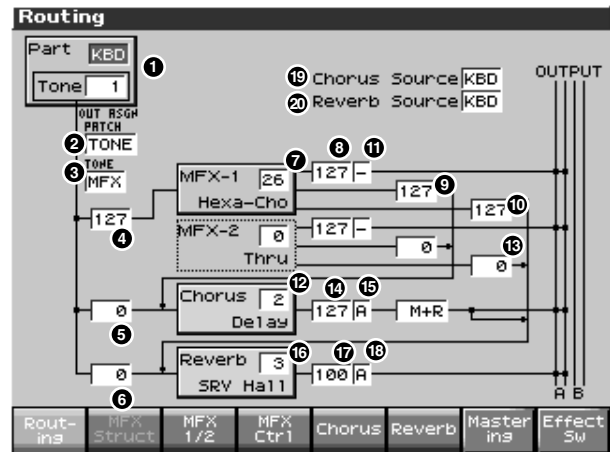

1 Part Select

Select the part for which you want to make settings.

Value: KBD, PAD

1 Tone Select

Select the tone for which you want to make settings.

Value: 1–4

* This parameter is **Rhythm Key Select** when a rhythm set is being selected. You can select the rhythm tone (A0–C8) for which you want to make settings.

2 Patch Output Assign

Specifies how the direct sound of each patch will be output.

Value:

MFX: Output in stereo through multi-effects. You can also apply chorus or reverb to the sound that passes through multi-effects.

A, B: Output to the OUTPUT A (MIX) jack or OUTPUT B jack in stereo without passing through multi-effects.

1–4: Output to the INDIVIDUAL 1–4 jacks in mono without passing through multi-effects.

TONE: Outputs according to the settings for each tone.

NOTE

If you've made settings so that sounds are separately routed to the INDIVIDUAL 1 jack and INDIVIDUAL 2 jack, but no plug is actually inserted in the INDIVIDUAL 2 jack, the sounds routed to INDIVIDUAL 1 and INDIVIDUAL 2 will be mixed and output from the INDIVIDUAL 1 jack.

- This parameter is **Rhythm Output Assign** when a rhythm set is being selected. You can specify for each rhythm set how the direct sound will be output.

MEMO

If the Mix/Parallel parameter is set to “MIX,” all sounds are output from the OUTPUT A (MIX) jacks in stereo (p. 230).

3 Tone Output Assign

Specifies how the direct sound of each tone will be output.

Value:

MFx: Output in stereo through multi-effects. You can also apply chorus or reverb to the sound that passes through multi-effects.

A, B: Output to the OUTPUT A (MIX) jack or OUTPUT B jack in stereo without passing through multi-effects.

1–4: Output to the INDIVIDUAL 1–4 jacks in mono without passing through multi-effects.

NOTE

If the Patch Output Assign (2) is set to anything other than “TONE,” these settings will be ignored.

- When the Structure Type parameter has a setting of Type “2”–“10,” the outputs of tones 1 and 2 will be combined with tone 2, and the outputs of tones 3 and 4 will be combined with tone 4. For this reason, tone 1 will follow the settings of tone 2, and tone 3 will follow the settings of tone 4 (p. 63).
- If you've made settings so that sounds are separately routed to the INDIVIDUAL 1 jack and INDIVIDUAL 2 jack, but no plug is actually inserted in the INDIVIDUAL 2 jack, the sounds routed to INDIVIDUAL 1 and INDIVIDUAL 2 will be mixed and output from the INDIVIDUAL 1 jack.

MEMO

If the Mix/Parallel parameter is set to “MIX,” all sounds are output from the OUTPUT A (MIX) jacks in stereo (p. 230).

TIP

If you've set Tone Out Assign to “MFx,” set the MFx Output Assign parameter (11) to specify the output destination of the sound that has passed through the multi-effects.

- Chorus and reverb are output in mono at all times.
- The output destination of the signal after passing through the chorus is set with the Chorus Output Select (13) and the Chorus Output Assign (15).
- The output destination of the signal after passing through the reverb is set with the Reverb Output Assign (18).

4 Tone Output Level

Set the level of the signal that is sent to the output destination specified by Output Assign (2 , 3).

Value: 0–127

5 Tone Chorus Send Level

Sets the level of the signal sent to chorus for each tone.

Value: 0–127

6 Tone Reverb Send Level

Sets the level of the signal sent to reverb for each tone.

Value: 0–127

7 MFx Type (Multi-Effects Type)

Use this parameter to select from among the 78 available multi-effects. For details on multi-effects parameters, refer to “Multi-Effects Parameter” (p. 270).

Value: 0 (Through)–78

8 MFx Output Level (Multi-Effects Output Level)

Adjusts the volume of the sound that has passed through the multi-effects.

Value: 0–127

9 MFx Chorus Send Level (Multi-Effects Chorus Send Level)

Adjusts the amount of chorus for the sound that passes through multi-effects. If you don't want to add the Chorus effect, set it to “0.”

Value: 0–127

10 MFx Reverb Send Level (Multi-Effects Reverb Send Level)

Adjusts the amount of reverb for the sound that passes through multi-effects. If you don't want to add the Reverb effect, set it to “0.”

Value: 0–127

11 MFx Output Assign (Multi-Effects Output Assign)

Adjusts the output destination of the sound that has passed through the multi-effects.

Value

A: Output to the OUTPUT A (MIX) jacks in stereo.

B: Output to the OUTPUT B jacks in stereo.

MEMO

If the Mix/Parallel parameter is set to “MIX,” all sounds are output from the OUTPUT A (MIX) jacks in stereo (p. 230).

12 Chorus Type

Selects either chorus or delay.

Value

0 (Off): Neither chorus or delay is used.

1 (Chorus): Chorus is used.

2 (Delay): Delay is used.

3 (GM2 Chorus): General MIDI 2 chorus

13 Chorus Output Select

Specifies how the sound routed through chorus will be output.

Value

- MAIN:** Output to the OUTPUT jacks in stereo.
- REV:** Output to reverb in mono.
- M+R:** Output to the OUTPUT jacks in stereo, and to reverb in mono.



When set to “MAIN” or “M+R,” the OUTPUT jack from which the sound is output is set in Chorus Output Assign (15).

14 Chorus Level

Adjusts the volume of the sound that has passed through chorus.

Value: 0–127

15 Chorus Output Assign

Selects the pair of OUTPUT jacks to which the chorus sound is routed when Chorus Output Select (13) is set to “MAIN” or “M+R.”

Value

- A:** Output to the OUTPUT A (MIX) jacks in stereo.
- B:** Output to the OUTPUT B jacks in stereo.

NOTE

When Chorus Output Select (13) is set to “REV,” this setting will have no effect.

16 Reverb Type

Selects the type of reverb.

Value

- 0 (Off):** Reverb is not used.
- 1 (Reverb):** Normal reverb
- 2 (SRV Room):** This reverb simulates typical room acoustic reflections.
- 3 (SRV Hall):** This reverb simulates typical concert hall acoustic reflections.
- 4 (SRV Plate):** This reverb simulates a reverb plate, a popular type of artificial reverb unit that derives its sound from the vibration of a metallic plate. You can also achieve unusual metallic-sounding reverbs using “SRV Plate.”
- 5 (GM2 Reverb):** General MIDI 2 reverb

17 Reverb Level

Adjusts the volume of the sound that has passed through reverb.

Value: 0–127

18 Reverb Output Assign

Specifies how the sound routed through reverb will be output.

Value

- A:** Output to the OUTPUT A (MIX) jacks in stereo.
- B:** Output to the OUTPUT B jacks in stereo.

MEMO

If the Mix/Parallel parameter is set to “MIX,” all sounds are output from the OUTPUT A (MIX) jacks in stereo (p. 230).

19 Chorus Source

Selects chorus parameter settings. If you want to use the settings of the patch or rhythm set assigned to the Keyboard part, select “KBD.” If you want to use the settings of the patch or rhythm set assigned to the Pad part, select “PAD.”

Value: KBD, PAD

20 Reverb Source

Selects reverb parameter settings. If you want to use the settings of the patch or rhythm set assigned to the Keyboard part, select “KBD.” If you want to use the settings of the patch or rhythm set assigned to the Pad part, select “PAD.”

Value: KBD, PAD

Applying Effects in Performance Mode

In Performance mode you can use three multi-effects (MFX1, MFX2, MFX3), one chorus, and one reverb. For each of the three multi-effects, the chorus, and the reverb, you can specify whether it will operate according to the effect settings of the performance, or according to the effect settings of the patch or rhythm set assigned to the part you specify. The three multi-effects can be used independently, or you can connect two or three of them in series.

Specifying How the Sound Will Be Output (Routing)

Here you can make overall settings for effects, and the output destination and level of each signal.

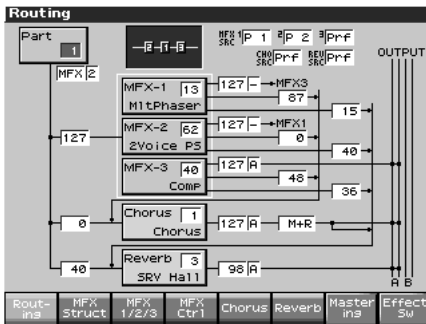

cf.

For details on these settings, refer to “Making Effect Settings” (p. 206).

Signal Flow Diagram and Parameters

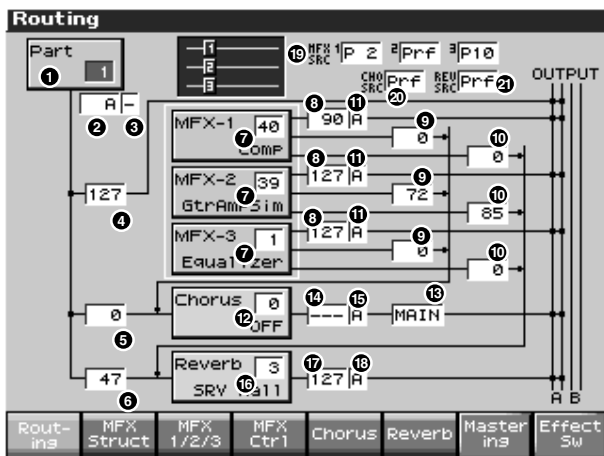

1 Part Select

Select the part for which you want to make settings.

Value: 1–16

2 Part Output Assign

Specifies for each part how the direct sound will be output.

Value

MFX: Output in stereo through multi-effects. You can also apply chorus or reverb to the sound that passes through multi-effects.

A, B: Output to the OUTPUT A (MIX) jack or OUTPUT B jack in stereo without passing through multi-effects.

1–4: Output to the INDIVIDUAL 1–4 jacks in mono without passing through multi-effects.

PAT: The part’s output destination is determined by the settings of the patch or rhythm set assigned to the part.

NOTE

If you’ve made settings so that sounds are separately routed to the INDIVIDUAL 1 jack and INDIVIDUAL 2 jack, but no plug is actually inserted in the INDIVIDUAL 2 jack, the sounds routed to INDIVIDUAL 1 and INDIVIDUAL 2 will be mixed and output from the INDIVIDUAL 1 jack.

MEMO

If the Mix/Parallel parameter is set to “MIX,” all sounds are output from the OUTPUT A (MIX) jacks in stereo (p. 230).

TIP

If you’ve set Tone Out Assign to “MFX,” set the MFX Output Assign parameter (11) to specify the output destination of the sound that has passed through the multi-effects.

- Chorus and reverb are output in mono at all times.
- The output destination of the signal after passing through the chorus is set with the Chorus Output Select (13) and the Chorus Output Assign (15).
- The output destination of the signal after passing through the reverb is set with the reverb Output Assign (18).

3 Part Output MFX Select (Part Output Multi-Effects Select)

Of the three systems of multi-effects that can be used simultaneously, specify which multi-effects will be used.

Value: 1–3(MFX-1–MFX-3)

4 Part Output Level

Set the level of the signal that is sent to the output destination specified by Part Output Assign (2).

Value: 0–127

5 Part Chorus Send Level

Sets the level of the signal sent to chorus for each part.

Value: 0–127

6 Part Reverb Send Level

Sets the level of the signal sent to reverb for each part.

Value: 0–127

MEMO

For the following parameters 7 – 11, settings can be made individually for three systems multi-effects (MFX1–MFX3).

7 MFX Type (Multi-Effects Type)

Use this parameter to select from among the 78 available multi-effects. For details on multi-effects parameters, refer to “Multi-Effects Parameter” (p. 270).

Value: 0 (Through)–78

8 MFX Output Level (Multi-Effects Output Level)

Adjusts the volume of the sound that has passed through the multi-effects.

Value: 0–127

9 MFX Chorus Send Level (Multi-Effects Chorus Send Level)

Adjusts the amount of chorus for the sound that passes through multi-effects. If you don’t want to add the Chorus effect, set it to “0.”

Value: 0–127

10 MFX Reverb Send Level (Multi-Effects Reverb Send Level)

Adjusts the amount of reverb for the sound that passes through multi-effects. If you don’t want to add the Reverb effect, set it to “0.”

Value: 0–127

11 MFX Output Assign (Multi-Effects Output Assign)

Adjusts the output destination of the sound that has passed through the multi-effects.

Value

A: Output to the OUTPUT A (MIX) jacks in stereo.

B: Output to the OUTPUT B jacks in stereo.

MEMO

If the Mix/Parallel parameter is set to “MIX,” all sounds are output from the OUTPUT A (MIX) jacks in stereo (p. 230).

MEMO

For some settings of MFX Structure, the sound that passes through the multi-effect will be sent to a different multi-effect, and the MFX Output Assign setting will be ignored.

12 Chorus Type

Selects either chorus or delay.

Value

0 (Off): Neither chorus or delay is used.

1 (Chorus): Chorus is used.

2 (Delay): Delay is used.

3 (GM2 Chorus): General MIDI 2 chorus

13 Chorus Output Select

Specifies how the sound routed through chorus will be output.

Value

MAIN: Output to the OUTPUT jacks in stereo.

REV: Output to reverb in mono.

M+R: Output to the OUTPUT jacks in stereo, and to reverb in mono.

TIP

When set to “MAIN” or “M+R,” the OUTPUT jack from which the sound is output is set in Chorus Output Assign (15).

14 Chorus Level

Adjusts the volume of the sound that has passed through chorus.

Value: 0–127

15 Chorus Output Assign

Selects the pair of OUTPUT jacks to which the chorus sound is routed when Chorus Output Select (13) is set to “MAIN” or “M+R.”

Value

A: Output to the OUTPUT A (MIX) jacks in stereo.

B: Output to the OUTPUT B jacks in stereo.

NOTE

When Chorus Output Select (13) is set to “REV,” this setting will have no effect.

MEMO

If the Mix/Parallel parameter is set to “MIX,” all sounds are output from the OUTPUT A (MIX) jacks in stereo (p. 230).

16 Reverb Type

Selects the type of reverb.

Value

- 0 (Off):** Reverb is not used.
- 1 (Reverb):** Normal reverb
- 2 (SRV Room):** This reverb simulates typical room acoustic reflections.
- 3 (SRV Hall):** This reverb simulates typical concert hall acoustic reflections.
- 4 (SRV Plate):** This reverb simulates a reverb plate, a popular type of artificial reverb unit that derives its sound from the vibration of a metallic plate. You can also achieve unusual metallic-sounding reverbs using "SRV Plate."
- 5 (GM2 Reverb):** General MIDI 2 reverb

17 Reverb Level

Adjusts the volume of the sound that has passed through reverb.

Value: 0–127

18 Reverb Output Assign

Specifies how the sound routed through reverb will be output.

Value

- A:** Output to the OUTPUT A (MIX) jacks in stereo.
- B:** Output to the OUTPUT B jacks in stereo.

19 MFX1–3 Source (Multi-Effects 1 Source)

Selects the multi-effects parameter settings that will be used by the performance. If you wish to use the performance settings, select "PRF." If you wish to use the settings of the patch/rhythm set assigned to one of the parts, select the part number.

Value: PRF, P1–P16

When Patch or Rhythm Set Settings Are Selected

When the patch or rhythm set's multi-effects settings are selected, those settings are shown in each of the performance's multi-effects setting screens, and the settings can be then be changed as well. Changes to patch or rhythm set multi-effects parameter settings are lost when another patch or rhythm set is selected. To keep the modified settings, save the patch/rhythm set settings (p. 59, p. 86).

20 Chorus Source

Selects the chorus parameter settings that will be used by the performance. If you wish to use the performance settings, select "PRF." If you wish to use the settings of the patch/rhythm set assigned to one of the parts, select the part number.

Value: PRF, P1–P16

When Patch or Rhythm Set Settings Are Selected

When the patch or rhythm set's chorus settings are selected, those settings are shown in each of the performance's chorus setting screens, and the settings can be then be changed as well. Changes to patch or rhythm set chorus parameter settings are lost when another patch or rhythm set is selected. To keep the modified settings, save the patch/rhythm set settings (p. 59, p. 86).

21 Reverb Source

Selects the reverb parameter settings that will be used by the performance. If you wish to use the performance settings, select "PRF." If you wish to use the settings of the patch/rhythm set assigned to one of the parts, select the part number.

Value: PRF, P1–P16

When Patch or Rhythm Set Settings Are Selected

When the patch or rhythm set's reverb settings are selected, those settings are shown in each of the performance's reverb setting screens, and the settings can be then be changed as well. Changes to patch or rhythm set reverb parameter settings are lost when another patch or rhythm set is selected. To keep the modified settings, save the patch/rhythm set settings (p. 59, p. 86).

Making Multi-Effects Settings (MFX1–3)

Here we will explain how to make multi-effects settings in Performance mode.



Each time you press the [F3 (MFX1/2/3)] button, it will alternate between 1, 2, and 3.

cf.

For details on these settings, refer to “Making Effect Settings” (p. 206)

Type (Multi-Effects Type)

Use this parameter to select from among the 78 available multi-effects. For details on multi-effects parameters, refer to “Multi-Effects Parameter” (p. 270).

Value: 00 THROUGH– 78 SYNPATHETHIC RESONANCE
In this setting screen, you can edit the parameters of the multi-effects that is selected by the Multi-effects Type setting. For details on the parameters that can be edited, refer to “Multi-Effects Parameter” (p. 270).

TIP

You can use the REALTIME CONTROL knobs to edit up to four of the most important parameters, which have been pre-selected for each type of multi-effect. The knobs shown in the screen correspond to the Realtime Control knobs. When you enter the MFX 1–3 screen, the indicator at the right of the Realtime Control knobs will go out, and the Realtime Control knobs can be used to edit the MFX parameters. If you once again press the button located at the right of the Realtime Control knobs so the indicator is lit, the knobs will control their original functions. When you exit the MFX 1–3 screen, the indicator will automatically return to its previous lit state.

MEMO

Parameters marked by can be selected as a multi-effect control destination parameter (p. 214).

MEMO

In Patch mode, the Keyboard part can use MFX1 and the Pad part can use MFX2.

Making Multi-Effects Settings (MFX Control)

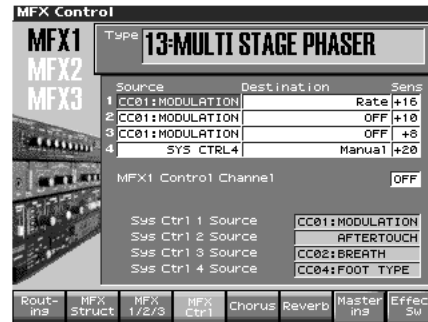

cf.

For details on these settings, refer to “Making Effect Settings” (p. 206)

Source 1–4 (Multi-Effects Control Source 1–4)

Sets the MIDI message used to change the multi-effects parameter with the multi-effects control.

Value

OFF: Multi-effects control will not be used.

CC01–31, 33–95: Controller numbers 1–31, 33–95

cf.

For more information about Control Change messages, please refer to “MIDI Implementation” (p. 298).

PITCH BEND: Pitch Bend

AFTERTOUCH: Aftertouch

SYS CTRL1–SYS CTRL4: MIDI messages used as common multi-effects controls.

TIP

If you want to use common controllers for the entire Fantom-X, select “SYS CTRL 1”–“SYS CTRL 4.” MIDI messages used as System Control 1–4 are set with the Sys Ctrl 1–4 Source parameters (p. 233).

NOTE

In patch/rhythm set mode, there are parameters that determine, for each tone/rhythm tone, whether or not Pitch Bend, Controller Number 11 (Expression) and Controller Number 64 (Hold 1) are received (p. 79). When these settings are “ON,” and the MIDI messages are received, then when any change is made in the settings of the desired parameter, the Pitch Bend, Expression, and Hold1 settings also change simultaneously. If you want to change the targeted parameters only, then set these to “OFF.”

- There are parameters that determine whether or not specific MIDI messages are received for each MIDI channel (p. 79). When using the multi-effects control, confirm that any MIDI messages used for the multi-effects control will be received. If the Fantom-X is set up such that reception of MIDI messages is disabled, then the multi-effects control will not function.

Destination 1-4 (Multi-Effects Control Destination 1-4)

Sets the multi-effects parameters to be controlled with the multi-effects control. The multi-effects parameters available for control will depend on the multi-effects type. For details, refer to “**Multi-Effects Parameter**” (p. 270).

Sens 1-4 (Multi-Effects Control Sensitivity 1-4)

Sets the amount of the multi-effects control’s effect that is applied. To make an increase in the currently selected value (to get higher values, move to the right, increase rates, and so on), select a positive value; to make a decrease in the currently selected value (to get lower values, move to the left, decrease rates, and so on), select a negative value. For either positive or negative settings, greater absolute values will allow greater amounts of change. Set this to “0” if you don’t want to apply the effect.

Value: -63–+63

MFx Control Channel (Multi-Effects Control Channel)

This determines the channel that will be used for reception when using the Multi-effects Control to modify multi-effects parameters in real time, when the MFx1-3 Source parameter (p. 212) is set to “PRF.” Set this to “OFF” when the Multi-effects Control is not being used.

Value: 1-16, OFF

* This parameter is not found in Patch mode.

Multi-Effects Control

If you wanted to change the volume of multi-effects sounds, the delay time of Delay, and the like, using an external MIDI device, you would need to send System Exclusive messages-MIDI messages designed exclusively for the Fantom-X. However, System Exclusive messages tend to be complicated, and the amount of data that needs to be transmitted can get quite large. For that reason, a number of the more typical of the Fantom-X’s multi-effects parameters have been designed so they accept the use of Control Change (or other) MIDI messages for the purpose of making changes in their values. For example, you can use the Pitch Bend lever to change the amount of distortion, or use the keyboard’s touch to change the delay time of Delay. The parameters that can be changed are predetermined for each type of multi-effect; among the parameters described in “**Multi-Effects Parameter**” (p. 270), these are indicated by a “#.”

In the multi-effect setting screen, a “c” symbol will be shown at the left of the parameter.

The function that allows you use MIDI messages to make these changes in realtime to the multi-effects parameters is called the **Multi-effects Control**. Up to four multi-effects controls can be used in a single patch/rhythm set/performance.

When the multi-effects control is used, you can select the amount of control (Sens parameter) applied, the parameter selected (Destination parameter), and the MIDI message used (Source parameter).

TIP

By using the Matrix Control instead of the Multi-effects Control, you can also change the parameters of some popular multi-effects in realtime (p. 80).

Specifying the multi-effect structure (MFX Structure)

Here's how to specify how MFX 1–3 will be connected.

* This parameter is not found in Patch mode.

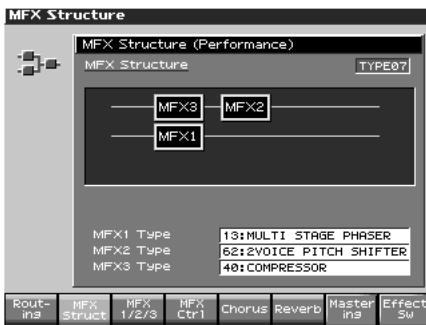

cf.

For details on these settings, refer to “Making Effect Settings” (p. 206)

Structure Type

Specify how MFX1–3 will be connected.

Value: Type 01–Type 16

MFX1–3 TYPE

Selects the multi-effect type of MFX1–3.

Value: 0 (Through)–78

Making Chorus Settings (Chorus)

Here we will explain how to make chorus settings in Performance mode. The procedure is the same when making settings in Patch mode.



cf.

For details on these settings, refer to “Making Effect Settings” (p. 206)

Type (Chorus Type)

Selects either chorus or delay.

Value

0 OFF: Neither chorus or delay is used.

1 CHORUS: Chorus is used.

2 DELAY: Delay is used.

3 GM2 CHORUS: General MIDI 2 chorus

* In this setting screen, you can edit the parameters of the chorus/delay that is selected by the Chorus Type setting. For details on the parameters that can be edited, refer to “Chorus Parameters” (p. 293).

TIP

If a number (**1**–**78**) is shown for a parameter in the screen, you can use the corresponding Realtime Control knob (far left knob is **1**–far right knob is **78**) to adjust the value of that parameter. When you enter the Chorus screen, the indicator at the right of the Realtime Control knobs will go out, and the Realtime Control knobs can be used to edit the Chorus parameters. If you once again press the button located at the right of the Realtime Control knobs so the indicator is lit, the knobs will control their original functions. When you exit the Chorus screen, the indicator will automatically return to its previous lit state.

Making Reverb Settings (Reverb)

Here we will explain how to make reverb settings in Performance mode. The procedure is the same when making settings in Patch mode.

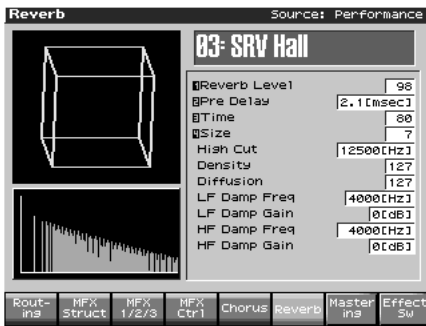

cf.

For details on these settings, refer to “**Making Effect Settings**” (p. 206)

Type (Reverb Type)

Selects the type of Reverb.

Value

- 0 OFF:** Reverb is not used.
- 1 REVERB:** Normal Reverb
- 2 SRV ROOM:** This reverb simulates typical room acoustic reflections.
- 3 SRV HALL:** This reverb simulates typical concert hall acoustic reflections.
- 4 SRV PLATE:** This reverb simulates a reverb plate, a popular type of artificial reverb unit that derives its sound from the vibration of a metallic plate. You can also achieve unusual metallic-sounding reverbs using “SRV PLATE.”
- 5 GM2 REVERB:** General MIDI 2 reverb

* In this setting screen, you can edit the parameters of the reverb that is selected by the Reverb Type setting. For details on the parameters that can be edited, refer to “**Reverb Parameters**” (p. 294).

TIP

If a number (**1** - **4**) is shown for a parameter in the screen, you can use the corresponding Realtime Control knob (far left knob is **1** - far right knob is **4**) to adjust the value of that parameter. When you enter the Reverb screen, the indicator at the right of the Realtime Control knobs will go out, and the Realtime Control knobs can be used to edit the Reverb parameters. If you once again press the button located at the right of the Realtime Control knobs so the indicator is lit, the knobs will control their original functions. When you exit the Reverb screen, the indicator will automatically return to its previous lit state.

Mastering Effect

This is a stereo compressor (limiter) that is applied to the final output of the Fantom-X. It has independent high, mid, and low ranges. Independently for the high-frequency, mid-frequency, and low-frequency regions, this compresses any sounds that exceed the specified level, making the volume more consistent. When mixing down to MD, or DAT, or when you procedure your own original audio CD, this lets you master at an optimized level.

- * Mastering effect settings apply to the entire Fantom-X. These settings are not for individual patches or performances.
- * The mastering effect is applied to the sound that is output from the OUTPUT A (MIX) jacks. It will not be applied to the sound that is output from the OUTPUT B jacks.



cf. ➔

For details on these settings, refer to “Making Effect Settings” (p. 206)

Function Buttons	Explanation
[F1]–[F5]	Recall preset settings for each type.
[F6 (User)]	Recall saved user settings.
[F7 (System Write)]	Save the current settings as user settings. Only one set of user settings can be saved.
[F8 (Effect Sw)]	You can press this to open the Effect Sw window and turn each effect on/off. Turn [F6 (Mastering Sw)] on/off to hear the result of the mastering effect.

ATTACK

Time from when the volume goes up the threshold level until the compressor effect applies

Value: 0-100 ms

RELEASE

Time from when the volume falls below the threshold level until the compressor effect no longer applies

Value: 50-5000 ms

THRESHOLD

Volume level at which compression begins

Value: -36-0 dB

RATIO

Compression ratio

Value: 1.00:1-INF:1 (INF: infinity)

LEVEL

Output volume

Value: 0-24 dB

Split Frequency High

Frequency at which the high-frequency (HI) and mid-frequency (MID) bands are split

Value: 2000-8000 Hz

Split Frequency Low

Frequency at which the low-frequency (LO) and mid-frequency (MID) bands are split

Value: 200-800 Hz

About THRESHOLD and RATIO

As shown in the diagram below, these parameters determine how the volume is to be compressed.

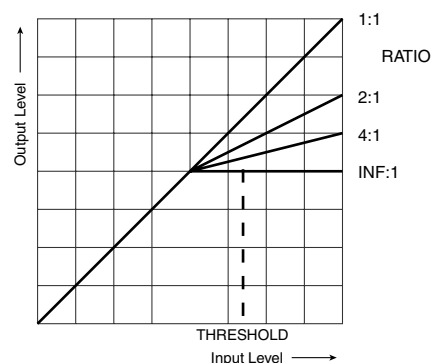

Connecting to Your Computer via USB (USB Mode)

About USB Functions

The Fantom-X has two modes of USB functionality: storage mode for transferring files, and MIDI mode for sending and receiving MIDI messages. You must switch between these two modes on the Fantom-X; they cannot be used simultaneously.

NOTE

The USB mode (file transfer/MIDI communication) must be switched before you connect the Fantom-X with your computer.

Each mode can be used with the following operating systems.

Operating System	Storage Mode	MIDI Mode
Windows XP/2000/Me or later	√	√
Windows 98/98SE	not supported	√
Mac OS 9 (9.04 or later)	√	√
Mac OS X	√	√

* This may not work correctly with some types of computer.

Switching the Storage Mode and the MIDI Mode

Selecting USB Storage Mode

NOTE

You must switch the Fantom-X to USB Storage mode before you connect the Fantom-X and your computer with a USB cable.

1. Press [MENU].
2. Press ▲ or ▼ to select "System," and then press [ENTER].
3. Press [F1 (↑)] or [F2 (↓)] to select "USB."
The USB screen will appear.
4. Press ▲ or ▼ to select "USB Mode."
5. Turn the VALUE dial or use [INC] [DEC] to select "STORAGE."
A confirmation dialog box will appear.
6. To switch the USB mode, press [F8 (OK)]. If you decide not to switch, press [F7 (Cancel)].
USB Storage mode will be selected.
7. If you want the Fantom-X to start up in USB Storage mode the next time it is powered up, press [F8 (System Write)] to save the System settings.

cf.

For details on operations in USB Storage mode, refer to "Transferring Files to or from Your Computer (Storage Mode)" (p. 219).

Selecting MIDI Mode

NOTE

You must switch the Fantom-X to MIDI mode before you connect the Fantom-X and your computer with a USB cable.

NOTE

If you've selected USB MIDI mode, nothing can be received from the MIDI IN connector.

1. Press [MENU].
2. Press ▲ or ▼ to select "System," and then press [ENTER].
3. Press [F1 (↑)] or [F2 (↓)] to select "USB."
The USB screen will appear.
4. Press ▲ or ▼ to select "USB Mode."
5. Turn the VALUE dial or use [INC] [DEC] to select "MIDI."
A confirmation dialog box will appear.
6. To switch the USB mode, press [F8 (OK)]. If you decide not to switch, press [F7 (Cancel)].
MIDI mode will be selected.
7. Press ▲ or ▼ to select "USB MIDI-Thru."
8. Turn the VALUE dial or use [INC] [DEC] to make settings for USB-MIDI Thru Switch.
This switch specifies whether MIDI messages received at the USB connector or the MIDI IN connector will be retransmitted from the USB connector or the MIDI OUT connector (ON) or not (OFF).
9. If you want the Fantom-X to start up in MIDI mode the next time it is powered up, press [F8 (System Write)] to save the System settings.

cf.

For details on operations in MIDI mode, refer to "Exchanging MIDI Messages with Your Computer (MIDI Mode)" (p. 222).

Transferring Files to or from Your Computer (Storage Mode)

By connecting the Fantom-X with your computer via a USB cable, you can transfer files from Internal user area or a memory card to and from the hard disk or other media of your computer, in order to back up your data.

You can use software on your computer to edit wave data you've created on the Fantom-X. Conversely, wave data that you've created on your computer can be used on the Fantom-X.

In this way, USB Storage mode lets you transfer files such as patch and waves to or from a connected computer.

NOTE

Connect or disconnect the USB cable only when the Fantom-X is powered-off. Never connect or disconnect the USB cable or turn off the power while in USB mode or while data is being transferred.

Connections

1. With the Fantom-X not connected, start up your computer.
2. Use a USB cable to connect the Fantom-X to your computer.
3. Turn on the power (POWER switch) of the Fantom-X.

Specify the Connection-Destination

When the Fantom-X is connected to your computer, you can select the area on the Fantom-X to which a connection is to be made; either the internal user area or the memory card.

1. Press [MENU].
2. Press ▲ or ▼ to select "USB," and then press [ENTER]. The USB screen will appear.

* If USB is not set to Storage mode, a warning of "The USB is in MIDI Mode!!" will appear when you press [ENTER] in step 2. Press [F8 (Exec)] if you want to switch to USB Storage mode (the USB settings screen will appear). If you decide to cancel, press [F7 (Cancel)].



3. Press [F3 (Internal)] or [F6 (Memory Card)] to connect with your computer.

[F3 (Internal)]: Connect to the user memory

[F6 (Memory Card)]: Connect to the memory card

* To cancel the connection, press [Exit].

4. The display will differ as follows, depending on the computer you're using.

- **Windows Me/2000 users**

A drive named "Removable disk" will be displayed within My Computer.

Below that drive there will be folders named "ROLAND" and "TMP."

- **Windows XP users**

A drive named "FANX USER" will be displayed within My Computer. If a memory card is connected, its volume name will be displayed.

Below that drive there will be folders named "ROLAND" and "TMP."

- **Macintosh users**

A drive icon named "FANX USER" will appear on the desktop.

If a memory card is connected, its volume name will be displayed.

Below it will be folders named "ROLAND" and "TMP."

Connecting to Your Computer via USB (USB Mode)

Cautions Regarding Folders and Files

You must observe the following points when the Fantom-X is connected to your computer via USB.

- Don't use your computer to move or delete folders within the Fantom-X.
- Don't use your computer to format or optimize the Fantom-X's user memory or memory card, or execute operations such as Scan Disk.
- The Fantom-X can only handle filenames consisting of single-byte alphanumeric characters.
- Only the following types of files can be transferred between the Fantom-X and your computer.
Song files (.SVQ) (MRC PRO songs)
Standard MIDI Files
Audio files (.WAV/AIFF)
Bitmap files (.BMP) (320 x 240 pixels)
Text file (.TXT)
- To handle these files, use the appropriate method described below.

Song files, Standard MIDI Files	Place the files in the following folder. ROLAND/SEQ/SNG
Audio files	When placing the files from your computer, place them in the following location. TMP/AUDIO_IMPORT folder Then import the audio files. If you want to use your computer to read samples that were written by the Fantom-X, load the files from the ROLAND/SMPL folder into your computer.
BMP files	When placing the files from your computer, place them in the following location. TMP/BMP folder
Text files	When placing the files from your computer, place them in the following location. TMP/TEXT folder Then import the text file.

- Do not use your USB-connected computer to delete or rewrite any files placed in the ROLAND/SND folder.

Exiting Storage Mode

Windows Me/2000/XP Users

1. In My Computer, right-click the "removable hard disk" icon and execute "Remove."

Macintosh Users

1. Drag the Fantom-X drive icon into the trash.

Canceling USB Communication

If you want to power off the Fantom-X when it is connected to your computer in Storage mode, you must first cancel USB communication on your computer as described here.

Windows Me/2000/XP Users

1. Use the device eject button shown in the taskbar at the lower right of your computer screen to cancel the connection with the Fantom-X.

Macintosh Users

1. Make sure that the Fantom-X drive icon is not on your desktop.

Examples of Using Storage Mode

Importing Audio file (Import Audio)

Here's how to import an audio file (WAV/AIFF).

In order to import a file, it must be located in the following folder found on your computer.

- **Windows Me/2000 users**
Removable disk/TMP/AUDIO_IMPORT folder
- **Macintosh, Windows XP users**
FANS USER/TMP/AUDIO_IMPORT folder

* "/" indicates a directory level.

1. Press [Save/Load].
2. Press [F8 (Import Audio)].
3. Press [F1 (User)] or [F2 (Card)] to select the import-destination area.
[F1 (User)]: Import from user memory.
[F2 (CARD)]: Import from a memory card.
4. Press ▲ or ▼, then select the file that you want to import.
If you want to select two or more samples, press [F5 (Mark Set)] to add a check mark (✓) to the files that you want to select. To remove the check mark, press [F4 (Mark Clear)].
If you hold down [SHIFT] and press [F5 (Mark Set All)], a check mark will be added to all files of the selected bank. If you hold down [SHIFT] and press [F4 (Mark Clr All)], check marks will be removed from all selected files.
5. Press [F8 (Import Audio)].
A message will ask you for confirmation.
* To cancel, press [F7 (Cancel)].
6. Press [F8 (Exec)].
The file will be imported, and the Sample List screen will appear.
* To cancel, press [F7 (Cancel)].

MEMO

The imported file will be added to the sample list as a sample. This sample is temporary, and will be lost when you turn off the power. If you want to keep it, press [WRITE] to save the data (p. 159).

Using a Bitmap File as a Background in the Display

For example, you can import a favorite bitmap file into the Fantom-X, and use it as a background in the display screen.

* *The only files that can be transferred between the Fantom-X and your computer are **bitmaps (320 x 240 pixels)**.*

In order to import a file, it must be located in the following folder on your computer.

- **Windows Me/2000 users**
Removable disk/TMP/BMP folder
 - **Macintosh, Windows XP users**
FANS USER/TMP/BMP folder
- * *"/" indicates a directory level.*

Importing a Bitmap File (Import BMP)

Here's how to import a copied file and use it as the background in the Fantom-X's display.

1. Press [MENU].
2. Press ▲ or ▼ to select "System," and then press [ENTER].
3. Press [F1 (⏴)] or [F2 (⏵)] to select "Background."



The Fantom-X has 16 pictures that can be displayed for the background. When you import a file, it replaces the currently selected picture.

4. Press [F7 (Import BMP)].
5. Press [F1 (User)] or [F2 (Card)] to select the import-destination area (user memory or card).
6. Press ▲ or ▼, then select the file that you want to import.
7. Press [F8 (Import BMP)].
The file you want to import will be displayed.
* *To cancel, press [F7 (Cancel)].*
8. Press [F8 (Exec)].
The file will be imported.
* *To cancel, press [F7 (Cancel)].*
9. Press [EXIT].

Displaying text memos in the Live Setting screen (Import Text)

You can create a text file on your computer and display it in the Live Setting screen (p. 42). Since this lets you add a note to each bank, it's a convenient way to provide reminders, such as an explanation of each screen.

1. **Create a text file on your computer, and save it with a filename extension of ".TXT".**
2. **Place the text file you created in step 1 in the following location of the Fantom-X.**
 - Windows Me/2000/XP users
Removable Disk/ROLAND/SNG folder
 - Macintosh users
FANX USER/ROLAND/SNG folder

* *"/" indicates the levels of the directory structure.*
3. **Execute Importing TEXT.**
For details on how to import, refer to "Importing a Text File (Import Text)" (p. 43).

Connecting to Your Computer via USB (USB Mode)

Exchanging MIDI Messages with Your Computer (MIDI Mode)

Driver Installation and Settings

In order to use the Fantom-X as a USB MIDI device from your computer, you must first install the USB MIDI driver. The USB MIDI driver is on the included "Fantom-X Driver CD-ROM."

In order to use USB in MIDI mode, you must install the driver from the included CD-ROM into your computer.

The correct driver and the installation procedure will depend on your system and on the other programs you are using. Be sure to read the Readme file on the CD-ROM before installation.

Windows XP/2000

\Win2kXP\Readme_e.htm

Windows Me/98/98SE

\Win98Me\Readme_e.htm

Mac OS 9 (9.04 or later)

\Fantom-X Driver OS9 (E)\Readme_e.htm

Mac OS X

\Fantom-X Driver OSX (E)\Readme_e.htm



Caution when disconnecting the USB cable

You must shut down your computer before disconnecting the USB cable. Disconnecting the cable while your computer's power is on may destabilize its operation.

What is the USB MIDI Driver?

The USB MIDI Driver is a software which passes data between the Fantom-X and the application (sequencer software, etc.) that is running on the USB-connected computer.

The USB MIDI Driver sends data from the application to the Fantom-X, and passes data from the Fantom-X to the application.

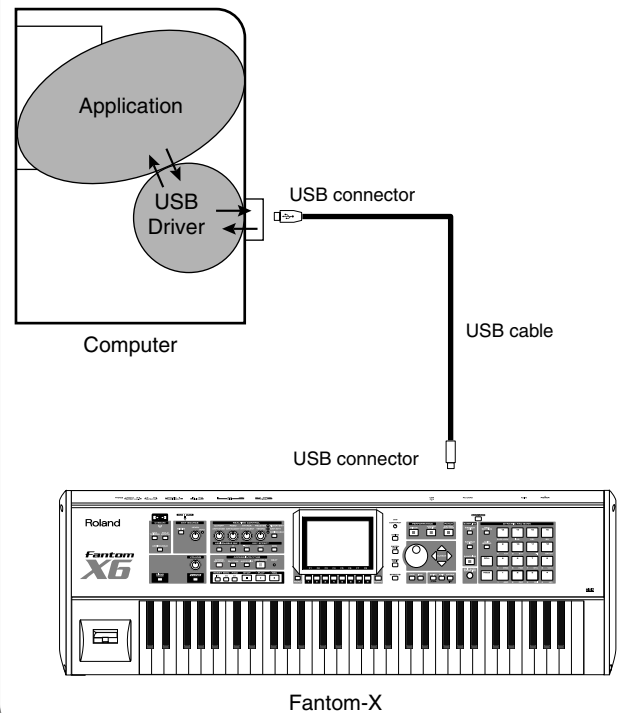

File-Related Functions (File Utility)

Here you can perform a variety of operations related to the files stored in the Fantom-X's user memory, and on memory cards. You can copy, delete, or move files, as well as format memory cards. The folder structure of the user area and memory card is as follows.

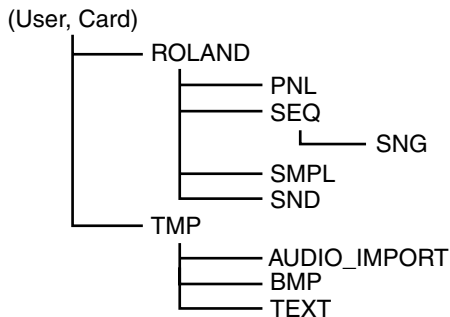

NOTE

You must observe the following points when managing files with the Fantom-X connected to your computer via USB.

- Don't use your computer to move or delete folders within the Fantom-X.
- Don't use your computer to format or optimize the Fantom-X's user memory or memory card, or execute operations such as Scan Disk.
- The Fantom-X can only handle filenames consisting of single-byte alphanumeric characters.
- Don't use your computer to delete or overwrite the files located in the ROLAND/SND folder.

When copying files from your computer into the Fantom-X's user area or memory card, place them in the following folders.

Computer	Fantom-X
SONG file (.SVQ) (MRC PRO song)	ROLAND/SEQ/SNG
Standard MIDI file (SMF format 0, 1)	ROLAND/SEQ/SNG
Audio file (WAV/AIFF)	TMP/AUDIO_IMPORT folder
Bitmap file (320 x 240 pixels)	TMP/BMP
Text file (.TXT)	TMP/TEXT

Don't place files of any other format in the user memory or memory card.

Basic Procedure

1. Press [MENU].
2. Press ▲ or ▼ to select "File Utility," and then press [ENTER].

The File Utility screen will appear.



3. Press the function buttons to select the operation you want to carry out.

- [F1 (User)]: Select a file in user memory.
- [F2 (Card)]: Select a file on the memory card.
- [F3 (Card Format)]: Format (initialize) a memory card.
- [F4 (Mark Clear)]: Remove check marks from the files. If you hold down [SHIFT] and press [F4 (Mark Clr All)], check marks will be removed from all files.
- [F5 (Mark Set)]: If you want to select two or more files, add a check mark (✓) to the files. If you hold down [SHIFT] and press [F5 (Mark Set All)], check marks will be added to all files.
- [F6 (Delete)]: Delete a selected file or files with check marks.
- [F7 (Move)]: Move a file or files with check marks to a different folder.
- [F8 (Copy)]: Copy a file or files with check marks to a different folder.
- ▲, ▼: Select the folder.
- ◀, ▶: Move between folder levels.

Copying a File (Copy)

Here's how you can copy a file to a different folder.

1. **As described in the basic procedure, select the file that you want to copy.**

[F1 (User)] [F2 (Card)]: Select the memory
▲, ▼: Select the folder
◀, ▶: Move between folder levels

2. **Press [F8 (Copy)].**

A screen will appear, allowing you to select the folder to which the file is to be copied.

3. **View the contents of the copy-destination folder.**

[F1 (User)] [F2 (Card)]: Select the memory
▲, ▼: Select the folder
◀, ▶: Move between folder levels

4. **To copy the file, press [F8 (Exec)].**

* To cancel, press [F7 (Cancel)].

Deleting a File (Delete)

Here's how you can delete an unwanted file from a folder.

1. **As described in the basic procedure, select the file that you want to delete.**

[F1 (User)] [F2 (Card)]: Select the memory
▲, ▼: Select the folder
◀, ▶: Move between folder levels

2. **Press [F6 (Delete)].**

A message will ask you for confirmation.

3. **To delete the file, press [F8 (Exec)].**

* To cancel, press [F7 (Cancel)].

Moving a File (Move)

Here's how you can move a file to a different folder.

1. **As described in the basic procedure, select the file that you want to move.**

[F1 (User)] [F2 (Card)]: Select the memory
▲, ▼: Select the folder
◀, ▶: Move between folder levels

2. **Press [F7 (Move)].**

A screen will appear, allowing you to select the folder to which the file is to be moved.

3. **View the contents of the move-destination folder.**

[F1 (User)] [F2 (Card)]: Select the copy destination
▲, ▼: Select the folder
◀, ▶: Move between folder levels

4. **To move the file, press [F8 (Exec)].**

* To cancel, press [F7 (Cancel)].

Initializing a Memory Card (Card Format)

Here's how to initialize a memory card. When you execute the Format operation, the contents of the memory card will be completely erased.

1. **From the file Utility screen, press [F3 (Card Format)].**

A message will ask you for confirmation.

2. **To format the card, press [F8 (Exec)].**

* To cancel, press [F7 (Cancel)].

Settings Common to All Modes (System Function)

Settings that affect the entire operating environment of the Fantom-X, such as tuning and MIDI message reception, are referred to as **system functions**. This section explains how to make settings for the System functions and describes the functions of the different System parameters.

How to Make System Function Settings

1. Press [MENU] to open the Menu window.
2. Press ▲ or ▼ to select “System,” and then press [ENTER].

The System Setup screen appears.



3. Press Function button [F3], [F4] to select the tab of the edit group.
 - [F3 (Setup)]
Set system parameters (p. 226).
 - [F4 (Info)]
View system information (p. 234).
4. The parameters are organized into several edit groups. Use [F1 (↑)][F2 (↓)] to switch tabs.
5. Use [CURSOR] to move the cursor to the parameter you wish to modify.

MEMO

When the cursor is located at a parameter value, you can press [ENTER] to access a window for setting the value.

- When all the parameters cannot be shown within a single settings screen, a scroll bar will be displayed at the right side of the screen. In such cases, press ▼ to scroll the screen downward.
6. Turn the VALUE dial or press [INC]/[DEC] to get the value you want.
 7. Repeat steps 4–6 to set each System parameter you want to edit.
 8. To save the settings you modified, press [F8 (System Write)] and perform the Write operation. If you do not want to save, press [EXIT] to return to the previous screen.

Saving the System Settings (System Write)

Changes you make to the System function settings are only temporary—they will be discarded as soon as the power is turned off. If you want to keep any changes you’ve made in the system settings, you must save them in internal system memory.

NOTE

When you perform the save procedure, the data that previously occupied the save destination will be lost. However, the factory setting data can be recovered by performing the Factory Reset procedure.

1. Change the system function settings, and press [F8 (System Write)].



The display will indicate “System Write Completed!” The data will be saved, and you’re returned to the System Setup screen.

Functions of System Parameters

This section explains what the different System parameters do, and also how these parameters are organized.

cf. →

For details on these settings, refer to “**How to Make System Function Settings**” (p. 225).

Pedal/D Beam

D Beam Sens (D Beam Sensitivity)

This sets the D Beam controller’s sensitivity. Increasing this value will raise the sensitivity.

Value: 0–127

Control Pedal Assign

This specifies the function of each pedal connected to the PEDAL CONTROL jacks.

Value

CC01–31, 33–95: Controller numbers 1–31, 33–95

cf. →

For details on control change messages, refer to “**MIDI Implementation**” (p. 298).

- BEND UP:** The pitch will rise in semitone steps (maximum 4 octaves) each time you press the pedal.
- BEND DOWN:** The pitch will fall in semitone steps (maximum 4 octaves) each time you press the pedal.
- AFTERTOUCHE:** Aftertouch
- OCT UP:** Each pedal press raises the key range in octave steps (up to 3 octaves higher).
- OCT DOWN:** Each pedal press lowers the key range in octave steps (up to 3 octaves lower).
- START/STOP:** The sequencer will start/stop.
- PUNCH IN/OUT:** Manual punch-in/out recording will start/stop.
- TAP TEMPO:** Tap tempo (a tempo specified by the interval at which you press the pedal).
- PROG UP:** The next sound number will be selected.
- PROG DOWN:** The previous sound number will be selected.
- FAVORITE UP:** The favorite patch/performance of the next number or bank will be selected.
- FAVORITE DOWN:** The favorite patch/performance of the previous number or bank will be selected.
- ARP SW:** Switches the Arpeggio/Rhythm function on/off.
- RHY START/STOP:** Switch Rhythm pattern playback on/off.
- CHORD SW:** Chord function on/off.
- LIVE SET UP:** Switches to the next step within a Live Setting list.

LIVE SET DOWN: Switches to the previous step within a Live Setting list.

LOOP: Loop play On/Off

Control Pedal Polarity

Selects the polarity of the pedal. On some pedals, the electrical signal output by the pedal when it is pressed or released is the opposite of other pedals. If your pedal has an effect opposite of what you expect, set this parameter to “REVERSE.” If you are using a Roland pedal (that has no polarity switch), set this parameter to “STANDARD.”

Value: STANDARD, REVERSE

Hold Pedal Polarity

Select the polarity of the Hold pedal. On some pedals, the electrical signal output by the pedal when it is pressed or released is the opposite of other pedals. If your pedal has an effect opposite of what you expect, set this parameter to “REVERSE.” If you are using a Roland pedal (that has no polarity switch), set this parameter to “STANDARD.”

Range: STANDARD, REVERSE

Continuous Hold Pedal

This setting determines whether the HOLD PEDAL jack will provide support for half-pedaling (ON), or not (OFF). When this is set to support use of half-pedaling techniques, you can then connect an optional expression pedal (DP-8, etc.), and employ pedal work to achieve even finer control in performances in which piano tones are used.

Value: OFF, ON

Keyboard

Keyboard Velocity

Specifies the velocity value that will be transmitted when you play the keyboard. If you want actual keyboard velocity to be transmitted, set this to “REAL.” If you want a fixed velocity value to be transmitted regardless of how you play, specify the desired value (1–127).

Value: REAL, 1–127

Keyboard Sens (Keyboard Sensitivity)

Adjusts the keyboard’s touch.

Value

LIGHT: Light weight synthesizer keyboard like

MEDIUM: Standard

HEAVY: Acoustic piano simulation

Aftertouch Sens (Aftertouch Sensitivity)

Specifies the Aftertouch sensitivity. Higher values will allow Aftertouch to be applied more easily. Normally you will leave this at “100.”

Value: 0–100%

Sync/Temp

Sync Mode

Specify the synchronization message that the Fantom-X's sequencer will use for operation.

Value

- MASTER:** The Fantom-X will be the master. Choose this setting when using the Fantom-X by itself without synchronizing to another device, or when you want other MIDI devices to synchronize to the Fantom-X.
- SLAVE-MIDI:** The Fantom-X will be the slave. Choose this setting when you want the Fantom-X to synchronize to MIDI Clock messages received from another MIDI device.
- SLAVE-MTC:** The Fantom-X will be the slave. Choose this setting when you want the Fantom-X to synchronize to MTC (MIDI Time Code) received from an external device.
- REMOTE:** Use this setting when you wish an external MIDI device to have remote start/stop control. The tempo will be in accord with what has been set on the Fantom-X.

MIDI Clock and MTC

MIDI Clock and MTC (MIDI Time Code) are both messages used for synchronization. Select either of them depending on the application.

MIDI Clock transmits and synchronizes operations to a sequencer's performance tempo, whereas MTC synchronizes operations between devices based on an absolute time. Since Roland VS Series workstations are hard disk recorders, they cannot send MIDI Clock. Therefore, using a MTC is convenient for synchronization of the hard disk recorder and the Fantom-X. However, VS Series devices also feature specialized tracks for recording MIDI Clock, so with the Fantom-X's MIDI Clock recorded in this manner, we have another synchronizing technique in which the VS device appears to be sending MIDI Clock (although it is actually playing back tracks to which MIDI Clock has been recorded). However, since the tempo must be recorded to the VS sync track beforehand, MTC is only convenient in synchronizing with songs that do not contain great amounts of tempo data.

Sync Output (Sync Output Switch)

Set this parameter ON when you want synchronization related MIDI messages (MIDI Clock, Start, Continue, Stop, Song Position Pointer and Song Select) to be transmitted to an external MIDI device. If not, set it OFF.

Value: OFF, ON

Tempo Override

Specify whether the sequencer tempo will change (ON), or will not change (OFF) when you switch performance.

Value: ON, OFF

Arpeggio/Rhythm Sync Switch

Specifies whether the arpeggio or rhythm pattern will start/stop in synchronization with the sequencer. This parameter does nothing if the sequencer is stopped.

Value

- OFF:** Start/stop will not synchronize to the synthesizer.
- ON:** While the sequencer is running, the arpeggio will start at the beginning of the next measure. When you stop the sequencer, the arpeggios will also stop.

MMC Mode

When synchronizing the Fantom-X with a hard disk recorder, such as one from the Roland VS series, specify which synchronization signal the Fantom-X's sequencer will use for operation.

Value

- MASTER:** The Fantom-X will be the master. Use this setting when you want other devices to follow the operation of the Fantom-X.
- SLAVE:** The Fantom-X will be the slave. Use this setting when you want the Fantom-X to receive MMC (MIDI Machine Control) from an external device and operate accordingly.

MEMO

MMC (MIDI Machine Control) is a specification that allows MIDI messages to be used to control devices such as tape recorders, VTR's, and digital recording systems. Thirty-seven MMC commands are available, including Stop and Play.

MMC Output (MMC Output Switch)

Turn this "ON" if you want to synchronize with a hard disk recorder, such as one from the Roland VS series. When set "ON," MMC (MIDI Machine Control) related commands (Play, Stop and Locate) will be transmitted.

Value: OFF, ON

MTC Sync Output (MTC Sync Output Switch)

Set this parameter ON when you want MTC (MIDI Time Code) to be transmitted to an external MIDI device. If not, set it OFF.

Value: OFF, ON

MTC Frame Rate

Specify the MTC frame rate. Make sure that the same mode is set in both master and slave devices.

Value

- 24:** 24 frames per second
- 25:** 25 frames per second
- 29N:** 29 frames per second
- 29D:** 29 frames per second
- 30:** 30 frames per second

TIP

When synchronizing with a hard disk recorder such as the Roland VS series, any frame rate is all right—as long as the setting matches that of the Fantom-X. However, when synchronizing operation with video devices such as video decks, the video device's frame rate is fixed, so the Fantom-X's setting must correspond to that frame rate.

Settings Common to All Modes (System Function)

Types of MTC

The types of MTC that can be selected by the Fantom-X are shown below. Select the same frame rate as that set for the external device. When not using a video device, then any frame rate may be selected as long as the rates are the same on both devices being synchronized.

- 30:** This is 30 frames per second, non-drop format. This is used by audio devices such as analog tape recorders, and for NTSC format black and white video (used in Japan and the U.S.).
- 29N:** This is 29.97 frames per second, non-drop format. This is used for NTSC format color video (used in Japan and the U.S.).
- 29D:** 29.97 frames per second drop format. This is used for NTSC format color video (used in Japan and the U.S.).
- 25:** 25 frame per second frame rate. This is used for SECAM or PAL format video, audio equipment, and film (used in Europe and elsewhere).
- 24:** 24 frame per second frame rate. This is used for video, audio devices, and film in the US.

Non-Drop Format and Drop Format

There are two types of format used by NTSC video cassette recorders, non-drop and drop. Non-drop format features continuous time code, whereas in drop format, which is used for NTSC color video format, the first two frames of every minute are dropped, except for those at ten-minute intervals. In most video and audio production, since formats with continuous frames are easier to deal with, non-drop is generally used. In contrast, in situations such as in broadcast, where the time code must match actual clock time, drop is used.

MTC Offset Time Hour

Coordinates the playback timing of the Fantom-X and the external device in an hour units.

Value: 00–23 hours

MTC Offset Time Minute

Coordinates the playback timing of the Fantom-X and the external device in a minute units.

Value: 00–59 minutes

MTC Offset Time Second

Coordinates the playback timing of the Fantom-X and the external device in a second units.

Value: 00–59 seconds

MTC Offset Time Frame

Coordinates the playback timing of the Fantom-X and the external device in a frame units.

Value: 00–29 frames

MTC Error Level

Determines how often the reception status is checked when MTC is being received from an external device. Stop synchronization if a problem becomes apparent with the check.

Value: 0–10 (the checking interval will be longer for larger values)

NOTE

In strict terms, the lower the numerical value set, the more accurate the check is. However, playback may be stopped overly frequently if too rigorous a check is made, and this soon becomes inconvenient. By raising the Error Level setting, then even if problems with the reception of MTC do occur, synchronization can then continue as long as such problems remain at a level that does not cause undue problems.

Metronome

Metronome Mode

Specifies when you want the metronome to sound.

- * If [F7 (Click)] in the Tempo window which appears when you press [TEMPO] is lit in red, the metronome will always sound.

Value

- OFF:** Will not sound.
- PLAY ONLY:** Will sound only during playback.
- REC ONLY:** Metronome will sound only for recording.
- PLAY&REC:** Metronome will sound for playback and recording.
- ALWAYS:** Metronome will always sound.

Metronome Level

You can adjust the volume of the metronome.

Value: 0–10

Metronome Sound

Selects the metronome sound.

Value

- TYPE 1:** A conventional metronome sound will be heard. A bell will sound on the first beat.
- TYPE 2:** Clicks will sound.
- TYPE 3:** Beeps will sound.
- TYPE 4:** Cowbell will sound.

Beat Indicator Mode

You can specify how the beat indicator on the panel will blink.

Value

- ALWAYS** (always blinks at the specified tempo)
- PLAY&REC** (blinks only during playback and recording)

Sound

Local Switch

The Local Switch determines whether the internal sound generator is disconnected (OFF) from the controller section (keyboard, Pad, pitch bend/modulation lever, knobs, buttons, D Beam controller, pedal, and so on); or not disconnected (ON). Normally this is left “ON,” but if you wish to use the Fantom-X’s keyboard and controllers to control only external sound modules, set it to “OFF.”

Value: OFF, ON

Using the Local Switch

When you're using the Fantom-X with external sequencer software, leave the Local Switch turned off. Read the following for details.

Connecting the Fantom-X to an external sequencer

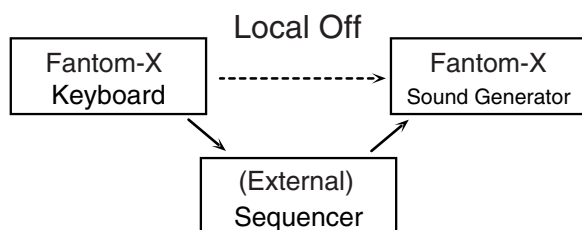

Typically, things are hooked up so the data travels as follows: the Fantom-X’s keyboard → your external sequencer software → the Fantom-X’s sound generator. Normally, the Fantom-X’s keyboard section is internally connected to its sound generator section; this internal connection is controlled by the Local Switch. If you turn the Local Switch off, the Fantom-X’s keyboard and sound generator sections will be independent, allowing you to use the connection described above with your external sequencer software.

Master Tune

Adjusts the overall tuning of the Fantom-X. The display shows the frequency of the A4 note (center A).

Value: 415.3–466.2 Hz

Master Level

Adjusts the volume of the entire Fantom-X.

Value: 0–127

How Do I Adjust the Volume?

MASTER LEVEL adjusts the volume of both the OUTPUT A jacks and the DIGITAL OUT jack. The front panel VOLUME knob adjusts only the volume of the OUTPUT A jacks. Here’s an explanation of what you need to adjust depending on the output jacks you’re using.

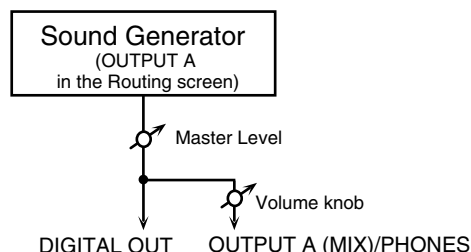

When using the OUTPUT A jacks: adjust using the VOLUME knob

The front panel VOLUME knob controls the volume of the OUTPUT A jacks. This means that if you’re outputting from the OUTPUT A jacks, the simplest way is to leave the Master Level fixed at 127 (the default setting), and use the VOLUME knob to control the volume.

When using the DIGITAL OUT jack: adjust using Master Level

Master Level controls both the OUTPUT A jacks and the DIGITAL OUT jack. This means that if you’re outputting from DIGITAL OUT, use Master Level to adjust the volume.

Adjusting the Master Level: method 1

1. In the Patch or Performance screen, hold down [SHIFT] and press [F3 (Master Level)].
The Master Level screen will appear.
2. Turn the VALUE dial or use [DEC][INC] to adjust the master level.

Adjusting the Master Level: method 2

With the factory settings, Master Level can be controlled by REALTIME CONTROL “ASSIGNABLE” knob number 1 (p. 122). This makes it easy to adjust the level using the knob.

* By changing the assignment you can use any “ASSIGNABLE” knob 1–4 to control Master Level (p. 122).

NOTE

The Master Level setting is temporary, and will be lost when you turn off the power. If you want to keep the Master Level setting you edited, save the master level in the internal system memory. → “Saving the System Settings (System Write)” (p. 225)

Settings Common to All Modes (System Function)

Output Gain

This adjusts the output gain from the Fantom-X's Analog Out and Digital Out. When, for example, there are relatively few voices being sounded, boosting the output gain can let you attain the most suitable output level for recording and other purposes.

Value: -12+12

Mix/Parallel

Specifies how the sound of the entire Fantom-X will be output.

Value

MIX: Set this to have the collective output of all sounds output from the OUTPUT A (MIX) jacks. When you want to check the final overall sound being output, set to MIX.

MEMO

Sounds which are set in the respective Output Assign to be output from the INDIVIDUAL 3 jack are output from the left OUTPUT A (MIX) jack; sounds which are set to be output from the INDIVIDUAL 4 jack are output from the right OUTPUT A (MIX) jack.

TIP

Sounds output from the PHONES jack are the same as those output from the OUTPUT A (MIX) jacks. Therefore, any sounds set with Output Assign to be output from the OUTPUT B jacks is not output from the PHONES jack. Be sure to have any sound you want to hear through the headphones set to "MIX."

PARALLEL: Output according to each Output Assign settings.

Master Key Shift

Shifts the overall pitch of the Fantom-X in semitone steps.

Value: -24+ 24

Patch Remain (Patch Remain Switch)

Specifies whether currently sounding notes will continue sounding when another patch or rhythm set is selected (ON), or not (OFF).

Also, when this is "ON," changes produced by incoming MIDI messages such as Volume or Pan (CC 5, 7, 10, 65, 68, 71-74, RPN 0, 1, 2, MONO ON, POLY ON), as well as tonal quality and volume changes produced by the various controllers will be inherited.

Value: OFF, ON

NOTE

Effects settings change as soon as you switch to a new patch or rhythm set, without being influenced by the Patch Remain setting. Because of this, certain effects settings can cause notes that were until then sounding to no longer be heard, even though Patch Remain has been set to on.

MIDI

Device ID (Device ID Number)

When you want to transmit or receive System Exclusive messages, set this parameter to match the Device ID number of the other MIDI device.

Value: 17-32

Performance Control Channel

Performance Ctrl Ch selects the MIDI receive channel used during switching of performances when MIDI messages (Program Change/Bank Select) are sent from an external MIDI device. Set this to "OFF" if performances are not to be switched from an external MIDI device.

Value: 1-16, OFF

NOTE

If only a program change is received, and if the Performance Ctrl Ch parameter setting coincides with the MIDI receive channel of a part, priority will be given to switching the performance.

Kbd Patch Rx/Tx Ch (Keyboard Patch Receive/Transmit Channel)

Specifies the channel used to transmit and receive MIDI messages for the Keyboard part in Patch mode.

Value: 1-16

Pad Patch Rx/Tx Ch (Pad Patch Receive/Transmit Channel)

Specifies the channel used to transmit and receive MIDI messages for the Pad part in Patch mode.

Value: 1-16

Transmit Program Change (Transmit Program Change Switch)

Specifies whether Program Change messages will be transmitted (ON) or not (OFF).

Value: OFF, ON

Transmit Bank Select (Transmit Bank Select Switch)

Specifies whether Bank Select messages will be transmitted (ON) or not (OFF).

Value: OFF, ON

Transmit Active Sensing (Transmit Active Sensing Switch)

Specifies whether Active Sensing messages will be transmitted (ON) or not (OFF).

Value: OFF, ON

Transmit Edit Data (Transmit Edit Data Switch)

Specify whether changes you make in the settings of a patch, performance will be transmitted as system exclusive messages (ON), or will not be transmitted (OFF).

Value: OFF, ON

Soft Through (Soft Through Switch)

Thru function re-transmits all messages received at the MIDI IN connector to the MIDI OUT connector without modifying them in any way.

Value: OFF, ON

Remote Keyboard Sw (Remote Keyboard Switch)

Set this parameter "ON" when you want to use an external MIDI keyboard instead of the Fantom-X's keyboard. In this case, the MIDI transmit channel of the external MIDI keyboard can be set to any channel. Normally you will leave this parameter "OFF."

Value: OFF, ON

TIP

Turn this "ON" when you want to control the Fantom-X from an external MIDI device when performing with the Arpeggio or RPS function.

Receive Program Change (Receive Program Change Switch)

Specifies whether Program Change messages will be received (ON) or not (OFF).

Value: OFF, ON

Receive Bank Select (Receive Bank Select Switch)

Specifies whether Bank Select messages will be received (ON) or not (OFF).

Value: OFF, ON

Receive Exclusive (Receive System Exclusive Switch)

Specifies whether System Exclusive messages will be received (ON) or not (OFF).

Value: OFF, ON

Receive GM System On (Receive GM System On Switch)

Specifies whether General MIDI System On messages will be received (ON) or not (OFF).

Value: OFF, ON

Receive GM2 System On (Receive GM2 System On Switch)

Specifies whether General MIDI 2 System On messages will be received (ON) or not (OFF).

Value: OFF, ON

Receive GS Reset (Receive GS Reset Switch)

Specifies whether GS Reset messages will be received (ON) or not (OFF).

Value: OFF, ON

USB

USB Mode

Selects the mode in which the USB connector will be used.

Value:

Storage: Storage mode. Select this if you want to transfer files.

MIDI: MIDI mode. Select this if you want to exchange MIDI messages with a sequencer or other program.

NOTE

You must switch the USB Mode before you connect the Fantom-X to your computer via the USB cable. If you change this setting while the Fantom-X is connected, the computer may fail to recognize it correctly.

cf.

For details on connections to your computer in each USB Mode, refer to "Connections" (p. 219)

USB-MIDI Thru Sw (USB-MIDI Thru Switch)

When USB Mode is set to "MIDI," this switch specifies whether MIDI messages received at the MIDI connector will be retransmitted from the MIDI OUT connector (ON) or not (OFF).

Value: OFF, ON

Settings Common to All Modes (System Function)

Scale Tune

Scale Tune Switch

Turn this on when you wish to use a tuning scale other than equal temperament.

Value: OFF, ON

One set of Scale Tune settings can be created in Patch mode. In Performance mode, this can be set for each part of the performance (p. 111).

In Patch mode, this is valid only for the keyboard part.

The Fantom-X allows you to play the keyboard using temperaments other than equal temperament. The pitch is specified in one-cent units relative to the equal tempered pitch.

MEMO

One-cent is 1/100th of a semitone.

- The selected scale applies to MIDI messages received from an external MIDI device.

Equal Temperament

This tuning divides the octave into 12 equal parts, and is the most widely used method of temperament used in Western music. The Fantom-X employs equal temperament when the Scale Tune Switch is set to "OFF."

Just Temperament (Tonic of C)

Compared with equal temperament, the principle triads sound pure in this tuning. However, this effect is achieved only in one key, and the triads will become ambiguous if you transpose.

Arabian Scale

In this scale, E and B are a quarter note lower and C#, F# and G# are a quarter-note higher compared to equal temperament. The intervals between G and B, C and E, F and G#, Bb and C#, and Eb and F# have a natural third—the interval between a major third and a minor third. On the Fantom-X, you can use Arabian temperament in the three keys of G, C and F.

<Example>

Note name	Equal temperament	Just Temperament (tonic C)	Arabian Scale
C	0	0	-6
C#	0	-8	+45
D	0	+4	-2
Eb	0	+16	-12
E	0	-14	-51
F	0	-2	-8
F#	0	-10	+43
G	0	+2	-4
G#	0	+14	+47
A	0	-16	0
Bb	0	+14	-10
B	0	-12	-49

Patch Scale Tune for C-B

Make scale tune settings for Patch mode.

Value: -64+ +63

Preview

Preview Mode

SINGLE: The notes specified by Note Number 1-4 parameter will sound successively one by one.

CHORD: The notes specified by Note Number 1-4 parameter will sound simultaneously.

PHRASE: The Phrase associated with the patch's type/category is played.

Preview 1-4 Note Number

Specify the pitch of the four notes that will sound when the Preview Mode parameter is set to "SINGLE" or "CHORD."

Value: C-1-G9

NOTE

If "PHRASE" is selected for the Preview Mode parameter, these settings will have no effect.

Preview 1-4 Velocity

Specify the velocity of the four notes that will sound when the Preview Mode parameter is set to "SINGLE" or "CHORD."

Value: 0-127

NOTE

If "PHRASE" is selected for the Preview Mode parameter, these settings will have no effect.

System Ctrl

Sys Ctrl 1–4 Source

System Control Assign selects the MIDI message used as the System Control.

System Control

This function, which departs from previously used methods, and instead allows you to use MIDI messages to change tone settings in realtime, is called the **Matrix Control** (p. 80). Similarly, the function allowing you to use MIDI messages to change multi-effects settings in realtime is called the **Multi-effects Control** (p. 214).

Normally, the Matrix Control is used for making patch settings, and the Multi-effects Control for making settings to patches, rhythm sets, and performances. However, if you do not need to change the MIDI messages used for matrix control or multi-effects control by each patch/rhythm set/performance, or if you want to use a specific MIDI message for matrix control or multi-effects control, you will want to make use of **System Control**. In other words, you could call the System Controls global Matrix Control/Multi-effects Control for the entire Fantom-X.

You can use up to four System Controls.

Value

OFF: The system control knob will not be used.
CC01–31, 33–95: Controller numbers 1–31, 33–95



For details on control change messages, refer to “**MIDI Implementation**” (p. 298).

PITCH BEND: Pitch Bend
AFTERTOUC: Aftertouch

Background

Background Picture

Select the file that is to be displayed as the screen background.

Value: 1–16

Screen Saver

Screen Saver Type

Select the type of screen saver.

Value: 1–16

Screen Saver Time

Set the time (minutes) until the screen saver begins working.

If this is OFF, the screen saver will not appear.

Value: OFF, 5–60 min.

Sampling

Default File Type

Specifies the file format used when saving a sample.

Value: WAV, AIFF

Pre Sample Time

The length of sound preceding the moment at which sampling was manually or automatically initiated that will be captured in the sample. This lets you prevent the attack portion of the sound from being omitted from the sample.

Value: 0–1000 ms

Trigger Level

Volume level at which sampling will begin when Auto Trig is ON. A setting of 0 is the minimum.

Value: 0–7

Gap Time

Length of silence at which the sample will be divided. Whenever there is a silent region longer than the specified time, the sample will be divided at that point, and the next sample number will be assigned to the sound that follows. This parameter is valid only when you are using Auto Divide Sampling.

Value: 500, 1000, 1500, 2000 ms

Input Select

Input source of the external input sound

Value

DIGITAL IN: DIGITAL INPUT jack
LINE-L-R: INPUT jacks L/R (stereo)
LINE-L: INPUT jack L (mono)
MIC: INPUT jack (mono, mic level)

Trimming Switch

If this is turned on, the Start point and End point settings will be automatically adjusted after sampling is performed, so any silent portions at the beginning or end of the sampled sound are excluded.

Value: OFF, ON

Skip Back Time

Specifies how much earlier in time that you want sampling to take place when you use Skip Back Sampling. If “OFF” selected, skip-back sampling cannot be performed.

Value: OFF, 5s–40s

Settings Common to All Modes (System Function)

Start up

Load Preset Samples at Startup

Specifies whether the preset samples will be loaded into memory at power-on (ON) or not (OFF).

Value: OFF, ON

Load User Samples at Startup

Specifies whether the samples of the user area and memory card will be loaded into memory at power-on (ON) or not (OFF).

Value: OFF, ON

Load Demo Song at Startup

Specifies whether the demo song will be loaded into the temporary area when you power up the Fantom-X (ON), or will not be loaded (OFF).

Rec Track Select (Recording Track Select)

This specifies whether track selection will be automatic or manual when recording on the sequencer.

Value

Manual: You'll be able to select the track number manually. This is convenient when you want to record a performance that consists of more than one channel.

Auto: The phrase track of the same number as the current part will be selected automatically. This is convenient when you want to record only one channel in a track.

Power Up Mode

This setting allows you to choose the mode that you want the Fantom-X to be in when it is powered up.

Value

PATCH: The Fantom-X will be in Patch mode when you turn on the power.

PERFORMANCE: The Fantom-X will be in Performance mode when you turn on the power.

System Information

cf.

For details on the indicating, refer to "How to Make System Function Settings" (p. 225).

Features

Displays the main features of the Fantom-X.

Memory Info (Memory Information)

Displays the amount of memory installed.

SRX Info (SRX Information)

Displays the name of the wave expansion board that is installed.

Version Info (Version Information)

Displays the version of the Fantom-X.

Data Management Functions

Reset to Default Factory Settings (Factory Reset)

Basic Procedure

1. Press [MENU].
2. Press ▲ or ▼ to select "Utility."
3. Press [ENTER].
The Utility menu screen will appear.



4. Press [F1]–[F4] to select the operation that you want to execute.
 - [F1 (User Backup)]
Save user data to a memory card.
 - [F2 (User Restore)]
Load user data from a memory card.
 - [F3 (Factory Reset)]
Restore the factory settings.
 - [F4 (Librarian)]
When you want to use the included Fantom-X Librarian software, or when you want to receive system exclusive messages from an external device to rewrite the user memory, press [F4 (Librarian)] to put the Fantom-X in Librarian mode.

* For details on using Fantom-X Librarian, refer to "Using Fantom-X Librarian" (p. 236).

Backing Up User Data (User Backup)

Here's how all user data in the user area can be saved on a memory card.

The following user data will be saved.

- Performances
- Rhythm Groups
- Arpeggio styles
- Patches
- Multisamples
- Chord forms
- Rhythm sets
- Songs
- System settings
- Rhythm Patterns
- Samples

* You need to have a sufficient amount of free space available on the memory card in order to perform a User Backup; up to 64 MB may be required.

1. Insert a memory card into the slot.
2. In the Utility screen, press [F1 (User Backup)].
A message will ask you for confirmation.
3. To execute the backup, press [F8 (Exec)].

* To cancel, press [F7 (Cancel)].

NOTE

Fantom-X backup data must not be used to perform a Restore into other models in the Fantom-X series (i.e., models other than the Fantom-X6/X7/X8).

Restoring User Data that You Backed Up (User Restore)

Here's how user data saved on a memory card by the User Backup operation can be reloaded back into the user memory of the Fantom-X. When you execute User Restore, the current contents of the user area will be completely erased.

1. Into the slot, insert the memory card on which user data has been saved.
2. In the Utility screen, press [F2 (User Restore)].
A message will ask you for confirmation.
3. To proceed with the restoration, press [F8 (Exec)].

* To cancel, press [F7 (Cancel)].
4. When the display indicates "Please Power Off," turn the power off, then on again.

NOTE

If you have added files to the Fantom-X's internal memory (such as the TMP folder) after executing the User Backup operation, the "User Area Full!" message may appear when you attempt to execute the User Restore operation, and the Restore may not be successful. If this occurs, delete the files you added after the backup (p. 224), and then try the Restore operation again.

Factory Reset

This restores all data in the Fantom-X to the factory-set condition (Factory Reset).

NOTE

If there is important data you've created that's stored in the Fantom-X's User memory, all such data is discarded when a Factory Reset is performed (the data of the internal user memory will be lost). If you want to keep the existing data, save it on a memory card (p. 235) or save it via USB to your computer (Using Fantom-X Librarian (p. 236)).

1. Press [MENU] to open the Menu window.
2. Press ▲ or ▼ to select "Utility," and then press [ENTER].
3. Press [F3 (Factory Reset)].
A message will ask confirmation.
4. Press [F8 (Exec)] to execute the Factory Reset.

* To cancel, press [F7 (Cancel)].
5. When the display indicates "Please Power Off," turn the power off, then on again.

Using Fantom-X Editor

To help you take even greater advantage of its functionality, the Fantom-X comes with Fantom-X Editor software. Fantom-X Editor assigns parameters to sliders and knobs in the computer screen, allowing you to work efficiently in a graphical editing environment.

Installing Fantom-X Editor into Your Computer

Detailed instructions on installing the software can be found in the online manual contained on the Fantom-X Editor CD-ROM.

- **Windows users**

In the Fantom-X Editor CD-ROM, open the Readme_E.txt.

- **Macintosh users**

In the Fantom-X Editor CD-ROM, open the Readme(English).txt.

Making Connections

1. **Make sure that the System USB setting is set to MIDI.**

Refer to **Selecting MIDI Mode** (p. 218).

* If it is set to Storage, you cannot use the editor via a USB connection.

2. **In order to use Fantom-X Editor, use an USB cable (sold separately) to connect the Fantom-X and your computer.**

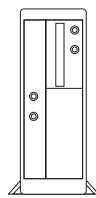
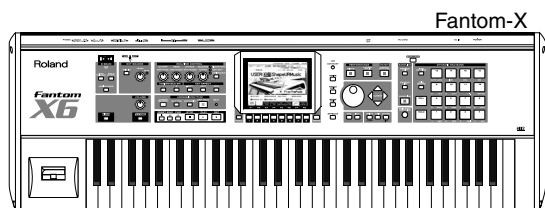

Windows

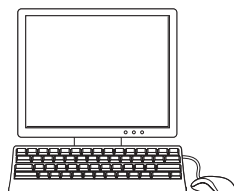

Macintosh

Using Fantom-X Librarian

Fantom-X Librarian is software that lets you manage libraries of Fantom-X parameter data on your computer. It provides an efficient way to manage patch, rhythm set, and performance data.

In order to use the librarian included on the "Fantom-X Editor" CD-ROM, you will need to put the Fantom-X in Librarian mode.

* The same is true when you want to use a separately sold librarian.

1. **Press [MENU].**
2. **Use ▲ or ▼ to select "Utility" and then press [ENTER].**
3. **Press [F4 (Librarian)].**

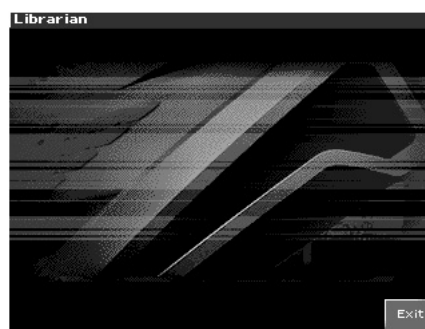

Librarian mode will be selected. In Librarian mode, system exclusive messages sent from an external MIDI device can overwrite the settings in user memory. You will be unable to operate the panel of the Fantom-X.

4. **Press [EXIT] or [F8 (EXIT)] to exit Librarian mode and return to the normal state.**

Fantom-X Editor System Requirements

System Requirements (Windows)

- Operating System
 - Microsoft® Windows® XP
 - Microsoft® Windows® Me
 - Microsoft® Windows® 2000 Professional
 - Microsoft® Windows® 98
 - CPU/Clock
 - Pentium®/Celeron™ processor 400 MHz or higher
 - Pentium® III 500 MHz or higher (recommended)
 - Memory (RAM)
 - 128 M bytes or more
 - 256 M bytes or more (recommended)
 - Display/Colors
 - 800 x 600 or higher / 65,536 colors (16 bit High Color) or more
 - 1024 x 768 or higher (recommended)
 - Hard Disk
 - 120 MB or more
- * Microsoft and Windows are registered trademarks of Microsoft Corporation.
- * Windows® is known officially as: "Microsoft® Windows® operating system."
- * Pentium is a registered trademark of Intel Corporation.

System Requirements (Mac OS)

- Operating System
 - Mac OS (Classic) 8.6 and 9.x
 - Mac OS (X) 10.2 or later
 - CPU/Clock
 - PowerPC G3 233 MHz or higher (Classic)
 - PowerPC G3 500 MHz or higher (Mac OS X)
 - Memory (RAM)
 - 128 MB or more
 - 256 MB or more (recommended)
 - Display/Colors
 - 800 x 600 or higher / 32,000 colors or more
 - 1024 x 768 or higher (recommended)
 - Hard Disk
 - 120 M bytes or more
 - Others
 - OMS 2.0 or later (Classic)
- * Apple and Macintosh are registered trademark of Apple Computer, Inc.
- * MacOS is a trademark of Apple Computer, Inc.
- * OMS is a registered trademark of Opcode Systems, Inc.

About V-LINK

What is V-LINK?

V-LINK (**V-LINK**) is a function that allows music and images to be performed together. By using MIDI to connect two or more V-LINK compatible devices, you can easily enjoy performing a wide range of visual effects that are linked to the expressive elements of a music performance.

(Examples)

By using the Fantom-X and Edirol DV-7PR together, you can:

- Make Edirol DV-7PR playback settings remotely from the Fantom-X.
- Use the Fantom-X's sequencer to enjoy synchronized music and video.
- Use the Fantom-X to switch the Edirol DV-7PR's images (clips/palettes).
- Use the Fantom-X's knobs to adjust the brightness or color of the image.

* In order to use V-LINK with the Fantom-X and Edirol DV-7PR, you will need to make connections using an Edirol UM1/UM-1S (sold separately).

Connection Examples

Use a UM-1 to connect the Fantom-X's MIDI OUT connector to the DV-7PR's remote jack.

NOTE

Before connecting this unit to other devices, turn off the power to all units. This will help prevent malfunctions and/or damage to speakers or other devices.

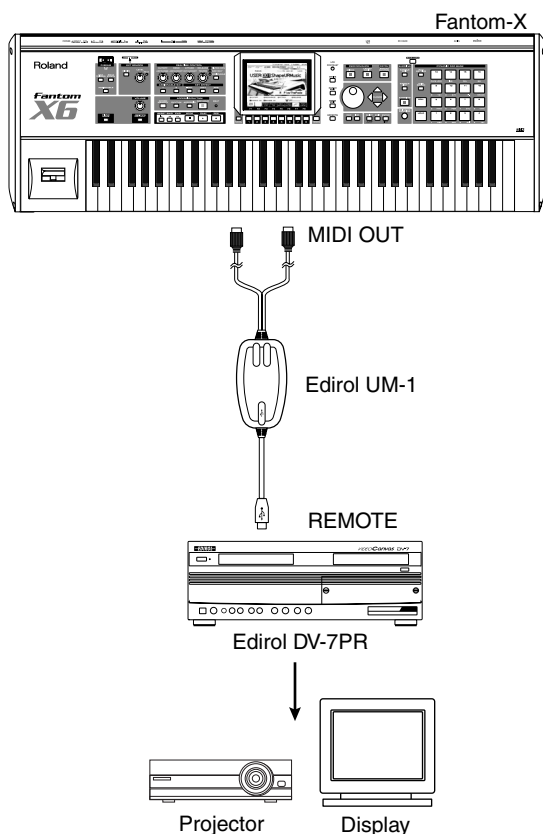

Turning the V-LINK ON/OFF

1. In the left of the panel, press [V-LINK] so the indicator is lighted.

The V-LINK setting will be on.

In this state, you can operate the Fantom-X to manipulate images in sync with your performance.

MEMO

Each mode will function as usual even if V-LINK is on.

2. Press [V-LINK] again.

The V-LINK button will go out, and the V-LINK setting will be off.

V-LINK Settings

1. Holding down [SHIFT] and pressing [V-LINK] to access the V-LINK SETUP screen.
2. Press [CURSOR] to move the cursor to a parameter, and turn the VALUE dial or use [INC][DEC] to set the value.



* Specify the Pad Mode by pressing [F1 (Clip)] or [F2 (Palett)].

3. If you want to keep your settings, press [F8 (System Write)].
4. Press [F7 (Exit)] or [EXIT].
You're returned to the previous screen.

V-LINK Parameters

Note Tx Ch

Value: 1-16

MIDI channel that will switch Edirol DV-7PR clips/palettes and will control dissolve time.

Clip 1 Note No.

Pads 1–16 correspond to Edirol DV-7PR clips (or palettes). We recommend that you press [PAD SETTING] to access the Pad setting screen, and set to “Note,” using Quick Setup (p. 161) and set Clip1 Note No. to the same value as the “Pad Base Note” setting.

Value: 0(C-1)-127(G9)

Dissolve Time

Control change number that controls the dissolve time (time over which the image switches)

Value: OFF, CC1, CC5, CC7, CC10, CC11, CC71-74, CC91-93, Channel Aftertouch

Ctrl Tx Ch

MIDI channel that will control the Edirol DV-7PR color Cb/Cr, brightness, and video effect switching

Value: 1-16

Play Speed Ctrl

Range of video playback speed The three values are the playback speeds (multiples of normal speed) at the left, center, and right positions of the pitch bend.

Value: 0.0-1.0-2.0, 0.5-1.0-2.0, 0.0-1.0-4.0, 0.5-1.0-4.0, 0.0-1.0-8.0, 0.5-1.0-8.0, 0.0-1.0-16.0, 0.5-1.0-16.0, 0.0-1.0-32.0, 0.5-1.0-32.0, 0.0-2.0-4.0, 0.0-4.0-8.0, 0.0-8.0-16.0, 0.0-16.0-32.0, -2.0-1.0-4.0, -6.0-1.0-8.0

Color Cb Ctrl

Control change number that controls the Cb color of the image

Color Cr Ctrl

Control change number that controls the Cr color of the image

Brightness Ctrl

Control change number that controls the brightness of the image

VFX1–4 Ctrl

Control change number that controls the video effect

* VFX2–4 are not supported by the Edirol DV-7PR.

Fade Ctrl

Control change number that controls the output fade

Value: OFF, CC1, CC5, CC7, CC10, CC11, CC71-74, CC91-93, Channel Aftertouch

PAD MODE

Selects whether the pads will switch clips or palettes.

Value: CLIP, PALETT

Press [F1 (Clip)]: switch clips

Press [F2 (Palett)]: switch palettes

Local Sw

Specifies whether the internal sound generator is disconnected (OFF) from the pads, or not (ON).

Procedure: Press [F5 (Local Sw)].

Value: OFF, ON

Clip filter

(check boxes 1-32)

Clips that are checked can be switched. Enable/disable switching for each clip

Value: OFF, ON

Using the Clip Filter

For example, suppose that of the rhythm set you input in the part used for V-LINK (i.e., the part of the same number as the Note Tx Channel), you want only the kick and snare to switch clips. In this case, check only the clips that correspond to the note numbers of the kick and snare. The clips will switch when the kick or snare plays.

Resetting the Image

Clip Reset

Turn off the image (solid black).

Procedure: Press [F3 (Clip Reset)].

All Reset

The effect applied to the image will be reset, and brightness, color difference, etc. will all return to the default value.

Procedure: Press [F4 (All Reset)].

* For details on clips/palettes, dissolve time, color difference signals (Cb/Cr), refer to the Edirol DV-7PR manual.

NOTE

The Phantom-X does not support the Edirol DV-7PR's dual stream mode.

Installing the Wave Expansion Board

Up to four optional Wave Expansion Boards (SRX series; sold separately) can be installed in the Fantom-X.

Wave Expansion Boards store Wave data, patches, and rhythm sets, and by equipping the Fantom-X with these boards, you can greatly expand your sound palette.

Cautions When Installing an Wave Expansion Board

- To avoid the risk of damage to internal components that can be caused by static electricity, please carefully observe the following whenever you handle the board.
 - Before you touch the board, always first grasp a metal object (such as a water pipe), so you are sure that any static electricity you might have been carrying has been discharged.
 - When handling the board, grasp it only by its edges. Avoid touching any of the electronic components or connectors.
 - Save the bag in which the board was originally shipped, and put the board back into it whenever you need to store or transport it.
- Use a Phillips screwdriver that is suitable for the size of the screw (a number 2 screwdriver, Fantom-X6/X7 only). If an unsuitable screwdriver is used, the head of the screw may be stripped.
- To remove a screw, rotate the screwdriver counter-clockwise. To tighten the screws, rotate the screwdriver clockwise.



- When installing Wave Expansion Boards, remove only the specified screws.
- Be careful that the screws you remove do not drop into the interior of the Fantom-X.
- Do not leave the bottom cover removed. After installation of the Wave Expansion Boards is complete, be sure to replace the cover.
- Be careful not to cut your hand on the opening for installing the board.
- Do not touch any of the printed circuit pathways or connection terminals.
- Do not touch any of the printed circuit pathways or connection terminals.
- Never use excessive force when installing a circuit board. If it doesn't fit properly on the first attempt, remove the board and try again.
- When circuit board installation is complete, double-check your work.
- Always turn the unit off and unplug the power cord before attempting installation of the circuit board (SRX series).
- Install only the specified circuit board(s) (SRX series). Remove only the specified screws.

How to Install a Wave Expansion Board

Install the Wave Expansion Boards after removing the panel cover. Boards can be installed in the EXP A–EXP D slots. These slots correspond with the Wave Expansion Board groups (XP-A–XP-D) when the expansion Wave, patches, and rhythm sets are used.

1. **Before installing the Wave Expansion Board, turn off the power of the Fantom-X and all connected devices, and disconnect all cables, including the Power cable, from the Fantom-X.**
2. **From the Fantom-X, remove only the screws shown in the following diagram, and detach the cover. On the Fantom-X6/X7, the cover is located on the bottom panel. On the Fantom-X8, it is located on the front panel.**

* A hex wrench is included with the Fantom-X8. When removing screws, you must use this hex wrench.

Fantom-X6/X7 : bottom

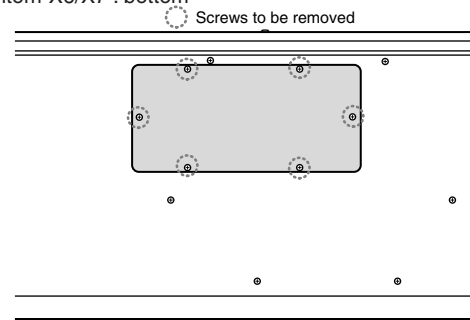

Fantom-X8 : Front

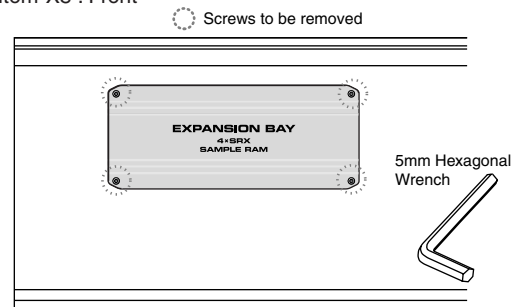

NOTE

When turning the unit upside-down, get a bunch of newspapers or magazines, and place them under the four corners or at both ends to prevent damage to the buttons and controls. Also, you should try to orient the unit so no buttons or controls get damaged.

When turning the unit upside-down, handle with care to avoid dropping it, or allowing it to fall or tip over.

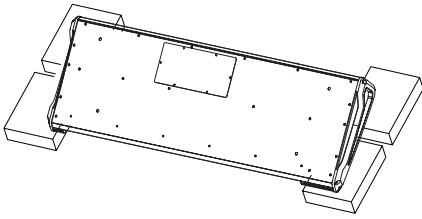

3. There are four slots inside. As shown in the following illustration, plug the connector of the Wave Expansion Board into the connector of the relevant slot, and at the same time insert the board holder through the hole of the Wave Expansion Board.

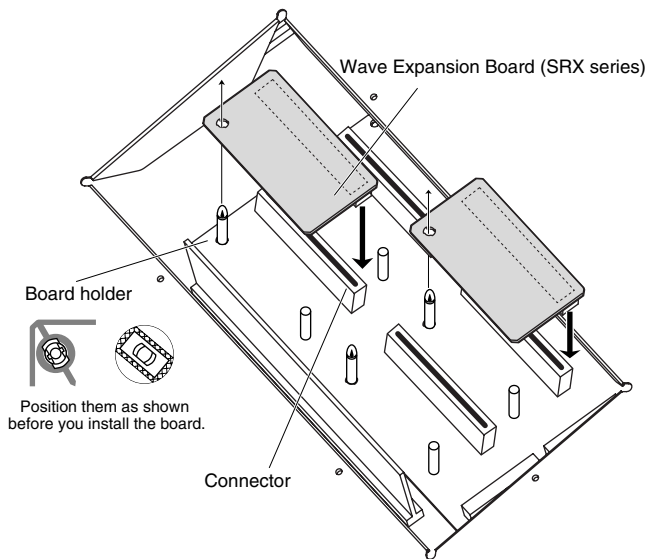

NOTE

If you install expansion boards of the same type, only one board will be detected.

4. Use the Installation Tool supplied with the Wave Expansion Board to turn the holders in the LOCK direction, so the board will be fastened in place.

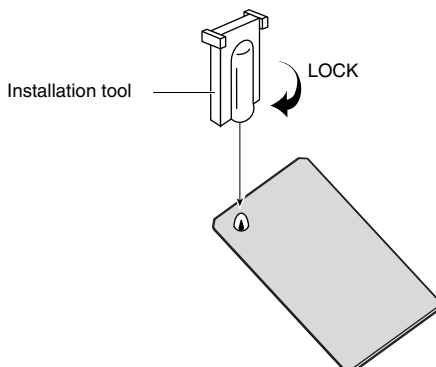

5. Use the screws that you removed in step 2 to fasten the cover back in place.

Checking the Installed Wave Expansion Boards

After installation of the Wave Expansion Boards has been completed, check to confirm that the installed boards are being recognized correctly.

1. Turn on the power, as described in “Turning On the Power” (p. 21).
2. Press [MENU] to open the Menu window.
3. Press ▲ or ▼ to select “System,” and then press [ENTER].
4. Press [F4 (System Info)].
5. Press [F1 (↑)] or [F2 (↓)] to select “SRX Info.”
The System screen appears. Verify that the name of the installed Wave Expansion Board is displayed.

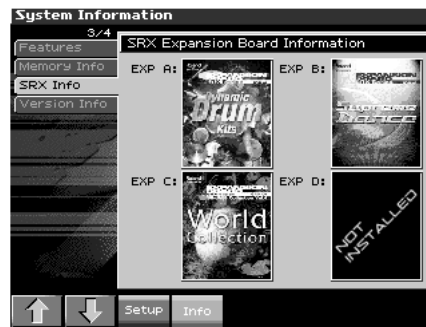

NOTE

If an indication of “NOT INSTALLED” appears for a slot in which you installed a wave expansion board, it is possible that the board is not being recognized correctly. Re-install the Wave Expansion Board correctly.

6. Press [EXIT] to exit the System Menu screen.

(French Language for Canadian Safety Standard)

Un maximum de trois cartes d'expansion Wave (quatre cartes SRX) peuvent être installées dans le Fantom-X.

Les cartes d'expansion Wave emmagasinent des données Wave, correctifs et rythmes, et en ajoutant ces cartes au Fantom-X, il est possible d'élargir considérablement la palette de sons.

Précautions à prendre lors de l'installation d'une carte d'expansion Wave

- Veuillez suivre attentivement les instructions suivantes quand vous manipulez la carte afin d'éviter tout risque d'endommagement des pièces internes par l'électricité statique.
 - Toujours toucher un objet métallique relié à la terre (comme un tuyau par exemple) avant de manipuler la carte pour vous décharger de l'électricité statique que vous auriez pu accumuler.
 - Lorsque vous manipulez la carte, la tenir par les côtés. Évitez de toucher aux composants ou aux connecteurs.
 - Conservez le sachet d'origine dans lequel était la carte lors de l'envoi et remettez la carte dedans si vous devez la ranger ou la transporter.
- Utilisez un tournevis de type Phillips de la taille adaptée à celle des vis (tournevis numéro 2, Fantom-X6/X7 uniquement). Un tournevis inadéquat peut endommager la tête de la vis.
- Pour retirer une vis, tourner le tournevis dans le sens contraire des aiguilles d'une montre. Pour serrer les vis, tourner le tournevis dans le sens des aiguilles d'une montre.



- Pour installer les cartes d'expansion Wave, retirer uniquement les vis mentionnées.
- Assurez-vous que les vis retirées ne tombent pas dans le Fantom-X.
- Ne pas laisser le panneau de protection avant détacher. S'assurer de l'avoir rattaché après avoir installé le disque dur.
- Faites attention de ne pas vous couper sur l'ouverture d'installation de la carte.
- Ne pas toucher aux circuits imprimés ou aux connecteurs.
- Ne jamais forcer lors de l'installation de la carte de circuits imprimés. Si la carte s'ajuste mal au premier essai, enlevez la carte et recommencez l'installation.
- Quand l'installation de la carte de circuits imprimés est terminée, vérifiez si tout est bien installé.
- Toujours éteindre et débrancher l'appareil avant de commencer l'installation de la carte. (SRX series).
- N'installez que les cartes de circuits imprimés spécifiées (SRX series). Enlevez seulement les vis indiquées.

Installation d'une carte d'expansion Wave

Avant d'installer la carte d'expansion Wave, retirez le panneau inférieur. Les cartes peuvent être installées dans les emplacements SRX-A–SRX-D. Ces fentes correspondent aux groupes de cartes d'expansion Wave (XP-A–XP-D) lorsque l'expansion Wave, les correctifs et rythmes sont utilisés.

1. Avant d'installer la carte d'expansion Wave, coupez l'alimentation du Fantom-X et de tous les appareils branchés, et débranchez tous les câbles du Fantom-X, y compris le câble d'alimentation.
2. Sur les modèles Fantom-X, retirer uniquement les vis illustrées dans le schéma ci-dessous et retirer le couvercle. Sur le modèle Fantom-X6/X7, le couvercle est situé sur le panneau inférieur. Sur le modèle Fantom-X8, il est placé sur le panneau avant.
 - * Une clé hexagonale est fournie avec le Fantom-X8. Il faut utiliser cette clé pour retirer les vis.

Fantom-X6/X7 : Panneau inférieur
○ Vis à enlever

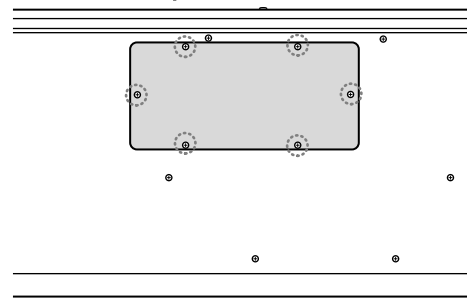

Fantom-X8 : Panneau avant
○ Vis à enlever

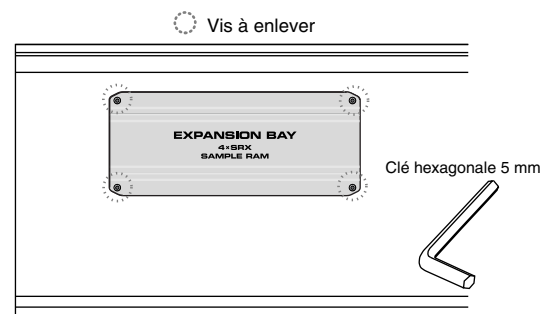

NOTE

Lorsque vous déposez le Fantom-X face vers le bas, placez des piles de journaux ou de magazines sous les quatre coins (ou des deux côtés) pour le soutenir. Ainsi, les boutons, manettes et autres pièces ne seront pas endommagés.

En plaçant l'appareil sens dessus dessous, manipulez-le avec soin pour éviter de l'échapper, de le laisser tomber ou de se renverser.

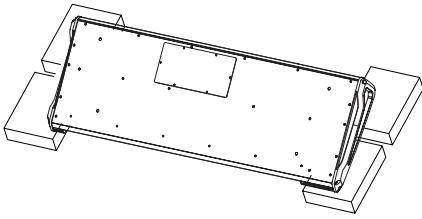

- 3. Il y a quatre emplacements à l'intérieur. Comme le montre l'illustration ci-dessous, branchez le connecteur de la carte d'expansion Wave dans la fente appropriée et, en même temps, insérez le support de carte de circuits imprimés dans l'ouverture de la carte d'expansion Wave.**

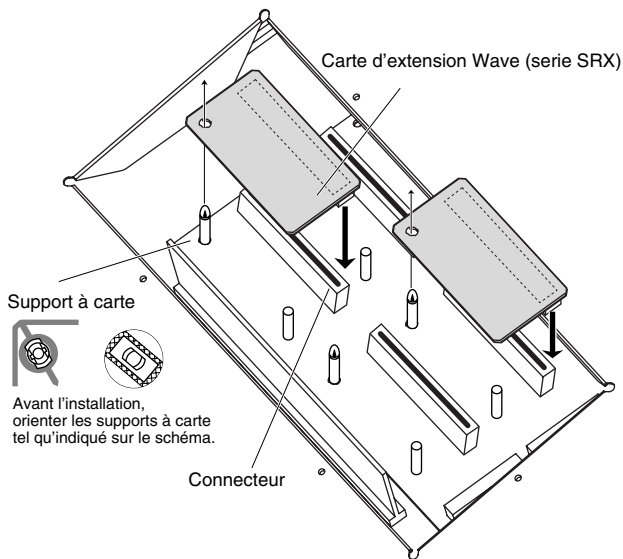

NOTE

Si plusieurs cartes d'expansion du même type sont installées, une seule sera détectée.

- 4. Utilisez l'outil d'installation fourni avec la carte d'expansion Wave pour tourner les supports en position LOCK (verrouillé) afin de retenir la carte en place.**

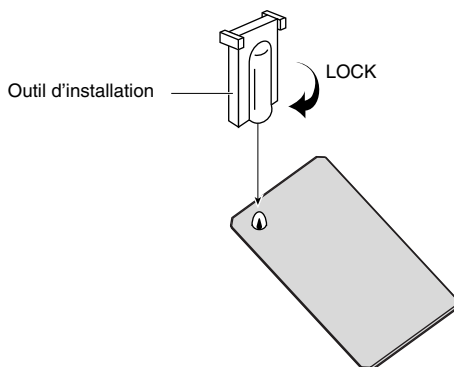

- 5. Remettez le couvercle en place à l'aide des vis retirées à l'étape 2.**

Vérification des cartes d'extension audio après installation

Lorsque l'installation des cartes d'extension audio est terminée, procéder à une vérification pour s'assurer que l'ordinateur les identifie correctement.

1. Mettre sous tension de la façon décrite sous "Turning On the Power" (p. 21).
2. Appuyez sur la touche [MENU] pour ouvrir la fenêtre Menu.
3. Appuyer sur ▲ ou sur ▼ pour sélectionner "System" et appuyer ensuite sur [ENTER].
4. Appuyer sur [F4 (System Info)].
5. Appuyer sur [F1 (⌂)] ou sur [F2 (⇩)] pour sélectionner "SRX Info."

L'écran System Edit s'affiche. Vérifiez que le nom de la carte d'expansion Wave installée s'est affiché.



NOTE

Si "NOT CONNECTED" est affiché à côté du nom de la fente dans laquelle la carte est installée, il est possible que la carte d'extension audio installée ne soit pas reconnue correctement. Réinstaller correctement la carte d'extension audio.



- 6. Appuyer sur [EXIT] pour quitter la fenêtre du menu du système.**

Expanding the Memory

The Fantom-X comes with 32 MB of memory into which audio samples can be loaded. However, in some cases, 32 MB of memory will be insufficient for loading large amounts of data. In such a case, you will have to add separately sold memory (DIMM). Memory can be expanded up to 64/128/256/512 MB.

Before expanding the memory, consult with your retailer, the nearest Roland Service Center, or an authorized Roland distributor.

Precautions for Expanding Memory

- To avoid the risk of damage to internal components that can be caused by static electricity, please carefully observe the following whenever you handle the board.
 - Before you touch the board, always first grasp a metal object (such as a water pipe), so you are sure that any static electricity you might have been carrying has been discharged.
 - When handling the board, grasp it only by its edges. Avoid touching any of the electronic components or connectors.
 - Save the bag in which the board was originally shipped, and put the board back into it whenever you need to store or transport it.
 - Use a Phillips screwdriver that is suitable for the size of the screw (a number 2 screwdriver, Fantom-X6/X7 only). If an unsuitable screwdriver is used, the head of the screw may be stripped.
 - To remove a screw, rotate the screwdriver counter-clockwise. To tighten the screws, rotate the screwdriver clockwise.
- 
- loosen () tighten
- Be careful that the screws you remove do not drop into the interior of the Fantom-X.
 - Be careful not to cut your hand on the edge of the cover or the opening edge while removing the cover.
 - Do not touch any of the printed circuit pathways or connection terminals.
 - Never use excessive force when installing a circuit board. If it doesn't fit properly on the first attempt, remove the board and try again.
 - When circuit board installation is complete, double-check your work.
 - Always turn the unit off and unplug the power cord before attempting installation of the memory DIMM board.
 - Install only the specified memory DIMM board. Remove only the specified screws.
 - When turning the unit upside-down, get a bunch of newspapers or magazines, and place them under the four corners or at both ends to prevent damage to the buttons and controls. Also, you should try to orient the unit so no buttons or controls get damaged.
 - When turning the unit upside-down, handle with care to avoid dropping it, or allowing it to fall or tip over.
 - Do not leave the bottom cover removed. After installation of the memory module is complete, be sure to replace the cover.

How to Expand the Memory

Install the memory module after removing the bottom panel cover.

- 1. Before expanding the memory, turn off the power of the Fantom-X and all connected devices, and disconnect all cables, including the Power cable, from the Fantom-X.**
 - 2. From the Fantom-X, remove only the screws shown in the following diagram, and detach the cover. On the Fantom-X6/X7, the cover is located on the bottom panel. On the Fantom-X8, it is located on the front panel. From the Fantom-X, remove only the screws shown in the following diagram, and detach the cover.**
- * A hex wrench is included with the Fantom-X8. When removing screws, you must use this hex wrench.

Fantom-X6/X7 : bottom

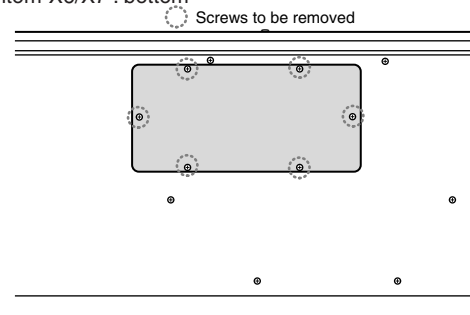

Fantom-X8 : Front

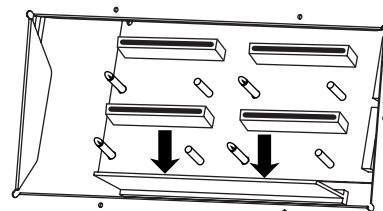
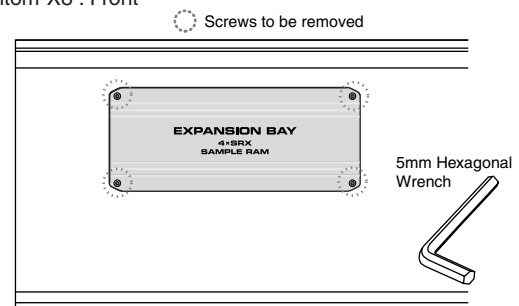

- 3. Press outward on the white clips at either end of the socket so they are in their downward position.**

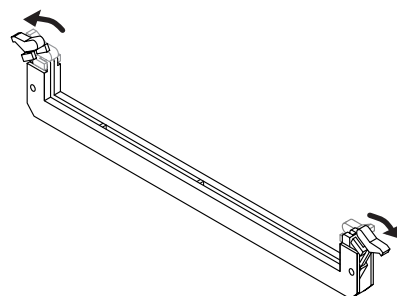

4. Paying attention to the location of the notches on the memory module and the correct orientation, insert the module vertically within the guides at either side of the socket.

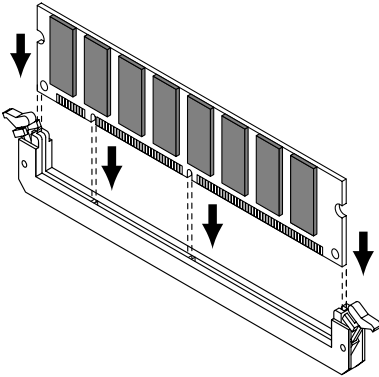

TIP

If you have difficulty inserting the memory module, try tilting it a bit and inserting one end at a time.

5. Move the white clips upward, and press them until the memory module is locked in place.

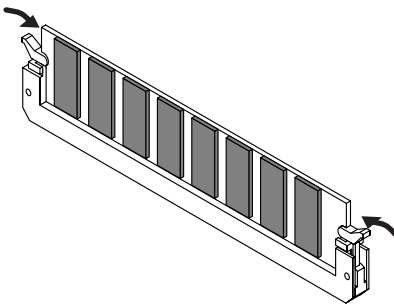

6. Use the screws that you removed in step 2 to fasten the cover back in place.

Removing the Memory

To remove the memory module, reverse the installation procedure.

1. Simultaneously press outward the white clips located at either end of the socket.

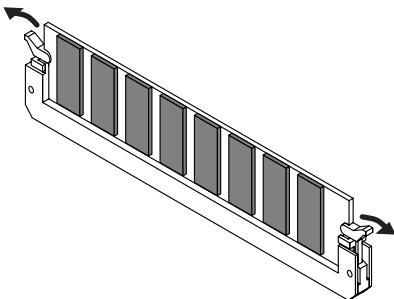

2. Remove the memory module from the socket.

Checking that memory is installed correctly

1. Turn on the power, as described in "Turning On the Power" (p. 21).
2. Press [MENU] to open the Menu window.
3. Press ▲ or ▼ to select "System," and then press [ENTER].
4. Press [ENTER].
5. Press [F4 (System Info)].
6. Press [F1 (↑)] or [F2 (↓)] to select "SRX Info." Verify that the screen correctly shows the amount of memory you installed.

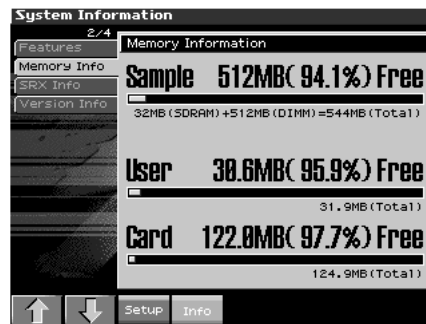

7. Press [EXIT] to exit the System screen.

* If the correct amount of memory is not shown, it is possible that the memory is not being recognized properly. Turn off the power as described in "Turning Off the Power" (p. 22), and re-install the memory correctly.

Specifications of the expansion memory (DIMM) that can be used

Number of pins:	168-pin
Speed:	100 MHz (PC100 CL=2) 133 MHz (PC133 CL=3)
Voltage:	3.3 V
Capacity:	64/128/256/512 MB
Board height:	38 mm or less

NOTE

The Fantom-X has been confirmed to work with standard memory that meets the above specifications. However, we cannot guarantee that all memory of these specifications will work correctly. Please be aware that even with identical specifications, differences in the design of the memory module or the conditions of use may mean that a memory module may not be usable.

Le Fantom-X est livré avec une mémoire de 32 Mo dans laquelle les échantillons audio peuvent être chargés. Toutefois, dans certains cas, une mémoire de 32 Mo sera insuffisante pour charger de grandes quantités de données. Il faudra alors ajouter des modules de mémoire vendus séparément (DIMM). La mémoire est extensible jusqu'à 64/128/256/512 Mo.

Avant d'ajouter de la mémoire, consulter le détaillant, le centre de service Roland le plus proche ou un distributeur autorisé Roland.

Précautions à prendre lors de l'ajout de mémoire

- Veuillez suivre attentivement les instructions suivantes quand vous manipulez la carte afin d'éviter tout risque d'endommagement des pièces internes par l'électricité statique.
- Toujours toucher un objet métallique relié à la terre (comme un tuyau par exemple) avant de manipuler la carte pour vous décharger de l'électricité statique que vous auriez pu accumuler.
- Lorsque vous manipulez la carte, la tenir par les côtés. Évitez de toucher aux composants ou aux connecteurs.
- Conservez le sachet d'origine dans lequel était la carte lors de l'envoi et remettez la carte dedans si vous devez la ranger ou la transporter.
- Utilisez un tournevis de type Phillips de la taille adaptée à celle des vis (tournevis numéro 2, Fantom-X6/X7 uniquement). Un tournevis inadéquat peut endommager la tête de la vis.
- Pour retirer une vis, tourner le tournevis dans le sens contraire des aiguilles d'une montre. Pour serrer les vis, tourner le tournevis dans le sens des aiguilles d'une montre.



- Assurez-vous que les vis que vous retirez ne tombent pas à l'intérieur du Fantom-X.
- Faites attention de ne pas vous couper sur le bord du couvercle ou de l'ouverture lorsque vous retirez le couvercle.
- Ne pas toucher aux circuits imprimés ou aux connecteurs.
- Ne jamais forcer lors de l'installation de la carte de circuits imprimés. Si la carte s'ajuste mal au premier essai, enlevez la carte et recommencez l'installation.
- Quand l'installation de la carte de circuits imprimés est terminée, revérifiez si tout est bien installé.
- Avant de procéder à l'installation d'un module DIMM, il faut toujours mettre l'unité hors tension et débrancher le câble d'alimentation.
- Installez uniquement le module DIMM spécifié. Retirez uniquement les vis spécifiées.
- Lorsque vous déposez le Fantom-X face vers le bas, placez des piles de journaux ou de magazines sous les quatre coins (ou des deux côtés) pour le soutenir. Ainsi, les boutons, manettes et autres pièces ne seront pas endommagés.
- En plaçant l'appareil sens dessus dessous, manipulez-le avec soin pour éviter de l'échapper, de le laisser tomber ou de se renverser.
- Une fois l'installation du module terminée, remettez le couvercle en place.

Installation du module de mémoire

Installez le module de mémoire après avoir retiré le couvercle inférieur.

- 1. Avant d'installer la mémoire supplémentaire, mettez hors tension le Fantom-X et tous les périphériques connectés et débranchez tous les câbles, y compris le câble d'alimentation du Fantom-X.**
- 2. Sur les modèles Fantom-X, retirer uniquement les vis illustrées dans le schéma ci-dessous et retirer le couvercle. Sur le modèle Fantom-X6/X7, le couvercle est situé sur le panneau inférieur. Sur le modèle Fantom-X8, il est placé sur le panneau avant.**

* Une clé hexagonale est fournie avec le Fantom-X8. Il faut utiliser cette clé pour retirer les vis.

Fantom-X6/X7 : Panneau inférieur

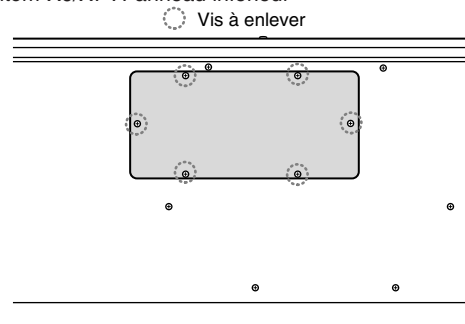

Fantom-X8 : Panneau avant

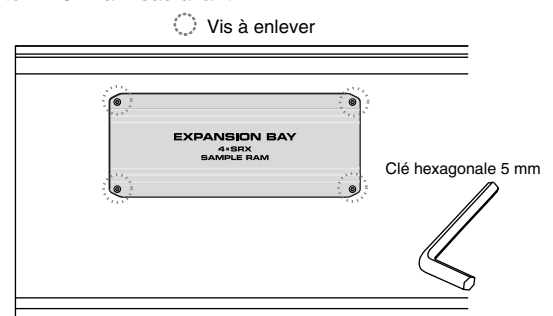

- 3. Appuyez sur les clips blancs à l'extrémité de la prise qui devraient être orientés vers le bas.**

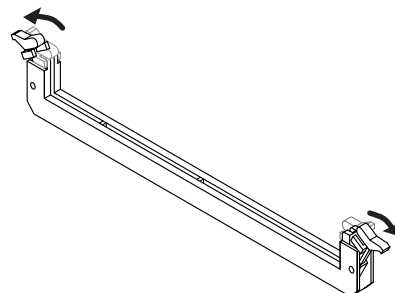

4. Prenez bien note de l'emplacement et de l'orientation de l'encoche du module de mémoire et insérez-le verticalement à l'intérieur des guides qui se trouvent de chaque côté de la prise.

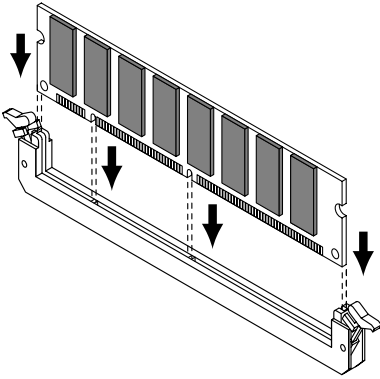

* Si vous éprouvez de la difficulté à insérer le module de mémoire, inclinez-le légèrement et insérez une extrémité à la fois.

5. Ramenez les clips blancs vers le haut et appuyez dessus jusqu'à ce que le module de mémoire soit verrouillé en place.

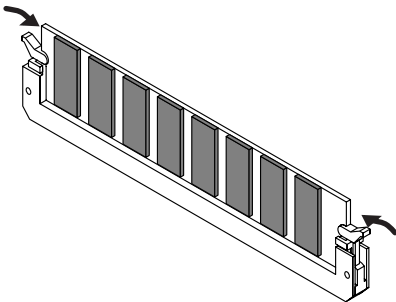

6. À l'aide des vis retirées à l'étape 2, remettez le couvercle en place.

Retrait du module de mémoire

Pour retirer le module de mémoire, procédez à l'inverse de la procédure d'installation.

1. Appuyez simultanément, vers l'extérieur, sur les clips blancs situés aux extrémités de la prise.

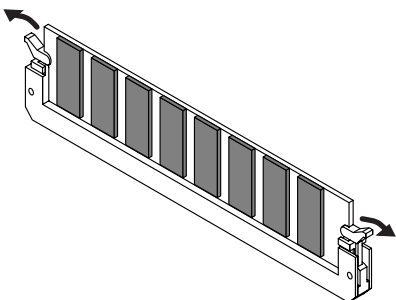

2. Retirez le module de mémoire de la prise.

Vérifier que la mémoire est installée correctement

1. Mettre sous tension de la façon décrite sous "Turning On the Power" (p. 21).
2. Appuyez sur la touche [MENU] pour ouvrir la fenêtre Menu.
3. Appuyer sur ▲ ou sur ▼ pour sélectionner "System" et appuyer ensuite sur [ENTER].
4. Appuyer sur [ENTER].
5. Appuyer sur [F4 (System Info)].
6. Appuyer sur [F1 (i)] ou sur [F2 (j)] pour sélectionner "SRX Info."

S'assurer de lire dans la fenêtre la taille de la mémoire que vous avez installée.

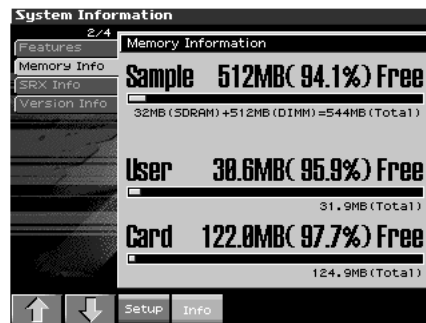

7. Appuyer sur [EXIT] pour quitter la fenêtre du menu du système.

* Si la taille de la mémoire dans la fenêtre n'est pas exacte, il est possible que la mémoire n'ait pas été détectée correctement. Éteindre tel que décrit sous "Turning Off the Power" (p. 22), et réinstaller la mémoire conformément aux instructions.

Spécifications des modules de mémoire (DIMM) qui peuvent être utilisés

Nombre de broches:	168-pin
Vitesse:	100 MHz (PC100 CL=2) 133 MHz (PC133 CL=3)
Tension:	3.3 V
Capacité:	64/128/256/512 MB
Hauteur de la carte:	38 mm ou moins

NOTE

Il a été confirmé que le Fantom-X fonctionne avec la mémoire standard possédant les spécifications ci-dessus. Nous ne pouvons toutefois pas certifier que toutes les mémoires possédant ces spécifications fonctionneront correctement. Il faut se rappeler que même si les spécifications sont identiques, des différences dans la conception du module de mémoire ou les conditions d'utilisation peuvent faire en sorte qu'il n'est pas possible d'utiliser le module de mémoire.

Using a Memory Card

The Fantom-X features a PC card slot, allowing you to use not only PC card type memory cards, but also other types of media, such as CompactFlash and Smart Media, via the appropriate PC card adaptor.

Before Using the Memory Card

Make sure that the correct side of the card is facing upward, and insert it into the Fantom-X's PC card slot. When you need to remove the card, press the eject button located beside the card.

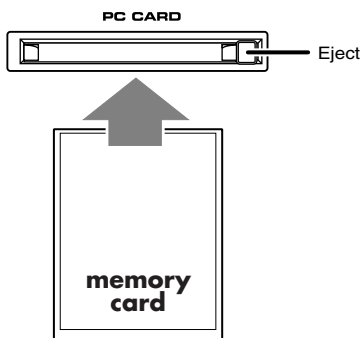

Writing data to the card

Patches, rhythm sets, performances, samples, and song data can be written to the card. For details on the writing procedure, refer to the explanation for the corresponding parameters.

Installing the PC Card Protector

The Fantom-X provides a PC card protector to prevent theft of the memory card. To install the PC card protector, use the following procedure.

1. Use a screwdriver to remove both of the screws from the bottom side of the PC CARD slot.
2. Insert the memory card into the PC CARD card slot.
3. Use the screws to fasten the PC card protector as shown below.

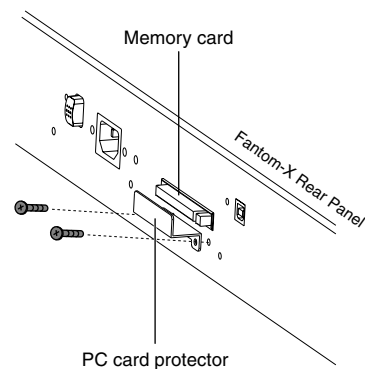

Troubleshooting

If the Fantom-X does not function in the way you expect, first check the following points. If this does not resolve the problem, consult your dealer or a nearby Roland Service Station.

* If any sort of message is being displayed on the screen during an operation, refer to **Error Messages** (p. 296).

Problems Concerning the Entire Fantom-X

Q The power does not turn on.

A Make sure that the Fantom-X's AC cord is connected correctly to its power inlet and to the AC outlet (p. 19).

Issues Related to Sound

Q Turning the VOLUME knob doesn't change the volume.

A If you're using the DIGITAL OUT, the VOLUME knob will not change the volume. Adjust the "Master Level" (p. 229).

Q There is no sound.

A Check the following points.

- Is the power for connected amps and speakers turned on? Is the volume turned all the way down?
- Is the VOLUME knob turned all the way down?
- Have connections been made correctly?
- Can you hear sound through headphones?

If there is sound in the headphones, it is possible that the connection cables are broken, or that your amp/mixer has malfunctioned. Check your cables and amp/mixer system once again.

- If you do not hear sound when you play the keyboard, check whether the Local Switch is turned OFF.
Make sure that the Local Switch parameter is turned on (p. 229).
- Have all tones in the patch been turned off?
Turn on "Tone Switch."
- The Part level settings may be too low.
Access the Level parameter, and check the level of each part (p. 108).
- Are the Effect settings correct?
Check the Effect settings ON or OFF, the Effect Balance or Level. (p. 206)]
- Are the settings for the output destination correct?
Check the various output assign settings (p. 108).
- Is the Wave Expansion Board properly installed?
When selecting the settings that stipulate the use of EXP-A-D waves, Patches, or Rhythm Sets, check that the specified Wave Expansion Board is installed properly in the specified slot (p. 240, p. 242).

- Has the volume been lowered by pedal operations or by MIDI messages (volume messages or expression messages) received from an external MIDI device?

TIP

In the case of Performance mode, the value of volume messages (Volume) and expression messages (Expression) can be viewed in the Part Information window (p. 106).

- Have the samples been loaded correctly? (p. 201)

Q A specific Part does not sound

A Check the following points.

- Has the volume level of the part been lowered?
Adjust the Level parameter to raise the volume of the part that is not heard (p. 108).
- Is the part being muted?
Set the Mute Switch parameter to "OFF" (p. 107).

Q Specific pitch ranges do not sound

A Has a restricted range of notes been set?

If a specific range of notes does not sound, check the Key Range settings for the Patch Tone, the Performance Part.

- **Tone Key Range**
Key Range Lower/Upper parameter (p. 65)
- **Part Key Range**
Key Range Lower/Upper parameter (p. 111)

Q The sound is distorted.

A Check the following points.

- Is an effect which distorts the sound being applied?
If the sound for a specific patch or part is distorted, lower the volume level on that part.
- If all sounds are distorted, use the VOLUME knob to lower the volume level.
- Could the Output Gain be excessively high?
In "System," check the "Sound" parameter.

Q Pitch is incorrect.

A Check the following points.

- Is the tuning of the Fantom-X incorrect?
Check the Master Tune parameter setting (p. 229).
- Has the pitch been changed by pedal operations or by Pitch Bend messages received from an external MIDI device?

TIP

In the case of Performance mode, the value of Pitch Bend messages (Pitch Bend) can be viewed in the Part Information window (p. 106).

- Have the Coarse Tune or Fine Tune parameters been set for specific Parts?
Check the Coarse Tune parameter and Fine Tune parameter settings (p. 109).

Troubleshooting

Q The sound is interrupted.

A Sounds will be interrupted if more than 128 voices are used simultaneously.

- Reduce the number of Tones that you are using.
- Increase the Voice Reserve setting for parts that must not drop out. (p. 111)

Q When I play the keyboard, notes do not stop.

A Is the pedal polarity of the Hold Pedal reversed?

Check the Hold Pedal Polarity parameter setting (p. 226).

Q When I press a pad, the sound does not stop sounding.

A Could the [HOLD] pad be lit?

Press the [HOLD] pad once again so the light goes out.

Q The sound cuts off when I switch Patches in Patch mode...

A Although you can apply a wide variety of multi-effects with the Fantom-X's multi-effects, switching the Patch also switches the type of multi-effects used.

In such instances, discrepancies between the sound being produced and the multi-effects type can arise, which may result in sounds being different than intended, so sounds produced when Patches are switched may be muted when factory settings are in effect. In certain situations, such as when not using multi-effects that have a great influence on the sound, remembering to set Patch Remain parameter (p. 230) to "ON" allows you to switch Patches without sounds being muted.

Q When switching Patches in Patch mode, the volume and other parameters set with Control Changes end up being reset.

A Set Patch Remain parameter (p. 230) to "ON." Even once they have switched Patches, Control Change messages that have been received are carried forward, so even when switching a Patch whose level is turned all the way down by a Control Change volume message, the level remains unchanged.

Q If the Tone Delay time value is set to the note, then does the delay time not change beyond a fixed length when the tempo is slowed down?

A There is a maximum permissible value for the Delay Time parameter (p. 75). So, if the time setting is specified in terms of a note value, and the tempo is slowed down, this maximum permissible value will be reached, and it cannot be increased further. The upper time limit for each is the maximum value that can be set other than the numerical value for the beat.

Q Even when I set the Pan for a Patch completely to one side, sound still comes from the other channel...

A The Fantom-X's internal effects are in stereo, so if you have effects applied to a Patch, even if the Pan is set all the way to one side, you will still be able to hear sounds of the effect component from the other channel.

Q Sometimes, when playing legato, the pitch won't rise. Why is this?

A When the Legato Switch parameter (p. 77) is "ON," and the Legato Retrigger parameter (p. 77) is "OFF," and you hold down keys in the high register to play legato, the upper pitch limit of the wave may be exceeded, so that the pitch does not rise as far as you expect, but will stop rising at a certain point. Additionally, if differing upper pitch limits are used for the waves of a Patch that uses multiple tones, it may stop being heard in MONO. When making large pitch changes, set the Legato Retrigger parameter to "ON."

Q The notes sound strange in the upper registers of the keyboard.

A Sometimes when playing the keys in the upper part of the Fantom-X's keyboard, the sound may stop, or the pitch may stop rising; or with certain keys, there may be intermittent noise. This occurs mainly when the Fantom-X's upper pitch limit is exceeded, so this issue doesn't arise in the ranges normally used. But, in any case, it does not indicate a malfunction.

Q Although the same Patch is selected, it sounds different when I listen to it in the Performance.

A In Performance mode, the parameters of each part of the performance can apply further modification to parameters such as pan, octave, and filter, relative to the settings specified by the patch. Thus, Patches in a Performance may sound different than they do when heard in Patch mode. To return these settings to their initial conditions, select the Patch after execute Factory Reset Temporary for the Performance. (p. 235)

Additionally, although a Patch may comprise tones created with the use of the multi-effects, the multi-effects used in the Performance may differ from the multi-effects selected by the Patch. Check the multi-effect settings of the performance. Also do the same for the Chorus and Reverb settings.

Q The volume level of the instrument connected to Fantom-X is too low.

A Could you be using a connection cable that contains a resistor? Use a connection cable that does not contain a resistor

Issues Related to Effects

Q Effects not applied.

A Check the following points.

- The “MFX,” “CHO,” “REV” or “MASTER” effect switches located in the upper part of the PLAY screen may have been turned off.
Press [EFFECTS]/[F8 (Effect Sw)] to turn them on.
- Are the various effect settings correct? (p. 206)
- If the send level of each effect is set to 0, the effect will not be applied. Check the settings.
- Even with send levels to each effect set at 0, effects are not applied if the Multi-effects Output Level, the Chorus Level, or the Reverb Level is set to 0. Check each setting.
- If Output Assign is set to other than “MFX,” the Multi-effects sound will not be output.
- If Output Assign is set to “PATCH” for each Part of the Performance, the sound will be output according to the Output Assign settings of the Patch (for each Tone) which is assigned to those Parts. This means that if Output Assign for the Patch (each Tone) is set to other than “MFX,” the Multi-effects sound will not be output.

Q The Modulation or other controller is always on.

A Check the Matrix Controller settings. (p. 80)

The Fantom-X allows you to use the Matrix Control to control Patches in real time. The Matrix Control functions as the control source for the Control Change and other MIDI messages received by the Fantom-X, and makes changes to the various Patch parameters based on these messages.

Depending on these settings, the Fantom-X may be responding to MIDI messages sent from external MIDI devices, and may result the Patches sounding different than intended.

Q Raising the chorus or reverb send level for each part of a performance still does not cause the effect to be applied sufficiently.

A Although you can make Send level settings to the Chorus and Reverb for each individual Part in a Performance, these values only set the upper limit of the Chorus and Reverb Send levels for the Patch used. Accordingly, even when the value is set to the maximum of 127, if the Send level is lowered in the Patch being used, there will be no effect. In addition, different Patch Chorus and Reverb Send level settings can be used according to whether or not the multi-effects are used.

Q Using the Matrix Control or other such means to control the LFO results in noise when the Pan is changed suddenly.

A Lower the change in speed (LFO Rate).

Due to the specialized processing used for the Pan, which alters the volume level in each of the left and right sides, sudden Pan movements causing rapid changes in these levels creates large changes in volume, and noise from this may be audible as a result.

Q Multi-effect 43: TAP DELAY or other delay time value is set to the note, and then the tempo is slowed down, does the delay time not change beyond a fixed length?

A Such Delay time settings have an upper limit, so if the upper limit of a value set to the note is exceeded when the tempo is retarded, that upper value cannot rise any further. The upper time limit for each is the maximum value that can be set other than the numerical value for the beat.

Issues Related to Saving Data

Q The Performance sounds different than when it was written.

A Check the following points.

- If you have modified the settings of a patch used by a performance, or if the temporary patch of the performance has been modified by an external MIDI device, these patches must also be saved.

If patches used by a performance have been edited when you write that performance, the Fantom-X will display a message asking whether you want to discard these patches. In such cases, first save the patch (p. 59) or rhythm set (p. 86), and then save the performance (p. 120) again.

- The Mastering Effect settings may have changed. (These settings are not stored as part of a performance.)

Q Patches sound different than when written.

A Check the following points.

- The write operation cannot be used to save Patches as changed in Patch mode using Control Change messages from an external MIDI device.

cf. →

Refer to **MIDI Implementation** (p. 298) for more on the Control Change messages that are received.

- The Mastering Effect settings may have changed. (These settings are not stored as part of a patch.)

Q The Arpeggio and D Beam controller settings in the Performance are different than those for the Patch.

A Since the Fantom-X stores arpeggio and D Beam controller settings for each performance, it will operate according to the arpeggio and D Beam controller settings that were specified for each performance.

Issues Related to Sequencer

Q Song data does not play back correctly

A Check the following points.

- Has the Receive General MIDI/General MIDI 2 System On Switch been turned ON?

Set the Rx GM System ON/Rx GM2 System ON parameter (SYSTEM/MIDI) to "ON" (p. 231).

- Are you trying to start playback from midway through the song?

The beginning of a GM score song contains a General MIDI/General MIDI 2 System On message. In some cases, a GM Score cannot be played back correctly unless this message is received.

- Are you trying to play song data designed for the GS Format? When the Fantom-X receives a GS Reset message, the Fantom-X is enabled for the GS format. This permits playback of music data bearing the GS logo (GS music data). However, data created exclusively for the Sound Canvas Series may not play back properly on the Fantom-X.

Q After recording, the song does not sound when I play it back.

A Have the tracks been muted?

Defeat muting (p. 107).

Q The tempo is different than the last time I played back the song.

A If a song is played back after the tempo is changed, then the new tempo is not saved unless the song is saved to the user memory or memory card. Conversely, the previous tempo will be erased when you save the song. When saving songs, carefully check the current tempo.

Q Locate Positions set in song have disappeared.

A Check the following points.

- Was the disk saved in a format other than MRC-Pro format (SMF 0 or 1)? Locate positions will be saved with the song data only when saving in MRC-Pro format.
- Are you using Quick Play? In order to use locate positions, the song must be loaded into the Fantom-X.

Q Sound Device Tones Are Switched Arbitrarily

A Use the Microscope (p. 192) to check the following points.

- Has an unneeded program change been input? Or are there duplicate program changes?
- Were any mistakes made in setting the data MIDI channels when Program Change messages were input?

Q Data supposed to be present does not appear in microscope.

A Check the following points.

- Are the wrong tracks selected?
- In View Select (p. 194), is any data set not to be displayed?

Q After using a MIDI sequencer to play a song, sounds stopped playing, and no sound is played even when Program Changes are sent.

A It could be that a Bank Select in the song data that is not specified by the Fantom-X was encountered in the song. No sound is played if the tone group is not one designated by the Fantom-X with Bank Select MSB/LSB. Note that if you omit the Bank Select, and send only the Program Change, the tone in the currently selected group that has the specified Program Change number will play. Try reselecting the tone using the panel controls. Furthermore, when selecting tones from an external MIDI device, be sure to send the Bank Select MSB/LSB and the Program Change as a single set for reliable reproduction. First sending the MSB and LSB (the order in which these are sent does not matter), followed by the Program Change.

cf.

For more about the relationship between the Bank Select MSB/LSB and corresponding tone groups, refer to **<Bank Select and Program Change Correspondence Chart>** (p. 330).

In some cases, you may be unable to hear any sound after playing the last song that was faded-out. This may be because the volume has been lowered by volume messages or expression messages. Check the value of these messages, and set them to appropriate values.

Q Performances are sluggish, or have interruptions.

A Problems of sluggish and interrupted performances can crop up very easily when the sequencer or sound generator used for the performance has to handle heavy data loads. Main causes and possible corrective measures are considered below.

- Are more than 128 voices playing simultaneously? Reduce the number of voices. The composition of Fantom-X Patches is such that up to eight Waves may be used for one Patch. When using such Patches, even though only one sound may be heard, it is actually eight sounds that are being played simultaneously. In addition, with certain sounds like continuous sounds with long releases, even though the actual sound may not be audible to you, processing for playing the sound is still underway, so in these cases as well, the performance data can differ from the actual number of voices being played.

TIP

In the Part Information window you can check the number of notes for which sound is actually being processed (p. 106).

- Are you using a Patch that uses a lot of LFO? Try changing to a different Patch. LFO processing invariably places a big load on the machine, so heavy use of the LFO slows down processing for the Fantom-X overall, which can end up having affecting the expression of sounds themselves.

- Is the data concentrated at the beginning of the beats in the sequence data?
Avoid overlapping data with the same timing by setting an offset of 1–2 clocks instead. Data may easily become concentrated at the beginning of the beats in the song data when, for example, the song data is input using Step Recording, or if the data is quantized after being input with a keyboard in real time. Because of this, large amounts of data are sent to the Fantom-X, and the processing for expressing sounds becomes bogged down.
- Is there a Program Change at the point where the song performance is sluggish?
Change the position of the Program Change. When Program Changes are inserted in songs, processing time for switching patches increases, which may then cause the performance to become sluggish.
- Is there a System Exclusive message at the point where the song performance is sluggish?
Move the location of the data. System Exclusive messages contain large amounts of data, thus placing a heavy burden on sequencers and sound modules. Try repositioning data and changing System Exclusive messages to Control Changes for any data for which Control Changes can be substituted.
- Is there an Aftertouch or other such large Control Change at the point where the song performance is sluggish?
Move the location of the data. If the data is no longer needed, delete the data. In some cases, when using a keyboard that features aftertouch to input data, you may end up inputting huge amounts of data before realizing this is happening. Such large amounts of data can place an excessive load on your sequencer and sound module.

TIP

You can use the Track Edit operation Data Thin (p. 190) to thin out unwanted messages.

Issues Related to MIDI and External Devices

Q No Sound from connected MIDI device.

A Check the following points.

- Is the instrument set to transmit MIDI messages?
- **In Patch Mode**
Kbd Patch Rx/Tx Channel parameter (Keyboard part) (p. 230)
Pad Patch Rx/Tx Channel (Pad part) (p. 230)
- **In Performance Mode**
KBD switch -> Performance Layer, Mixer screen/KBD

Q Exclusive messages are not received.

A Check the following points.

- Is the instrument set to receive Exclusive messages?
Set the Rx Exclusive parameter to “ON” (p. 231).
- Does the Device ID number of the transmitting device match the Device ID number of the Fantom-X?
Check the Device ID parameter (p. 230).
- Are you attempting to write to the User area? Data can be written to the User area only in Librarian mode.

Q I connected an external sequencer or MIDI keyboard to the MIDI IN connector, and attempted to play a Fantom-X rhythm set, but there was no sound. Why?

A Check to make sure that the MIDI Transmit channel of the external MIDI device and the Fantom-X’s MIDI Receive channel are matched. The MIDI Receive channel used by the Fantom-X in Patch mode is set with the Kbd Patch RX/TX Channel parameter (keyboard part) and Pad Patch RX/TX Channel parameter (pad part). Rhythm Set performance data is generally received on MIDI Channel 10.

Q Messages from MIDI IN are not being received.

A Additionally, the MIDI IN connector cannot be used if USB mode (p. 218) is set to MIDI. Set the USB mode to Storage.

Q When using sequencing software, operating the knobs or other controls does not affect the sound.

A For some sequencing programs, System Exclusive messages are not transmitted by the Thru function. If you are using such sequencer software and want to record system exclusive messages, turn on the following parameters.

- **In Patch Mode**
Local Switch parameter (p. 229).
- **In Performance Mode**
KBD switch (p. 101).

Q When the Bend Range for a Patch is increased (48), the pitch does not rise sufficiently, even when a MIDI Pitch Bend message is received.

A While Patch Bend Ranges can be set anywhere between 0 and 48, when certain Waves in which the pitch is raised (in the + direction) are used, the pitch may stop rising at a fixed point, rather than continuing to go up. Although a value of 12 is ensured for the upper limit of raised pitches, use caution when setting the Bend Range above this figure.

Issues Related to Sampling

Q External input sound cannot be heard/volume is too low

A Check the following points.

- Could [MIX IN] be unlit?
Press [MIX IN] so it is lit.
- The level of the external input may be lowered.
When you sample, use the EXT SOURCE "VOLUME" knob to adjust the level appropriately.
- Hold down [SHIFT] and press [MIX IN] to access the Input Setting screen, and check the Level settings.
- The volume of the device connected to AUDIO INPUT may be lowered.
Adjust it to an appropriate level.
- Are the audio cables connected correctly?
Check the connections.
- An audio cable may be broken.
- Could you be using an audio cable with a built-in resistor?
Use a connection cable that does not contain a resistor (e.g., Roland PCS series).

Q External input sound is not stereo/is not monaural

A Check the following points.

- Stereo Switch parameter (p. 143) may be set to monaural (stereo).
- Could the Input Select parameter be set to "LINE IN L," or "Microphone"?
Hold down [SHIFT] and press [MIX IN] to access the Input Setting screen, and set "Input Select" to "LINE IN L/R."

Q Mic sound is not output/is too weak

A Check the following points.

- Is the mic cable connected correctly?
Check the connection.
- The mic cable may be broken.
- The input source may be set to something other than mic.
Hold down [SHIFT] and press [MIX IN] to access the Input Setting screen, and set "Input Select" to "Microphone."
- The mic level may have been lowered.
When sampling, use the EXT SOURCE "LEVEL" knob to adjust the level appropriately.

Q Can't record a sample

A Check the following points.

- Is there enough memory capacity?
If there is insufficient sample memory, a message of "Sample Memory Full!" will appear when you attempt to sample. (p. 147)
Erase unneeded samples to increase the amount of free space.
If there is still not enough, install additional memory (DIMM modules). (p. 244, p. 246)

Q Sampled sound contains excessive noise or distortion

A Check the following points.

- Is the input level appropriate? If the input level is too high, the sampled sound will be distorted. If it is too low, noise will be heard. When sampling, turn the LEVEL knob in the Sampling Standby screen (p. 142) to adjust the level while watching the level meter displayed in the upper part of the display. Adjust the level so that the "CLIP" indication in the upper right of the display does not appear.
- Are the effect settings appropriate?
Some types of effect may increase the level louder than the original sample, or may intentionally distort the sound. Some effects will also cause noise to be emphasized.
Temporarily turn off effects, and check whether the sample itself contains noise or distortion. Then adjust the effect settings appropriately.
- Are multiple samples being played simultaneously?
Even if the level of each individual sample is appropriate, simultaneously playing multiple samples may cause the overall level to be excessively high, causing distortion. Lower the level of each sample so that the sound is not distorted.

Issues Related to a Memory Card

Q Can't select data from a memory card

A Check the following points.

- Is the memory card inserted correctly?
Turn off the power, remove the memory card, then re-insert the memory card correctly.
- Is the memory card an appropriate type?
The Fantom-X can use either PC card type memory cards, or another type of memory card via a PC card adaptor.

Q I can't use a memory card

A Is the memory card formatted?

An unformatted floppy disk cannot be used. Perform the Format procedure.

Parameter List

Patch Parameter

General Group (P.60)

Parameter		Value
Patch Name	* Specify when writing.	space, A-Z, a-z, 0-9, ! " # \$ % & ' () * +, - . / : ; < = > ? @ [\] ^ _ ` { }
Patch Category		
Patch Level		0-127
Patch Pan		L64-0-63R
Patch Priority		LAST, LOUDEST
Octave Shift		-3- +3
Patch Coarse Tune		-48- +48
Patch Fine Tune		-50- +50
Stretch Tune Depth		OFF, 1-3
Analog Feel	Analog Feel Depth	0-127
Cutoff Offset		-63- +63
Resonance Offset		-63- +63
Attack Time Offset		-63- +63
Release Time Offset		-63- +63
Velocity Sens Offset		-63- +63

Wave Group (P.62)

Parameter		Value
Wave Group		INT, EXP, SAMP, MSAM
Wave Bank		When the wave group is INT: A or B, EXP: A-D, When the wave group is SAMP: PRST, USER, CARD, When the wave group is MSAM: USER, CARD
Wave No. L (Mono)	Wave Number L (Mono)	----, 1-1228 (The upper limit will depend on the wave group.)
Wave No. R	Wave Number R	----, 1-1228 (The upper limit will depend on the wave group.)
Wave Gain		-6, 0, +6, +12
Wave Tempo Sync		OFF, ON
FXM Switch		OFF, ON
FXM Color		1-4
FXM Depth		0-16

TMT Group (P.63)

Parameter		Value
Structure Type 1 & 2, 3 & 4		1-10
Booster 1 & 2, 3 & 4	Booster Gain 1 & 2, 3 & 4	0, +6, +12, +18
Key Fade Lower	Keyboard Fade Width Lower	0-127
Key Range Lower	Keyboard Range Lower	C-1-UPPER
Key Range Upper	Keyboard Range Upper	LOWER-G9
Key Fade Upper	Keyboard Fade Width Upper	0-127
TMT Velocity Control	TMT Velocity Control Switch	OFF, ON, RANDOM, CYCLE
Velo Fade Lower	Velocity Fade Width Lower	0-127
Velo Range Lower	Velocity Range Lower	1-UPPER
Velo Range Upper	Velocity Range Upper	LOWER-127
Velo Fade Upper	Velocity Fade Width Upper	0-127
TMT Control Sw	TMT Control Switch	OFF, ON

Parameter List

Pitch Group (P.67)

Parameter		Value
Tone Coarse Tune		-48- +48
Tone Fine Tune		-50- +50
Random Pitch Depth		0, 1, 2, 3, 4, 5, 6, 7, 8, 9, 10, 20, 30, 40, 50, 60, 70, 80, 90, 100, 200, 300, 400, 500, 600, 700, 800, 900, 1000, 1100, 1200
Pitch Key Follow		-200, -190, -180, -170, -160, -150, -140, -130, -120, -110, -100, -90, -80, -70, -60, -50, -40, -30, -20, -10, 0, +10, +20, +30, +40, +50, +60, +70, +80, +90, +100, +110, +120, +130, +140, +150, +160, +170, +180, +190, +200
Bend Range Up	Pitch Bend Range Up	0- +48
Bend Range Down	Pitch Bend Range Down	-48-0
P-Env V-Sens	Pitch Envelope Velocity Sensitivity	-63- +63
P-Env T1 V-Sens	Pitch Envelope Time 1 Velocity Sensitivity	-63- +63
P-Env T4 V-Sens	Pitch Envelope Time 4 Velocity Sensitivity	-63- +63
P-Env Time KF	Pitch Envelope Time Key Follow	-100, -90, -80, -70, -60, -50, -40, -30, -20, -10, 0, +10, +20, +30, +40, +50, +60, +70, +80, +90, +100

Pitch Env Group (P.68)

Parameter		Value
P-Env Depth	Pitch Envelope Depth	-12- +12
P-Env Time1-4	Pitch Envelope Time 1-4	0-127
P-Env Level0-4	Pitch Envelope Level 0-4	-63- +63

TVF Group (P.69)

Parameter		Value
Filter Type		OFF, LPF BPF, HPF, PKG, LPF2, LPF3
Cutoff Frequency		0-127
Resonance		0-127
Cutoff Key Follow	Cutoff Frequency Key follow	-200, -190, -180, -170, -160, -150, -140, -130, -120, -110, -100, -90, -80, -70, -60, -50, -40, -30, -20, -10, 0, +10, +20, +30, +40, +50, +60, +70, +80, +90, +100, +110, +120, +130, +140, +150, +160, +170, +180, +190, +200
Cutoff V-Curve	Cutoff Frequency Velocity Curve	FIXED, 1-7
Cutoff V-Sens	Cutoff Velocity Sensitivity	-63- +63
Resonance V-Sens	Resonance Velocity Sensitivity	-63- +63
F-Env V-Curve	TVF Envelope Velocity Curve	FIXED, 1-7
F-Env V-Sens	TVF Envelope Velocity Sensitivity	-63- +63
F-Env T1 V-Sens	TVF Envelope Time 1 Velocity Sensitivity	-63- +63
F-Env T4 V-Sens	TVF Envelope Time 4 Velocity Sensitivity	-63- +63

TVF Env Group (P.71)

Parameter		Value
F-Env Depth	TVF Envelope Depth	-63- +63
F-Env Time KF	TVF Envelope Time Key Follow	-100, -90, -80, -70, -60, -50, -40, -30, -20, -10, 0, +10, +20, +30, +40, +50, +60, +70, +80, +90, +100
F-Env Time1-4	TVF Envelope Time 1-4	0-127
F-Env Level 0-4	TVF Envelope Level 0-4	0-127

TVA Group (P.71)

Parameter		Value
Tone Level		0-127
Level V-Curve	TVA Level Velocity Curve	FIXED, 1-7
Level V-Sens	TVA Level Velocity Sensitivity	-63- +63
Bias Level		-100, -90, -80, -70, -60, -50, -40, -30, -20, -10, 0, +10, +20, +30, +40, +50, +60, +70, +80, +90, +100
Bias Position		C-1-G9
Bias Direction		LOWER, UPPER, LO&UP, ALL
Tone Pan		L64-0-63R
Pan Key follow		-100- +100
Random Pan Depth		0-63
Alter Pan Depth	Alternate Pan Depth	L63-0-63R

TVA Env Group (P.72)

Parameter		Value
A-Env T1 V-Sens	TVA Envelope Time 1 Velocity Sensitivity	-63- +63
A-Env T4 V-Sens	TVA Envelope Time 4 Velocity Sensitivity	-63- +63
A-Env Time KF	TVA Envelope Time Key Follow	-100, -90, -80, -70, -60, -50, -40, -30, -20, -10, 0, +10, +20, +30, +40, +50, +60, +70, +80, +90, +100
A-Env Time1-4	TVA Envelope Time 1-4	0-127
A-Env Level1-3	TVA Envelope Level 1-3	0-127

Output Group (P.73)

Parameter		Value
Patch Out Assign	Patch Output Assign	MFx, A, B, 1-4, TONE
Tone Out Assign	Tone Output Assign	MFx, A, B, 1-4
Tone Out Level	Tone Output Level	0-127
Tone Chorus Send (Send Level (Output=MFx))	Tone Chorus Send Level	0-127
Tone Reverb Send (Send Level (Output=MFx))	Tone Reverb Send Level	0-127
Tone Chorus Send (Send Level (Output=non MFx))	Tone Chorus Send Level	0-127
Tone Reverb Send (Send Level (Output=non MFx))	Tone Reverb Send Level	0-127

LFO1/2 Group (P.74)

Parameter		Value
Waveform	LFO1/LFO2 Waveform	SIN, TRI, SAW-U, SAW-D, SQR, RND, BND-U, BND-D, TRP S&H, CHAOS, VSIN, STEP
Rate	LFO1/LFO2 Rate	0-127, Note
Rate Detune	LFO1/LFO2 Rate Detune	0-127
Offset	LFO1/LFO2 Offset	-100, -50, 0, +50, +100
Delay Time	LFO1/LFO2 Delay Time	0-127
Delay Time KF	LFO1/LFO2 Delay Time Key Follow	-100, -90, -80, -70, -60, -50, -40, -30, -20, -10, 0, +10, +20, +30, +40, +50, +60, +70, +80, +90, +100
Fade Mode	LFO1/LFO2 Fade Mode	ON <, ON >, OFF <, OFF >
Fade Time	LFO1/LFO2 Fade Time	0-127
Key Trigger	LFO1/LFO2 Key Trigger	OFF, ON
Pitch Depth	LFO1/LFO2 Pitch Depth	-63- +63
TVF Depth	LFO1/LFO2 TVF Depth	-63- +63
TVA Depth	LFO1/LFO2 TVA Depth	-63- +63
Pan Depth	LFO1/LFO2 Pan Depth	-63- +63

Step LFO Group (P.76)

Parameter		Value
Step Type	LFO Step Type	TYPE 1, TYPE 2
Step 1-16	LFO Step1-16	-36- +36

Solo/Porta Group (P.77)

Parameter		Value
Mono (Solo) /Poly		MONO (SOLO), POLY
Legato Switch		OFF, ON
Legato Retrigger	Legato Retrigger Switch	OFF, ON
Portamento Switch		OFF, ON
Portamento Mode		NORMAL, LEGATO
Portamento Type		RATE, TIME
Portamento Start		PITCH, NOTE
Portamento Time		0-127

Parameter List

Misc Group (P.78)

Parameter		Value
Tone Delay Mode		NORM, HOLD, OFF-N, OFF-D
Tone Delay Time		0-127, Note
Tone Env Mode		NO SUS, SUST
Tone Rx Bender	Tone Receive Pitch Bend Switch	OFF, ON
Tone Rx Expression	Tone Receive Expression Switch	OFF, ON
Tone Rx Hold-1	Tone Receive Hold Switch	OFF, ON
Tone Rx Pan Mode	Tone Receive Pan Mode	CONT, K-ON
Tone Redamper Sw	Tone Redamper Switch	OFF, ON

CTRL 1-4 Group (P.81)

Parameter		Value
Matrix Control 1-4 Source		OFF, CC01-31, 33-95, PITCH BEND, AFTERTOUCH, SYS CTRL1-SYS CTRL4, VELOCITY, KEYFOLLOW, TEMPO, LFO1, LFO2, PITCH ENV, TVF ENV, TVA ENV
CTRL Destination 1-4	Matrix Control Destination 1-4	OFF, PITCH, CUTOFF, RESONANCE, LEVEL, PAN, OUTPUT LEVEL, CHORUS SEND, REVERB SEND, LFO1 PITCH DEPTH, LFO2 PITCH DEPTH, LFO1 TVF DEPTH, LFO2 TVF DEPTH, LFO1 TVA DEPTH, LFO2 TVA DEPTH, LFO1 PAN DEPTH, LFO2 PAN DEPTH, LFO1 RATE, LFO2 RATE, PIT ENV A-TIME, PIT ENV D-TIME, PIT ENV R-TIME, TVF ENV A-TIME, TVF ENV D-TIME, TVF ENV R-TIME, TVA ENV A-TIME, TVA ENV D-TIME, TVA ENV R-TIME, TMT, FXM DEPTH, MFX CTRL1, MFX CTRL2, MFX CTRL3, MFX CTRL4, TIME
CTRL Sens 1-4	Matrix Control Sens 1-4	-63- +63
CTRL Switch 1-4	Tone Control Switch 1-4	OFF, ON, REVERSE

Effect Group (P.207)

Parameter		Value
MFX		
Type	Multi-Effects Type	00 THROUGH-78 SYMPATHETIC RESONANCE
MFX Output Level	Multi-Effects Output Level	0-127
MFX Chorus Send Level	Multi-Effects Chorus Send Level	0-127
MFX Reverb Send Level	Multi-Effects Reverb Send Level	0-127
MFX Output Assign	Multi-Effects Output Assign	A, B
Source 1-4	Multi-Effects Control Source 1-4	OFF, CC01-31, 33-95, PITCH BEND, AFTERTOUCH, SYS CTRL1-SYS CTRL4
Destination 1-4	Multi-Effects Control Destination 1-4	
Sens 1-4	Multi-Effects Control Sens 1-4	-63- +63
Chorus		
Chorus Type		0 (Off), 1 (Chorus), 2 (Delay), 3 (GM2 Chorus)
Chorus Output Select		MAIN, REV, M+R
Chorus Level		0-127
Chorus Output Assign		A, B
Reverb		
Reverb Type		0 (Off), 1 (Reverb), 2 (SRV Room), 3 (SRV Hall), 4 (SRV Plate), 5 (GM2 Reverb)
Reverb Level		0-127
Reverb Output Assign		A, B

Rhythm Set Parameter

General Group (P.87)

Parameter		Value
Rhythm Set Name	* Specify when writing.	space, A-Z, a-z, 0-9, ! " # \$ % & ' () * +, - . / : ; < = > ? @ [\] ^ _ ` { }
Rhythm Tone Name		space, A-Z, a-z, 0-9, ! " # \$ % & ' () * +, - . / : ; < = > ? @ [\] ^ _ ` { }
Rhythm Level	Rhythm Set Level	0-127
Assign Type		MULTI, SINGLE
Mute Group		OFF, 1-31
Tone Env Mode	Rhythm Tone Envelope Mode	NO-SUS, SUSTAIN
Tone Pitch Bend Range	Rhythm Tone Pitch Bend Range	0-48
Tone Receive Expression	Rhythm Tone Receive Expression Switch	OFF, ON
Tone Receive Hold-1	Rhythm Tone Receive Hold-1 Switch	OFF, ON
Tone Receive Pan Mode	Rhythm Tone Receive Pan Mode	CONTINUOUS, KEY-ON
One Shot Mode		OFF, ON
Aftertouch Time Ctrl Sens	Aftertouch Time Control Sensitivity	-63- +63

Wave Group (P.88)

Parameter		Value
Wave Group		INT, EXP, SAMP, MSAM
Wave Bank		When the wave group is INT: A or B, EXP: A-D, When the wave group is SAMP: PRST, USER, CARD, When the wave group is MSAM: USER, CARD
Wave No. L (Mono)	Wave Number L (Mono)	----, 1-1228 (The upper limit will depend on the wave group.)
Wave No. R	Wave Number R	----, 1-1228 (The upper limit will depend on the wave group.)
Wave Gain		-6, 0, +6, +12
Wave Tempo Sync		OFF, ON
FXM Switch		OFF, ON
FXM Color		1-4
FXM Depth		0-16

WMT Group (P.89)

Parameter		Value
Wave Coarse Tune		-48- +48
Wave Fine Tune		-50- +50
Wave Level		0-127
Wave Pan		L64-0-63R
Wave Rnd Pan Sw	Wave Random Pan Switch	OFF, ON
Wave Alter Pan Sw	Wave Alternate Pan Switch	OFF, ON, REVS
WMT Velocity Control	Velocity Control Switch	OFF, ON, RANDOM
Velo Fade Lower	Velocity Fade Width Lower	0-127
Velo Range Lower	Velocity Range Lower	1-UPPER
Velo Range Upper	Velocity Range Upper	LOWER-127
Velo Fade Upper	Velocity Fade Width Upper	0-127

Pitch Group (P.91)

Parameter		Value
Tone Coarse Tune	Rhythm Tone Coarse Tune	C-1-G9
Tone Fine Tune	Rhythm Tone Fine Tune	-50- +50
Tone Random Pitch Depth		0, 1, 2, 3, 4, 5, 6, 7, 8, 9, 10, 20, 30, 40, 50, 60, 70, 80, 90, 100, 200, 300, 400, 500, 600, 700, 800, 900, 1000, 1100, 1200

Parameter List

Pitch Env Group (P.91)

Parameter		Value
P-Env Depth	Pitch Envelope Depth	-12- +12
P-Env V-Sens	Pitch Envelope Velocity Sensitivity	-63- +63
P-Env T1 V-Sens	Pitch Envelope Time 1 Velocity Sensitivity	-63- +63
P-Env T4 V-Sens	Pitch Envelope Time 4 Velocity Sensitivity	-63- +63
P-Env Time1-4	Pitch Envelope Time 1-4	0-127
P-Env Level 0-4	Pitch Envelope Level 0-4	-63- +63

TVF Group (P.92)

Parameter		Value
Filter Type		OFF, LPF BPF, HPF, PKG, LPF2, LPF3
Cutoff Frequency		0-127
Resonance		0-127
Cutoff V-Curve	Cutoff Frequency Velocity Curve	FIXED, 1-7
Cutoff V-Sens	Cutoff Velocity Sensitivity	-63- +63
Resonance V-Sens	Resonance Velocity Sensitivity	-63- +63

TVF Env Group (P.93)

Parameter		Value
F-Env Depth	TVF Envelope Depth	-63- +63
F-Env V-Curve	TVF Envelope Velocity Curve	FIX, 1-7
F-Env V-Sens	TVF Envelope Velocity Sensitivity	-63- +63
F-Env T1 V-Sens	TVF Envelope Time 1 Velocity Sensitivity	-63- +63
F-Env T4 V-Sens	TVF Envelope Time 4 Velocity Sensitivity	-63- +63
F-Env Time1-4	TVF Envelope Time 1-4	0-127
F-Env Level0-4	TVF Envelope Level 0-4	0-127

TVA Group (P.94)

Parameter		Value
Tone Level	Rhythm Tone level	0-127
Level V-Curve	Level Velocity Curve	FIXED, 1-7
Level V-Sens	Level Velocity Sensitivity	-63- +63
Tone Pan	Rhythm Tone Pan	L64-0-63R
Random Pan Depth		0-63
Alternate Pan Depth		L63-0-63R

TVA Env Group (P.94)

Parameter		Value
A-Env T1 V-Sens	TVA Envelope Time 1 Velocity Sensitivity	-63- +63
A-Env T4 V-Sens	TVA Envelope Time 4 Velocity Sensitivity	-63- +63
A-Env Time1-4	TVA Envelope Time 1-4	0-127
A-Env Level1-3	TVA Envelope Level 1-3	0-127

Output Group (P.95)

Parameter		Value
Rhythm Out Assign	Rhythm Output Assign	MFX, A, B, 1-4, TONE
Tone Out Assign	Tone Output Assign	MFX, A, B, 1-4
Tone Out Level	Tone Output Level	0-127
Tone Chorus Send (Send Level (Output=MFX))	Tone Chorus Send Level	0-127
Tone Reverb Send (Send Level (Output=MFX))	Tone Reverb Send Level	0-127
Tone Chorus Send (Send Level (Output=non MFX))	Tone Chorus Send Level	0-127
Tone Reverb Send (Send Level (Output=non MFX))	Tone Reverb Send Level	0-127

Effect Group (P.207)

Parameter		Value
MXF		
Type	Multi-Effects Type	00 THROUGH-78 SYMPATHETIC RESONANCE
MXF Output Level	Multi-Effects Output Level	0-127
MXF Chorus Send Level	Multi-Effects Chorus Send Level	0-127
MXF Reverb Send Level	Multi-Effects Reverb Send Level	0-127
MXF Output Assign	Multi-Effects Output Assign	A, B
Source 1-4	Multi-Effects Control Source 1-4	OFF, CC01-31, 33-95, PITCH BEND, AFTERTOUC, SYS CTRL1-SYS CTRL4
Destination 1-4	Multi-Effects Control Destination 1-4	
Sens 1-4	Multi-Effects Control Sens 1-4	-63- +63
Chorus		
Chorus Type		0 (Off), 1 (Chorus), 2 (Delay), 3 (GM2 Chorus)
Chorus Output Select		MAIN, REV, M+R
Chorus Level		0-127
Chorus Output Assign		A, B
Reverb		
Reverb Type		0 (Off), 1 (Reverb), 2 (SRV Room), 3 (SRV Hall), 4 (SRV Plate), 5 (GM2 Reverb)
Reverb Level		0-127
Reverb Output Assign		A, B

Parameter List

Performance Parameter

General Group (P.120)

Parameter	Value
Performance Name	* Specify when writing. space, A-Z, a-z, 0-9, ! " # \$ % & ' () * +, - . / : ; < = > ? @ [\] ^ _ ` { }

Part View Group (P.107)

Parameter	Value
[F1 (Level/Pan)]	
Patch Type	Patch, Rhythm
Patch Bank	USER, PRST, GM, CARD, XP-A-D
Patch Number	001-
Keyboard Switch	OFF, ON
Solo Switch	OFF, ON
Mute Switch	OFF, ON
Part Level	0-127
Part Pan	L64-0-63R
[F2 (Output Effect)]	
Part Output Assign	MFX, A, B, 1-4, PATCH
Part Output MFX Select	1-3 (MFX-1-MFX-3)
Part Output Level	0-127
Part Chorus Send Level	0-127
Part Reverb Send Level	0-127
MFX1-3 Source	OFF, ON
Chorus Source	OFF, ON
Reverb Source	OFF, ON
[F3 (Pitch)]	
Part Octave Shift	-3- +3
Part Coarse Tune	-48- +48
Part Fine Tune	-50- +50
Part Mono/Poly	MONO, POLY, PATCH
Part Legato Switch	OFF, ON, PATCH
Part Pitch Bend Range	0-24, PATCH
Part Portamento Switch	OFF, ON, PATCH
Part Portamento Time	0-127, PATCH
[F4 (Offset)]	
Part Cutoff Offset	-64- +63
Part Resonance Offset	-64- +63
Part Attack Time Offset	-64- +63
Part Release Time Offset	-64- +63
Part Decay Time Offset	-64- +63
[F5 (Key Range)]	
Keyboard Switch	OFF, ON
Keyboard Range Lower	C-1-UPPER
Keyboard Range Upper	LOWER-G9
Part Velocity Sens Offset	-63- +63
Part Vibrato Rate	-64- +63
Part Vibrato Depth	-64- +63
Part Vibrato Delay	-64- +63
Voice Reserve	0-63, FULL
[F6 (Scale Tune)]	
C-B	Part Scale Tune C-B -64- +63
[F7 (External)]	
Receive Switch	OFF, ON
Receive Channel	1-16
External Bank Select MSB	0-127, OFF
External Bank Select LSB	0-127
External Program Number	External Program Change Number 1-128, OFF
External Level	0-127, OFF
External Pan	L64-0-63R, OFF

Parameter		Value
[F8 (MIDI Filter)]		
Program Change	Receive Program Change Switch	OFF, ON
Bank Select	Receive Bank Select Switch	OFF, ON
Pitch Bend	Receive Pitch Bend Switch	OFF, ON
Polyphonic Key Pressure	Receive Polyphonic Key Pressure Switch	OFF, ON
Channel Pressure	Receive Channel Pressure Switch	OFF, ON
Modulation	Receive Modulation Switch	OFF, ON
Volume	Receive Volume Switch	OFF, ON
Pan	Receive Pan Switch	OFF, ON
Expression	Receive Expression Switch	OFF, ON
Hold-1	Receive Hold 1 Switch	OFF, ON
Phase Lock	Phase Lock Switch	OFF, ON
Velocity Curve		OFF, 1-4

Control Setting Group (P.114)

Parameter		Value
Ctrl Switch		
Control Bender	Control Pitch Bend Switch	OFF, ON
Control Aftertouch	Control Aftertouch Switch	OFF, ON
Control Modulation	Control Modulation Switch	OFF, ON
Control Hold Pedal	Control Hold Pedal Switch	OFF, ON
Control Pedal	Control Pedal Switch	OFF, ON
Control D Beam	Control D Beam Switch	OFF, ON
Control Knob 1-4	Control Knob Switch	OFF, ON
D Beam (Pad Trigger)		
Pad Number		1-16
Pad Velocity		1-127
Pad Control Mode		MOMENTARY, LATCH
D Beam (Assignable)		
Type	Assignable Type	CC01-31, 33-95, Bend Up, Bend Down, Start/Stop, Tap Tempo, Arp Grid, Arp Duration, Arp Motif, Arp Octave Up, Arp Octave Down, Arp Step, Aftertouch
Range Min		0-127
Range Max		0-127
Knob		
Knob 1-4 Assign	Realtime Control Knob Assign 1-4	CC01-31, 33-95, Pitch Bend, Aftertouch, Arp Style, Arp Grid, Arp Duration, Arp Motif, Chord Form, Master Level, Arp Step, Digital IN
Switch		
Switch 1/2 Assign	Assignable Switch 1/2	Transpose Down, Transpose Up, Tap Tempo, Mono (Solo) /Poly, Portamento, Hold, MFX1-3 Sw, Chorus Sw, Reverb Sw, Mastering Sw, Loop, Rhythm Start/Stop
Tempo		
Recommended Tempo		20-250
MFX Ctrl Ch		
MFX1-3 Control Channel		1-16, OFF

Pad Setting Group (P.161)

Parameter		Value
Note	Pad Note	C-1-G9
Velocity	Pad Velocity	COMMON, 1-127
Pad Common Velo		
Pad Common Velo	Pad Common Velocity	REAL, 1-127
Pad Sens	Pad Sensitivity	LIGHT, MEDIUM, HEAVY
Aftertouch Sens	Aftertouch Sensitivity	1-100
Roll Resolution		1/4 (♩), 1/6 (♩ ₃), 1/8 (♩), 1/12 (♩ ₃), 1/16 (♩), 1/24 (♩ ₃), 1/32 (♩), 1/48 (♩ ₃)
Quick Setup		
Template Set		Note, Rhythm, Multi Velo
Base Note	Pad Base Note	C-1-G9

Parameter List

Arpeggio Group (P.128)

Parameter		Value
Arp Switch	Arpeggio Switch	OFF, ON
Arp Grid	Arpeggio Grid	1/4 (♩), 1/8 (♩), 1/8 (♩) L, 1/8 (♩) H, 1/12 (♩ ₃), 1/16 (♩), 1/16 (♩) L, 1/16 (♩) H, 1/24 (♩ ₃)
Arp Duration	Arpeggio Duration	30, 40, 50, 60, 70, 80, 90, 100, 120, FULL
Arpeggio Switch		OFF, ON
Arpeggio Hold		OFF, ON
Arpeggio Style		U001–U128, P001–P128
Arpeggio Motif		Up (L), Up (L&H), Up (⏏), Down (L), Down (L&H), Down (⏏), Up&Down, Up&Down (L&H), Up&Down (⏏), Random (L), Random (⏏), Phrase
Arpeggio Velocity		REAL, 1–127
Arpeggio Part		1–16
Arpeggio Octave Range		-3– +3
Arpeggio Accent Rate		0–100

Rhythm Group (P.135)

Parameter		Value
Rhy Switch	Rhythm Switch	OFF, ON
Rhythm Pattern Grid		1/4 (♩), 1/8 (♩), 1/8 (♩) L, 1/8 (♩) H, 1/12 (♩ ₃), 1/16 (♩), 1/16 (♩) L, 1/16 (♩) H, 1/24 (♩ ₃)
Rhythm Pattern Duration		30, 40, 50, 60, 70, 80, 90, 100, 120, FULL
Rhythm Pattern Switch		OFF, ON
Rhythm Pattern Velocity		REAL, 1–127
Rhythm Pattern Accent Rate		0–100
Rhythm Group Number		U01–U32, P01–P32

Chord Memory Group (P.133)

Parameter		Value
Chord Switch		OFF, ON
Chord Form		U01–U64, P01–P64
Rolled Chord Switch		OFF, ON
Rolled Chord Type		UP, DOWN, ALTERNATE

Effect Group (P.210)

Parameter		Value
MFX		
Structure Type		1–16
MFX Type	Multi-Effects Type	0–78
MFX Output Level	Multi-Effects Output Level	0–127
MFX Chorus Send Level	Multi-Effects Chorus Send Level	0–127
MFX Reverb Send Level	Multi-Effects Reverb Send Level	0–127
MFX Output Assign	Multi-Effects Output Assign	A, B
Source 1–4	Multi-Effects Control Source 1–4	OFF, CC01–31, 33–95, PITCH BEND, AFTERTOUCH, SYS CTRL1–SYS CTRL4
Destination 1–4	Multi-Effects Control Destination 1–4	
Sens 1–4	Multi-Effects Control Sens 1–4	-63– +63
MFX Control Channel	Multi-Effects Control Channel	1–16, OFF
MFX-1–3 Source	Multi-Effects 1–3 Source	PRF, P1–P16
Chorus		
Chorus Type		0 (Off), 1 (Chorus), 2 (Delay), 3 (GM2 Chorus)
Chorus Output Select		MAIN, REV, MAIN+REV
Chorus Level		0–127
Chorus Output Assign		A, B
Chorus Source		PRF, P1–P16
Reverb		
Reverb Type		0 (Off), 1 (Reverb) 2 (SRV Room), 3 (SRV Hall) 4 (SRV Plate), 5 (GM2 Reverb)
Reverb Level		0–127
Reverb Output Assign		A, B
Reverb Source		PRF, P1–P16

Rhythm Group Parameter

Rhythm Group Group (P.139)

Parameter		Value
Recommended Rhy	Recommended Rhythm Set	USER, PRST, GM, CARD, XP-A-D
Pad Mode		OFF, NOTE, PATTERN
Rhy Ptn Number	Rhythm Pattern Number	U001-U256, P001-P256
Rhy Ptn Velocity	Rhythm Pattern Velocity	REAL, 1-127
Pad Note		C-1-G9
Pad Velocity		REAL, 1-127

Sample Parameters

Sample Group (P.150)

Parameter		Value
Sample Name		space, A-Z, a-z, 0-9, ! " # \$ % & ' () * + , - . / : ; < = > ? @ [\] ^ _ ` { }
Loop Mode		FWD, ONE-SHOT, REV, REV-ONE
Loop Tune		-50- +50
Original Key		0 (C-1) -127 (G9)
BPM	tempo	5.00-300.00
Time Stretch Type		TYPE01-TYPE10
Start Fine		0-255
Loop Start Fine		0-255
Loop End Fine		0-255

Parameter List

System Parameters

Pedal/D Beam Group (P.226)

Parameter		Value
D Beam Sens	D Beam Sensitivity	0-127
Control Pedal Assign		CC01-31, 33-95, BEND-UP, BEND-DOWN, AFTERTOUCH, OCT UP, OCT DOWN, START/STOP, PUNCH IN/OUT, TAP TEMPO, PROG UP, PROG DOWN, FAVORITE UP, FAVORITE DOWN, ARP / RHY SW, RHY START/STOP, CHORD SW, LIVE SET UP, LIVE SET DOWN, LOOP
Control Pedal Polarity		STANDARD, REVERSE
Hold Pedal Polarity		STANDARD, REVERSE
Continuous Hold Pedal		OFF, ON

Keyboard Group (P.226)

Parameter		Value
Keyboard Velocity		REAL, 1-127
Keyboard Sens	Keyboard Sensitivity	LIGHT, MEDIUM, HEAVY
Aftersens Sens	Aftersens Sensitivity	0-100

Sync/Tempo Group (P.227)

Parameter		Value
Sync Mode		MASTER, SLAVE-MIDI, SLAVE-MTC, REMOTE
Sync Output	Sync Output switch	OFF, ON
Tempo Override		OFF, ON
Arp/Rhythm Sync Switch	Arpeggio/Rhythm Sync Switch	OFF, ON
MMC Mode		MASTER, SLAVE
MMC Output	MMC Output switch	OFF, ON
MTC Sync Output	MTC Sync Output switch	OFF, ON
MTC Frame Rate		24, 25, 29N, 29D, 30
MTC Offset Time Hour		0-23 hours
MTC Offset Time Minute		0-59 minutes
MTC Offset Time Second		0-59 seconds
MTC Offset Time Frame		0-29 frames
MTC Error Level		0-10

Metronome Group (P.228)

Parameter		Value
Metronome Mode		OFF, PLAY-ONLY, REC-ONLY, PLAY&REC, ALWAYS
Metronome Level		0-10
Metronome Sound		TYPE 1, TYPE 2, TYPE 3, TYPE 4
Beat Indicator Mode		REC&PLAY, ALWAYS

Sound (P.229)

Parameter		Value
Local Switch		OFF, ON
Master Tune		415.3-466.2 Hz
Master Level		0-127
Output Gain		-12- +12 dB
Mix/Parallel		MIX, PARALLEL
Master Key Shift		-24- +24
Patch Remain	Patch Remain Switch	OFF, ON

MIDI Group (P.230)

Parameter		Value
Device ID	Device ID Number	17-32
Performance Control Channel		1-16, OFF
Kbd Patch Rx/Tx Ch	Keyboard Patch Receive/Transmit Channel	1-16
Pad Patch Rx/Tx Ch	Pad Patch Receive/Transmit Channel	1-16
Transmit Program Change	Transmit Program Change Switch	OFF, ON
Transmit Bank Select	Transmit Bank Select Switch	OFF, ON
Transmit Active Sensing	Transmit Active Sensing Switch	OFF, ON
Transmit Edit Data	Transmit Edit Data Switch	OFF, ON
Soft Through	Soft Through Switch	OFF, ON
Remote Keyboard Sw	Remote Keyboard Switch	OFF, ON
Receive Program Change	Receive Program Change Switch	OFF, ON
Receive Bank Select	Receive Bank Select Switch	OFF, ON
Receive Exclusive	Receive System Exclusive Switch	OFF, ON
Receive GM System On	Receive GM System On Switch	OFF, ON
Receive GM2 System On	Receive GM2 System On Switch	OFF, ON
Receive GS Reset	Receive GS Reset Switch	OFF, ON

USB (P.231)

Parameter		Value
USB Mode		MIDI, STORAGE
USB-MIDI Thru		OFF, ON

Scale Tune Group (P.232)

Parameter		Value
Scale Tune Switch		OFF, ON
Patch Scale Tune for C-B		-64+ +63

Preview Group (P.232)

Parameter		Value
Preview Mode		SINGLE, CHORD, PHRASE
Preview 1-4 Note Number		C-1-G9
Preview 1-4 Velocity		OFF, 1-127

System Ctrl Group (P.233)

Parameter		Value
Sys Ctrl 1-4 Source	System Control1-4 Source	OFF, CC01-31, 33-95, BEND, AFT

Background Group (P.233)

Parameter		Value
Background Picture		1-16

Screen Saver Group (P.233)

Parameter		Value
Screen Saver Type		1-16
Screen Saver Time		OFF, 5-60 min

Sampling Group (P.233)

Parameter		Value
Default File Type		WAV, AIFF
Pre Sample Time		0-1000 ms
Trigger Level		0-7
Gap Time		500, 1000, 1500, 2000 ms
Input Select		DIGITAL LINE-L-R, LINE-L, MIC
Trimming Switch		OFF, ON
Skip Back Time		5s-40s

Parameter List

Startup Group (P.234)

Parameter	Value
Load Preset Samples at Startup	OFF, ON
Load User Samples at Startup	OFF, ON
Load Demo Song at Startup	OFF, ON
Rec Track Select	Manual, Auto
Power Up Mode	PATCH, PERFORMANCE

System Information Group (P.234)

Parameter	Value
Features	Displays the main features of the Fantom-X.
Memory Info	Memory Information
SRX Info	SRX Information
Version Info	Version Information

D Beam (Solo Synth) Group (P.123)

Parameter	Value
OSC1/2 Waveform	SAW, SQR
OSC1/2 Pulse Width	0-127
OSC1/2 Coarse Tune	-48- +48
OSC1/2 Fine Tune	-50- +50
OSC2 Level	0-127
OSC Sync Switch	OFF, ON
Filter Type	OFF, LPF, BPF, HPF, PKG
Cutoff	0-127
Resonance	0-127
Level	0-127
Chorus Send Level	0-127
Reverb Send Level	0-127
LFO Rate	0-127
LFO Osc 1 Pitch Depth	-63- +63
LFO Osc 2 Pitch Depth	-63- +63
LFO Osc 1 Pulse Width Depth	-63- +63
LFO Osc 2 Pulse Width Depth	-63- +63
Range	Solo Synth Range 2 OCTAVE, 4 OCTAVE, 8 OCTAVE

Mastering Effect Group (P.217)

Parameter	Value
HIGH/MID/LOW ATTACK	0-100 ms
HIGH/MID/LOW RELEASE	50-5000 ms
HIGH/MID/LOW THRESHOLD	-36-0 dB
HIGH/MID/LOW RATIO	1.00:1-INF:1 (INF: Infinity)
HIGH/MID/LOW LEVEL	0-24 dB
Split Frequency High	2000-8000 Hz
Split Frequency Low	200-800 Hz

Input Setting Group (P.141)

Parameter	Value
Input Select	DIGITAL IN, LINE IN L/R, LINE IN L, MICROPHONE
Mix-In	ON, OFF
Mix In Output Assign	DRY, MFX
Mix In Output Level	0-127
Mix In Chorus Send Level	0-127
Mix In Reverb Send Level	0-127
Input Effect Switch	ON, OFF
Input Effect Type	EQ, ENHANCER, COMP, LIMITER, NOISE SUP, C CANCELER

V-LINK Group (P.239)

Parameter		Value
Note Tx Ch	Note Transmit Channel	1-16
Clip 1 Note No.	Clip 1 Note Number	0 (C-1)-127 (G9)
Play Speed Ctrl	Play Speed Control	0.0-1.0-2.0, 0.5-1.0-2.0, 0.0-1.0-4.0, 0.5-1.0-4.0, 0.0-1.0-8.0, 0.5-1.0-8.0, 0.0-1.0-16.0, 0.5-1.0-16.0, 0.0-1.0-32.0, 0.5-1.0-32.0, 0.0-2.0-4.0, 0.0-4.0-8.0, 0.0 8.0-16.0, 0.0-16.0-32.0, -2.0-1.0-4.0, -6.0-1.0-8.0
Dissolve Time		OFF, CC1, CC5, CC7, CC10, CC11, CC71-74, CC91-93, Channel Aftertouch
Ctrl Tx Ch	Control Transmit Channel	1-16
Color Cb Ctrl	Color Cb Control	OFF, CC1, CC5, CC7, CC10, CC11, CC71-74, CC91-93, Channel Aftertouch
Color Cr Ctrl	Color Cr Control	OFF, CC1, CC5, CC7, CC10, CC11, CC71-74, CC91-93, Channel Aftertouch
Brightness Ctrl	Brightness Control	OFF, CC1, CC5, CC7, CC10, CC11, CC71-74, CC91-93, Channel Aftertouch
VFX Ctrl	VFX Control	OFF, CC1, CC5, CC7, CC10, CC11, CC71-74, CC91-93, Channel Aftertouch
PAD MODE		CLIP, PALETT
Local Sw	Local Switch	OFF, ON
CLIP FILTER 1-32		OFF, ON

D Beam (Assignable) Group (P.50)

* If Patch mode is selected, this is saved as part of the system settings.

Parameter		Value
Type	Assignable Type	CC01-31, 33-95, Bend Up, Bend Down, Start/Stop, Tap Tempo, Arp Grid, Arp Duration, Arp Motif, Arp Octave Up, Arp Octave Down
Range Min		0-127
Range Max		0-127

Knob Group (P.51)

* If Patch mode is selected, this is saved as part of the system settings.

Parameter		Value
Knob 1-4 Assign	Realtime Control Knob Assign 1-4	CC01-31, 33-95, Pitch Bend, Aftertouch, Arp Style, Arp Grid, Arp Duration, Arp Motif, Chord Form, Master Level

Switch Group (P.51)

* If Patch mode is selected, this is saved as part of the system settings.

Parameter		Value
Switch 1/2 Assign	Assignable Switch 1/2	Transpose Down, Transpose Up, Tap Tempo, Mono (Solo)/Poly, Portamento, Hold, MFX1-3 Sw, Chorus Sw, Reverb Sw, Mastering Sw, Loop, Rhythm Start/Stop

Pad Setting Group (P.161)

Parameter		Value
Pad Common Velo	Pad Common Velocity	REAL, 1-127
Pad Sens	Pad Sensitivity	LIGHT, MEDIUM, HEAVY
Aftertouch Sens	Aftertouch Sensitivity	0-100
Roll Resolution		1/4 (♩), 1/6 (♩ ₃), 1/8 (♩), 1/12 (♩ ₃), 1/16 (♩), 1/24 (♩ ₃), 1/32 (♩), 1/48 (♩ ₃)

* If Patch mode is selected, this is saved as part of the system settings.

Parameter		Value
Pad Set		User, Note, Rhythm
Base	Pad Base Note	C-1-G9
Note	Pad Note	C-1-G9
Velocity	Pad Velocity	REAL, 1-127

Effects List

Multi-Effects Parameter

The multi-effects feature 78 different kinds of effects. Some of the effects consist of two or more different effects connected in series. Parameters marked with a sharp “#” can be controlled using a specified controller (Two setting items will change simultaneously for “#1” and “#2”).

FILTER (10 types)		
01	EQUALIZER	P.271
02	SPECTRUM	P.271
03	ISOLATOR	P.271
04	LOW BOOST	P.271
05	SUPER FILTER	P.272
06	STEP FILTER	P.272
07	ENHANCER	P.272
08	AUTO WAH	P.273
09	HUMANIZER	P.273
10	SPEAKER SIMULATOR	P.273
MODULATION (12 types)		
11	PHASER	P.274
12	STEP PHASER	P.274
13	MULTI STAGE PHASER	P.274
14	INFINITE PHASER	P.274
15	RING MODULATOR	P.275
16	STEP RING MODULATOR	P.275
17	TREMOLO	P.275
18	AUTO PAN	P.275
19	STEP PAN	P.275
20	SLICER	P.276
21	ROTARY	P.276
22	VK ROTARY	P.276
CHORUS (12 types)		
23	CHORUS	P.277
24	FLANGER	P.277
25	STEP FLANGER	P.277
26	HEXA-CHORUS	P.278
27	TREMOLO CHORUS	P.278
28	SPACE-D	P.278
29	3D CHORUS	P.278
30	3D FLANGER	P.279
31	3D STEP FLANGER	P.279
32	2BAND CHORUS	P.279
33	2BAND FLANGER	P.280
34	2BAND STEP FLANGER	P.280
DYNAMICS (8 types)		
35	OVERDRIVE	P.281
36	DISTORTION	P.281
37	VS OVERDRIVE	P.281
38	VS DISTORTION	P.281
39	GUITAR AMP SIMULATOR	P.281
40	COMPRESSOR	P.282
41	LIMITER	P.282
42	GATE	P.282
DELAY (13 types)		
43	DELAY	P.282
44	LONG DELAY	P.283
45	SERIAL DELAY	P.283
46	MODULATION DELAY	P.283
47	3TAP PAN DELAY	P.284
48	4TAP PAN DELAY	P.284
49	MULTI TAP DELAY	P.284
50	REVERSE DELAY	P.284
51	SHUFFLE DELAY	P.285

52	3D DELAY	P.285
53	TIME CTRL DELAY	P.285
54	LONG TIME CTRL DELAY	P.286
55	TAPE ECHO	P.286
LO-FI (5 types)		
56	LOFI NOISE	P.286
57	LOFI COMPRESS	P.287
58	LOFI RADIO	P.287
59	TELEPHONE	P.287
60	PHONOGRAPH	P.287
PITCH (3 types)		
61	PITCH SHIFTER	P.288
62	2VOICE PITCH SHIFTER	P.288
63	STEP PITCH SHIFTER	P.288
REVERB (2 types)		
64	REVERB	P.288
65	GATED REVERB	P.289
COMBINATION (12 types)		
66	OVERDRIVE → CHORUS	P.289
67	OVERDRIVE → FLANGER	P.289
68	OVERDRIVE → DELAY	P.290
69	DISTORTION → CHORUS	P.290
70	DISTORTION → FLANGER	P.290
71	DISTORTION → DELAY	P.290
72	ENHANCER → CHORUS	P.290
73	ENHANCER → FLANGER	P.290
74	ENHANCER → DELAY	P.291
75	CHORUS → DELAY	P.291
76	FLANGER → DELAY	P.291
77	CHORUS → FLANGER	P.292
PIANO (1 type)		
78	SYMPATHETIC RESONANCE	P.292

About Note

Some effect parameters (such as Rate or Delay Time) can be set in terms of a note value.

Such parameters have a num/note switch that lets you specify whether you will set the value as a note value or as a numerical value.

If you want to set Rate (Delay Time) as a numerical value, set the num/note switch to “Hz” (“msec”). If you want to set it as a note value, set the num/note switch to “NOTE.”

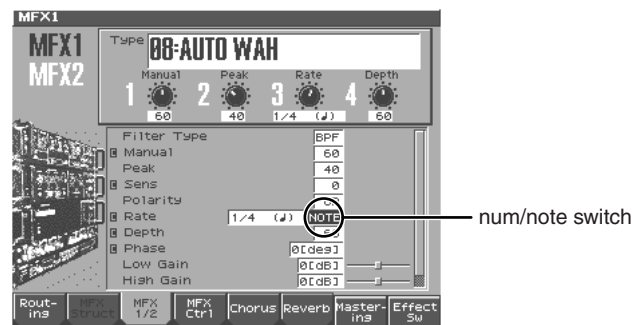

NOTE

If a parameter whose num/note switch is set to “NOTE” is specified as a destination for multi-effect control, you will not be able to use multi-effect control to control that parameter.

01: EQUALIZER

This is a four-band stereo equalizer (low, mid x 2, high).

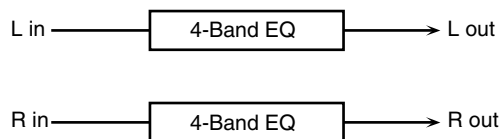

Parameter	Value	Description
Low Freq	200, 400 Hz	Frequency of the low range
Low Gain #	-15- +15 dB	Gain of the low range
Mid1 Freq	200-8000 Hz	Frequency of the middle range 1
Mid1 Gain	-15- +15 dB	Gain of the middle range 1
Mid1 Q	0.5, 1.0, 2.0, 4.0, 8.0	Width of the middle range 1 Set a higher value for Q to narrow the range to be affected.
Mid2 Freq	200-8000 Hz	Frequency of the middle range 2
Mid2 Gain	-15- +15 dB	Gain of the middle range 2
Mid2 Q	0.5, 1.0, 2.0, 4.0, 8.0	Width of the middle range 2 Set a higher value for Q to narrow the range to be affected.
High Freq	2000, 4000, 8000 Hz	Frequency of the high range
High Gain #	-15- +15 dB	Gain of the high range
Level #	0-127	Output Level

02: SPECTRUM

This is a stereo spectrum. Spectrum is a type of filter which modifies the timbre by boosting or cutting the level at specific frequencies.

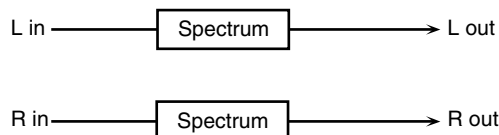

Parameter	Value	Description
Band1 (250Hz)	-15- +15 dB	Gain of each frequency band
Band2 (500Hz)		
Band3 (1000Hz)		
Band4 (1250Hz)		
Band5 (2000Hz)		
Band6 (3150Hz)		
Band7 (4000Hz)		
Band8 (8000Hz)		
Q	0.5, 1.0, 2.0, 4.0, 8.0	Simultaneously adjusts the width of the adjusted ranges for all the frequency bands.
Level #	0-127	Output Level

03: ISOLATOR

This is an equalizer which cuts the volume greatly, allowing you to add a special effect to the sound by cutting the volume in varying ranges.

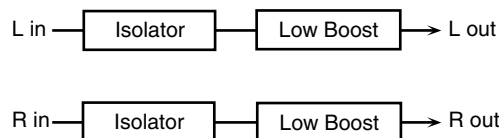

Parameter	Value	Description
Boost/Cut Low #	-60- +4 dB	These boost and cut each of the High, Middle, and Low frequency ranges. At -60 dB, the sound becomes inaudible. 0 dB is equivalent to the input level of the sound.
Boost/Cut Mid #		
Boost/Cut High #		
Anti Phase Low Sw	OFF, ON	Turns the Anti-Phase function on and off for the Low frequency ranges. When turned on, the counter-channel of stereo sound is inverted and added to the signal.
Anti Phase Low Level	0-127	Adjusts the level settings for the Low frequency ranges. Adjusting this level for certain frequencies allows you to lend emphasis to specific parts. (This is effective only for stereo source.)
Anti Phase Mid Sw	OFF, ON	Settings of the Anti-Phase function for the Middle frequency ranges The parameters are the same as for the Low frequency ranges.
Anti Phase Mid Level	0-127	
Low Boost Sw	OFF, ON	Turns Low Booster on/off. This emphasizes the bottom to create a heavy bass sound.
Low Boost Level	0-127	Increasing this value gives you a heavier low end. * Depending on the Isolator and filter settings this effect may be hard to distinguish.
Level	0-127	Output Level

04: LOW BOOST

Boosts the volume of the lower range, creating powerful lows.

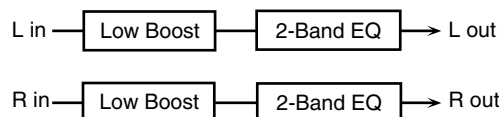

Parameter	Value	Description
Boost Frequency #	50-125 Hz	Center frequency at which the lower range will be boosted
Boost Gain #	0- +12 dB	Amount by which the lower range will be boosted
Boost Width	WIDE, MID, NARROW	Width of the lower range that will be boosted
Low Gain	-15- +15 dB	Gain of the low frequency range
High Gain	-15- +15 dB	Gain of the high frequency range
Level	0-127	Output level

Effects List

05: SUPER FILTER

This is a filter with an extremely sharp slope. The cutoff frequency can be varied cyclically.

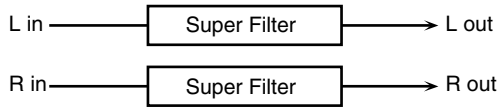

Parameter	Value	Description
Filter Type	LPF, BPF, HPF, NOTCH	Filter type Frequency range that will pass through each filter LPF : frequencies below the cutoff BPF : frequencies in the region of the cutoff HPF : frequencies above the cutoff NOTCH : frequencies other than the region of the cutoff
Filter Slope	-12, -24, -36 dB	Amount of attenuation per octave -36 dB : extremely steep -24 dB : steep -12 dB : gentle
Filter Cutoff #	0-127	Cutoff frequency of the filter Increasing this value will raise the cutoff frequency.
Filter Resonance #	0-127	Filter resonance level Increasing this value will emphasize the region near the cutoff frequency.
Filter Gain	0- +12 dB	Amount of boost for the filter output
Modulation Sw	OFF, ON	On/off switch for cyclic change
Modulation Wave	TRI, SQR, SIN, SAW1, SAW2	How the cutoff frequency will be modulated TRI : triangle wave SQR : square wave SIN : sine wave SAW1 : sawtooth wave (upward) SAW2 : sawtooth wave (downward)
Rate #	0.05-10.00 Hz, note	Rate of modulation
Depth	0-127	Depth of modulation
Attack #	0-127	Speed at which the cutoff frequency will change This is effective if Modulation Wave is SQR, SAW1, or SAW2.
Level	0-127	Output level

06: STEP FILTER

This is a filter whose cutoff frequency can be modulated in steps. You can specify the pattern by which the cutoff frequency will change.

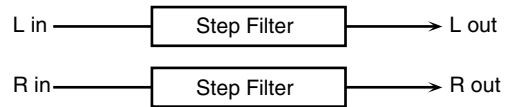

Parameter	Value	Description
Step 01-16	0-127	Cutoff frequency at each step
Rate #	0.05-10.00 Hz, note	Rate of modulation
Attack #	0-127	Speed at which the cutoff frequency changes between steps
Filter Type	LPF, BPF, HPF, NOTCH	Filter type Frequency range that will pass through each filter LPF : frequencies below the cutoff BPF : frequencies in the region of the cutoff HPF : frequencies above the cutoff NOTCH : frequencies other than the region of the cutoff
Filter Slope	-12, -24, -36 dB	Amount of attenuation per octave -12 dB : gentle -24 dB : steep -36 dB : extremely steep
Filter Resonance #	0-127	Filter resonance level Increasing this value will emphasize the region near the cutoff frequency.
Filter Gain	0- +12 dB	Amount of boost for the filter output
Level	0-127	Output level

07: ENHANCER

Controls the overtone structure of the high frequencies, adding sparkle and tightness to the sound.

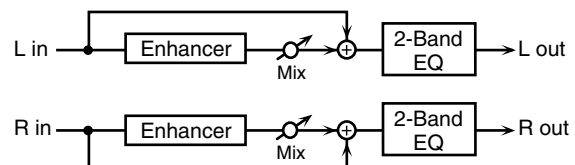

Parameter	Value	Description
Sens #	0-127	Sensitivity of the enhancer
Mix #	0-127	Level of the overtones generated by the enhancer
Low Gain	-15- +15 dB	Gain of the low range
High Gain	-15- +15 dB	Gain of the high range
Level	0-127	Output Level

08: AUTO WAH

Cyclically controls a filter to create cyclic change in timbre.

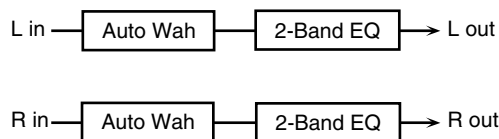

Parameter	Value	Description
Filter Type	LPF, BPF	Type of filter LPF: The wah effect will be applied over a wide frequency range. BPF: The wah effect will be applied over a narrow frequency range.
Manual #	0-127	Adjusts the center frequency at which the effect is controlled.
Peak	0-127	Adjusts the amount of the wah effect that will occur in the range of the center frequency. Set a higher value for Q to narrow the range to be affected.
Sens #	0-127	Adjusts the sensitivity with which the filter is controlled.
Polarity	UP, DOWN	Sets the direction in which the frequency will change when the auto-wah filter is modulated. UP: The filter will change toward a higher frequency. DOWN: The filter will change toward a lower frequency.
Rate #	0.05-10.00 Hz, note	Frequency of modulation
Depth #	0-127	Depth of modulation
Phase #	0-180 deg	Adjusts the degree of phase shift of the left and right sounds when the wah effect is applied.
Low Gain	-15- +15 dB	Gain of the low range
High Gain	-15- +15 dB	Gain of the high range
Level	0-127	Output Level

09: HUMANIZER

Adds a vowel character to the sound, making it similar to a human voice.

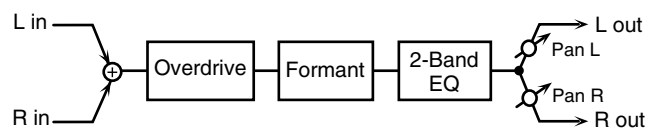

Parameter	Value	Description
Drive Sw	OFF, ON	Turns Drive on/off.
Drive #	0-127	Degree of distortion Also changes the volume.
Vowel1	a, e, i, o, u	Selects the vowel.
Vowel2	a, e, i, o, u	
Rate #	0.05-10.00 Hz, note	Frequency at which the two vowels switch
Depth #	0-127	Effect depth
Input Sync Sw	OFF, ON	Determines whether the LFO for switching the vowels is reset by the input signal (ON) or not (OFF).
Input Sync Threshold	0-127	Volume level at which reset is applied
Manual #	0-100	Point at which Vowel 1/2 switch 49 or less: Vowel 1 will have a longer duration. 50: Vowel 1 and 2 will be of equal duration. 51 or more: Vowel 2 will have a longer duration.
Low Gain	-15- +15 dB	Gain of the low frequency range
High Gain	-15- +15 dB	Gain of the high frequency range
Pan #	L64-63R	Stereo location of the output
Level	0-127	Output level

10: SPEAKER SIMULATOR

Simulates the speaker type and mic settings used to record the speaker sound.

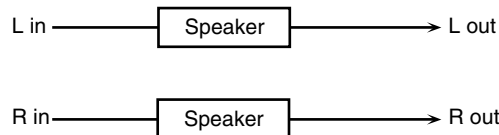

Parameter	Value	Description
Speaker Type	(See the table right.)	Type of speaker
Mic Setting	1, 2, 3	Adjusts the location of the mic that is recording the sound of the speaker. This can be adjusted in three steps, with the mic becoming more distant in the order of 1, 2, and 3.
Mic Level #	0-127	Volume of the microphone
Direct Level #	0-127	Volume of the direct sound
Level #	0-127	Output Level

Specifications of each Speaker Type

The speaker column indicates the diameter of each speaker unit (in inches) and the number of units.

Type	Cabinet	Speaker	Micro- phone
SMALL 1	small open-back enclosure	10	dynamic
SMALL 2	small open-back enclosure	10	dynamic
MIDDLE	open back enclosure	12 x 1	dynamic
JC-120	open back enclosure	12 x 2	dynamic
BUILT-IN 1	open back enclosure	12 x 2	dynamic
BUILT-IN 2	open back enclosure	12 x 2	condenser
BUILT-IN 3	open back enclosure	12 x 2	condenser
BUILT-IN 4	open back enclosure	12 x 2	condenser
BUILT-IN 5	open back enclosure	12 x 2	condenser
BG STACK 1	sealed enclosure	12 x 2	condenser
BG STACK 2	large sealed enclosure	12 x 2	condenser
MS STACK 1	large sealed enclosure	12 x 4	condenser
MS STACK 2	large sealed enclosure	12 x 4	condenser
METAL STACK	large double stack	12 x 4	condenser
2-STACK	large double stack	12 x 4	condenser
3-STACK	large triple stack	12 x 4	condenser

11: PHASER

A phase-shifted sound is added to the original sound and modulated.

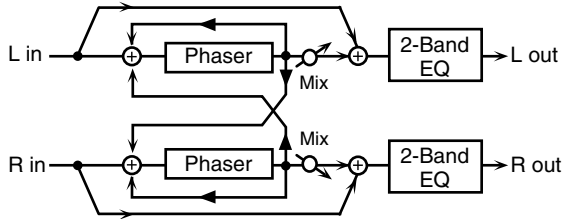

Parameter	Value	Description
Mode	4-STAGE, 8-STAGE, 12-STAGE	Number of stages in the phaser
Manual #	0-127	Adjusts the basic frequency from which the sound will be modulated.
Rate #	0.05-10.00Hz, note	Frequency of modulation
Depth	0-127	Depth of modulation
Polarity	INVERSE, SYNCHRO	Selects whether the left and right phase of the modulation will be the same or the opposite. INVERSE: The left and right phase will be opposite. When using a mono source, this spreads the sound. SYNCHRO: The left and right phase will be the same. Select this when inputting a stereo source.
Resonance #	0-127	Amount of feedback
Cross Feedback	-98- +98 %	Adjusts the proportion of the phaser sound that is fed back into the effect. Negative (-) settings will invert the phase.
Mix #	0-127	Level of the phase-shifted sound
Low Gain	-15- +15 dB	Gain of the low range
High Gain	-15- +15 dB	Gain of the high range
Level	0-127	Output Level

12: STEP PHASER

The phaser effect will be varied gradually.

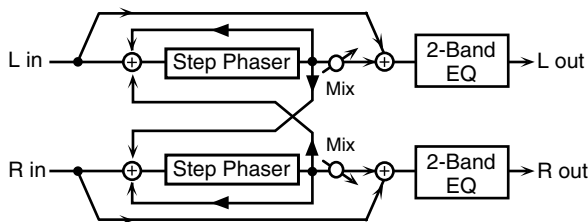

Parameter	Value	Description
Mode	4-STAGE, 8-STAGE, 12-STAGE	Number of stages in the phaser
Manual #	0-127	Adjusts the basic frequency from which the sound will be modulated.
Rate #	0.05-10.00Hz, note	Frequency of modulation
Depth	0-127	Depth of modulation
Polarity	INVERSE, SYNCHRO	Selects whether the left and right phase of the modulation will be the same or the opposite. INVERSE: The left and right phase will be opposite. When using a mono source, this spreads the sound. SYNCHRO: The left and right phase will be the same. Select this when inputting a stereo source.
Resonance #	0-127	Amount of feedback

Parameter	Value	Description
Cross Feedback	-98- +98 %	Adjusts the proportion of the phaser sound that is fed back into the effect. Negative (-) settings will invert the phase.
Step Rate #	0.10-20.00 Hz, note	Rate of the step-wise change in the phaser effect
Mix #	0-127	Level of the phase-shifted sound
Low Gain	-15- +15 dB	Gain of the low range
High Gain	-15- +15 dB	Gain of the high range
Level	0-127	Output Level

13: MULTI STAGE PHASER

Extremely high settings of the phase difference produce a deep phaser effect.

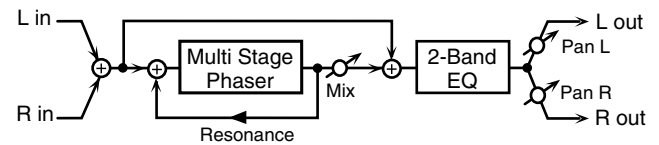

Parameter	Value	Description
Mode	4-STAGE, 8-STAGE, 12-STAGE, 16-STAGE, 20-STAGE, 24-STAGE	Number of phaser stages
Manual #	0-127	Adjusts the basic frequency from which the sound will be modulated.
Rate #	0.05-10.00 Hz, note	Frequency of modulation
Depth	0-127	Depth of modulation
Resonance #	0-127	Amount of feedback
Mix #	0-127	Level of the phase-shifted sound
Pan #	L64-63R	Stereo location of the output sound
Low Gain	-15- +15 dB	Gain of the low range
High Gain	-15- +15 dB	Gain of the high range
Level	0-127	Output Level

14: INFINITE PHASER

A phaser that continues raising/lowering the frequency at which the sound is modulated.

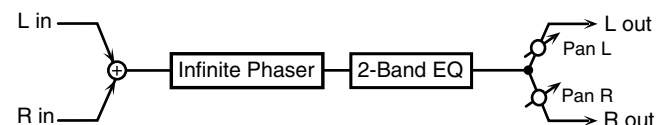

Parameter	Range	Explanation
Mode	1, 2, 3, 4	Higher values will produce a deeper phaser effect.
Speed #	-100- +100	Speed at which to raise or lower the frequency at which the sound is modulated (+: upward / -: downward)
Resonance #	0-127	Amount of feedback
Mix #	0-127	Volume of the phase-shifted sound
Pan #	L64-63R	Panning of the output sound
Low Gain	-15- +15 dB	Amount of boost/cut for the low-frequency range
High Gain	-15- +15 dB	Amount of boost/cut for the high-frequency range
Level	0-127	Output volume

15: RING MODULATOR

This is an effect that applies amplitude modulation (AM) to the input signal, producing bell-like sounds. You can also change the modulation frequency in response to changes in the volume of the sound sent into the effect.

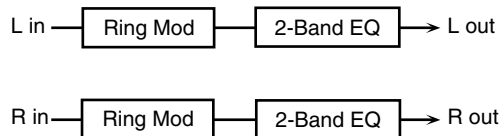

Parameter	Value	Description
Frequency #	0-127	Adjusts the frequency at which modulation is applied.
Sens #	0-127	Adjusts the amount of frequency modulation applied.
Polarity	UP, DOWN	Determines whether the frequency modulation moves towards higher frequencies (UP) or lower frequencies (DOWN).
Low Gain	-15- +15 dB	Gain of the low frequency range
High Gain	-15- +15 dB	Gain of the high frequency range
Balance #	D100:0W- D0:100W	Volume balance between the direct sound (D) and the effect sound (W)
Level	0-127	Output level

16: STEP RING MODULATOR

This is a ring modulator that uses a 16-step sequence to vary the frequency at which modulation is applied.

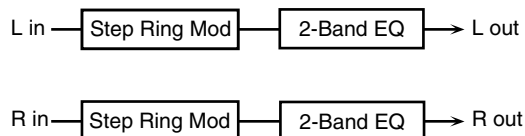

Parameter	Range	Explanation
Step 01-16	0-127	Frequency of ring modulation at each step
Rate #	0.05-10.00 Hz, note	Rate at which the 16-step sequence will cycle
Attack #	0-127	Speed at which the modulation frequency changes between steps
Low Gain	-15- +15 dB	Amount of boost/cut for the low-frequency range
High Gain	-15- +15 dB	Amount of boost/cut for the high-frequency range
Balance #	D100:0W- D0:100W	Volume balance of the original sound (D) and effect sound (W)
Level	0-127	Output volume

17: TREMOLO

Cyclically modulates the volume to add tremolo effect to the sound.

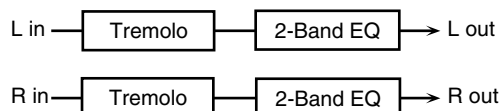

Parameter	Value	Description
Mod Wave	TRI, SQR, SIN, SAW1, SAW2	Modulation Wave TRI : triangle wave SQR : square wave SIN : sine wave SAW1/2 : sawtooth wave
Rate #	0.05-10.00 Hz, note	Frequency of the change
Depth #	0-127	Depth to which the effect is applied
Low Gain	-15- +15 dB	Gain of the low range
High Gain	-15- +15 dB	Gain of the high range
Level	0-127	Output Level



18: AUTO PAN

Cyclically modulates the stereo location of the sound.

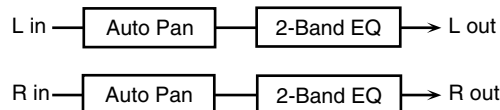

Parameter	Value	Description
Mod Wave	TRI, SQR, SIN, SAW1, SAW2	Modulation Wave TRI : triangle wave SQR : square wave SIN : sine wave SAW1/2 : sawtooth wave
Rate #	0.05-10.00 Hz, note	Frequency of the change
Depth #	0-127	Depth to which the effect is applied
Low Gain	-15- +15 dB	Gain of the low range
High Gain	-15- +15 dB	Gain of the high range
Level	0-127	Output Level

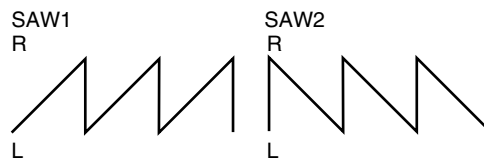

19: STEP PAN

This uses a 16-step sequence to vary the panning of the sound.

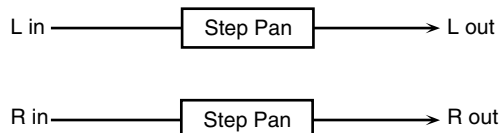

Parameter	Range	Explanation
Step 01-16	L64-63R	Pan at each step
Rate #	0.05-10.00 Hz, note	Rate at which the 16-step sequence will cycle
Attack #	0-127	Speed at which the pan changes between steps
Input Sync Sw	OFF, ON	Specifies whether an input note will cause the sequence to resume from the first step of the sequence (ON) or not (OFF)
Input Sync Threshold	0-127	Volume at which an input note will be detected
Level	0-127	Output volume

Effects List

20: SLICER

By applying successive cuts to the sound, this effect turns a conventional sound into a sound that appears to be played as a backing phrase. This is especially effective when applied to sustain-type sounds.

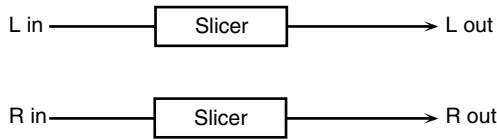

Parameter	Value	Description
Step 01–16	L64–63R	Level at each step
Rate #	0.05–10.00 Hz, note	Rate at which the 16-step sequence will cycle
Attack #	0–127	Speed at which the level changes between steps
Input Sync Sw	OFF, ON	Specifies whether an input note will cause the sequence to resume from the first step of the sequence (ON) or not (OFF)
Input Sync Threshold	0–127	Volume at which an input note will be detected
Mode	LEGATO, SLASH	Sets the manner in which the volume changes as one step progresses to the next. LEGATO: The change in volume from one step's level to the next remains unaltered. If the level of a following step is the same as the one preceding it, there is no change in volume. SLASH: The level is momentarily set to 0 before progressing to the level of the next step. This change in volume occurs even if the level of the following step is the same as the preceding step.
Shuffle #	0–127	Timing of volume changes in levels for even-numbered steps (step 2, step 4, step 6...). The higher the value, the later the beat progresses.
Level	0–127	Output level

21: ROTARY

The Rotary effect simulates the sound of the rotary speakers often used with the electric organs of the past. Since the movement of the high range and low range rotors can be set independently, the unique type of modulation characteristic of these speakers can be simulated quite closely. This effect is most suitable for electric organ Patches.

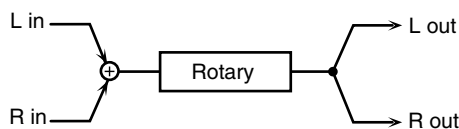

Parameter	Value	Description
Speed #	SLOW, FAST	Simultaneously switch the rotational speed of the low frequency rotor and high frequency rotor. SLOW: Slows down the rotation to the Slow Rate. FAST: Speeds up the rotation to the Fast Rate.
Woofers Slow Speed	0.05–10.00 Hz	Slow speed (SLOW) of the low frequency rotor
Woofers Fast Speed	0.05–10.00 Hz	Fast speed (FAST) of the low frequency rotor

Parameter	Value	Description
Woofers Acceleration	0–15	Adjusts the time it takes the low frequency rotor to reach the newly selected speed when switching from fast to slow (or slow to fast) speed. Lower values will require longer times.
Woofers Level	0–127	Volume of the low frequency rotor
Tweeters Slow Speed	0.05–10.00 Hz	Settings of the high frequency rotor The parameters are the same as for the low frequency rotor
Tweeters Fast Speed	0.05–10.00 Hz	
Tweeters Acceleration	0–15	
Tweeters Level	0–127	
Separation	0–127	Spatial dispersion of the sound
Level #	0–127	Output Level

22: VK ROTARY

This type provides modified response for the rotary speaker, with the low end boosted further.

This effect features the same specifications as the VK-7's built-in rotary speaker.

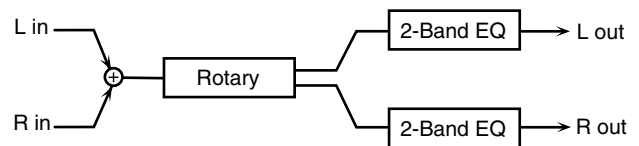

Parameter	Value	Description
Speed #	SLOW, FAST	Rotational speed of the rotating speaker
Brake #	OFF, ON	Switches the rotation of the rotary speaker. When this is turned on, the rotation will gradually stop. When it is turned off, the rotation will gradually resume.
Woofers Slow Speed	0.05–10.00 Hz	Low-speed rotation speed of the woofer
Woofers Fast Speed	0.05–10.00 Hz	High-speed rotation speed of the woofer
Woofers Trans Up	0–127	Adjusts the rate at which the woofer rotation speeds up when the rotation is switched from Slow to Fast.
Woofers Trans Down	0–127	Adjusts the rate at which the woofer rotation speeds up when the rotation is switched from Fast to Slow.
Woofers Level	0–127	Volume of the woofer
Tweeters Slow Speed	0.05–10.00 Hz	Settings of the tweeter The parameters are the same as for the woofer.
Tweeters Fast Speed	0.05–10.00 Hz	
Tweeters Trans Up	0–127	
Tweeters Trans Down	0–127	
Tweeters Level	0–127	
Spread	0–10	Sets the rotary speaker stereo image. The higher the value set, the wider the sound is spread out.
Low Gain	-15– +15 dB	Gain of the low range
High Gain	-15– +15 dB	Gain of the high range
Level #	0–127	Output Level

23: CHORUS

This is a stereo chorus. A filter is provided so that you can adjust the timbre of the chorus sound.

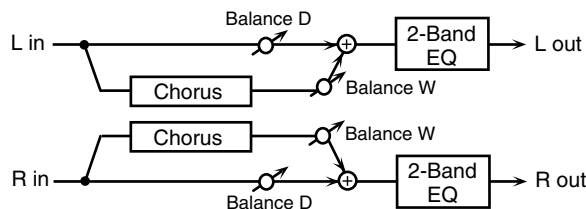

Parameter	Value	Description
Filter Type	OFF, LPF, HPF	Type of filter OFF : no filter is used LPF : cuts the frequency range above the Cutoff Freq HPF : cuts the frequency range below the Cutoff Freq
Cutoff Freq	200–8000 Hz	Basic frequency of the filter
Pre Delay	0.0–100.0 ms	Adjusts the delay time from the direct sound until the chorus sound is heard.
Rate #	0.05–10.00 Hz, note	Frequency of modulation
Depth	0–127	Depth of modulation
Phase	0–180 deg	Spatial spread of the sound
Low Gain	-15– +15 dB	Gain of the low range
High Gain	-15– +15 dB	Gain of the high range
Balance #	D100:0W– D0:100W	Volume balance between the direct sound (D) and the chorus sound (W)
Level	0–127	Output Level

24: FLANGER

This is a stereo flanger. (The LFO has the same phase for left and right.) It produces a metallic resonance that rises and falls like a jet airplane taking off or landing. A filter is provided so that you can adjust the timbre of the flanged sound.

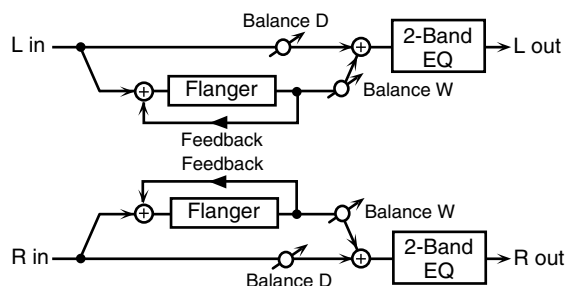

Parameter	Value	Description
Filter Type	OFF, LPF, HPF	Type of filter OFF : no filter is used LPF : cuts the frequency range above the Cutoff Freq HPF : cuts the frequency range below the Cutoff Freq
Cutoff Freq	200–8000 Hz	Basic frequency of the filter
Pre Delay	0.0–100.0 ms	Adjusts the delay time from when the direct sound begins until the flanger sound is heard.
Rate #	0.05–10.00 Hz, note	Frequency of modulation
Depth	0–127	Depth of modulation
Phase	0–180 deg	Spatial spread of the sound
Feedback #	-98– +98 %	Adjusts the proportion of the flanger sound that is fed back into the effect. Negative (-) settings will invert the phase.
Low Gain	-15– +15 dB	Gain of the low range

Parameter	Value	Description
High Gain	-15– +15 dB	Gain of the high range
Balance #	D100:0W– D0:100W	Volume balance between the direct sound (D) and the flanger sound (W)
Level	0–127	Output Level

25: STEP FLANGER

This is a flanger in which the flanger pitch changes in steps. The speed at which the pitch changes can also be specified in terms of a note-value of a specified tempo.

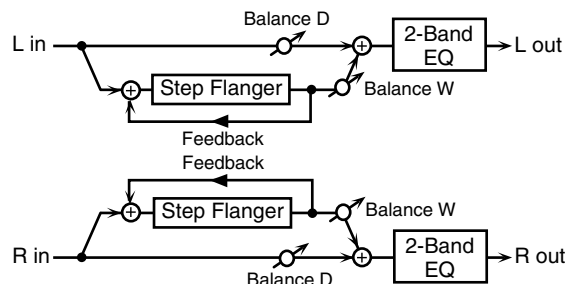

Parameter	Value	Description
Filter Type	OFF, LPF, HPF	Type of filter OFF : no filter is used LPF : cuts the frequency range above the Cutoff Freq HPF : cuts the frequency range below the Cutoff Freq
Cutoff Freq	200–8000 Hz	Basic frequency of the filter
Pre Delay	0.0–100.0 ms	Adjusts the delay time from when the direct sound begins until the flanger sound is heard.
Rate #	0.05–10.00 Hz, note	Frequency of modulation
Depth	0–127	Depth of modulation
Phase	0–180 deg	Spatial spread of the sound
Feedback #	-98– +98 %	Adjusts the proportion of the flanger sound that is fed back into the effect. Negative (-) settings will invert the phase.
Step Rate #	0.10–20.00 Hz, note	Rate (period) of pitch change
Low Gain	-15– +15 dB	Gain of the low range
High Gain	-15– +15 dB	Gain of the high range
Balance #	D100:0W–D0:100W	Volume balance between the direct sound (D) and the flanger sound (W)
Level	0–127	Output Level

Effects List

26: HEXA-CHORUS

Uses a six-phase chorus (six layers of chorused sound) to give richness and spatial spread to the sound.

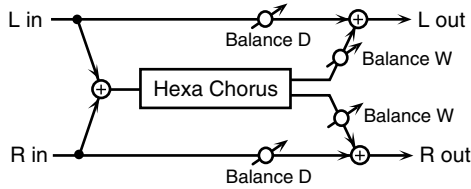

Parameter	Value	Description
Pre Delay	0.0–100.0 ms	Adjusts the delay time from the direct sound until the chorus sound is heard.
Rate #	0.05–10.00 Hz, note	Frequency of modulation
Depth	0–127	Depth of modulation
Pre Delay Deviation	0–20	Adjusts the differences in Pre Delay between each chorus sound.
Depth Deviation	-20– +20	Adjusts the difference in modulation depth between each chorus sound.
Pan Deviation	0–20	Adjusts the difference in stereo location between each chorus sound. 0: All chorus sounds will be in the center. 20: Each chorus sound will be spaced at 60 degree intervals relative to the center.
Balance #	D100:0W–D0:100W	Volume balance between the direct sound (D) and the chorus sound (W)
Level	0–127	Output Level

27: TREMOLO CHORUS

This is a chorus effect with added Tremolo (cyclic modulation of volume).

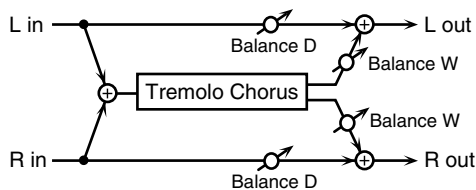

Parameter	Value	Description
Pre Delay	0.0–100.0 ms	Adjusts the delay time from the direct sound until the chorus sound is heard.
Chorus Rate #	0.05–10.00 Hz, note	Modulation frequency of the chorus effect
Chorus Depth	0–127	Modulation depth of the chorus effect
Tremolo Rate #	0.05–10.00 Hz, note	Modulation frequency of the tremolo effect
Tremolo Separation	0–127	Spread of the tremolo effect
Tremolo Phase	0–180 deg	Spread of the tremolo effect
Balance #	D100:0W–D0:100W	Volume balance between the direct sound (D) and the tremolo chorus sound (W)
Level	0–127	Output Level

28: SPACE-D

This is a multiple chorus that applies two-phase modulation in stereo. It gives no impression of modulation, but produces a transparent chorus effect.

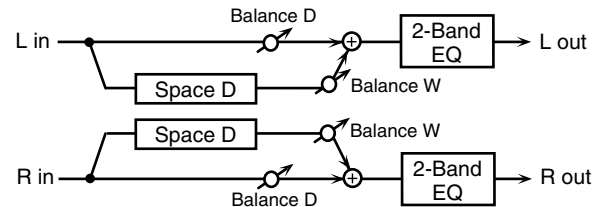

Parameter	Value	Description
Pre Delay	0.0–100.0 ms	Adjusts the delay time from the direct sound until the chorus sound is heard.
Rate #	0.05–10.00 Hz, note	Frequency of modulation
Depth	0–127	Depth of modulation
Phase	0–180 deg	Spatial spread of the sound
Low Gain	-15– +15 dB	Gain of the low range
High Gain	-15– +15 dB	Gain of the high range
Balance #	D100:0W–D0:100W	Volume balance between the direct sound (D) and the chorus sound (W)
Level	0–127	Output Level

29: 3D CHORUS

This applies a 3D effect to the chorus sound. The chorus sound will be positioned 90 degrees left and 90 degrees right.

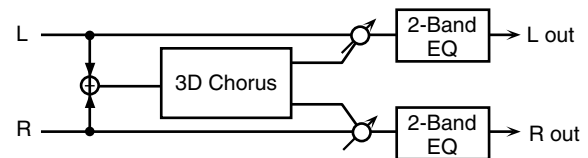

Parameter	Value	Description
Filter Type	OFF, LPF, HPF	Type of filter OFF: no filter is used LPF: cuts the frequency range above the Cutoff Freq HPF: cuts the frequency range below the Cutoff Freq
Cutoff Freq	200–8000 Hz	Basic frequency of the filter
Pre Delay	0.0–100.0 ms	Adjusts the delay time from the direct sound until the chorus sound is heard.
Rate #	0.05–10.00 Hz, note	Frequency of modulation
Depth	0–127	Modulation depth of the chorus effect
Phase	0–180 deg	Spatial spread of the sound
Output Mode	SPEAKER, PHONES	Adjusts the method that will be used to hear the sound that is output to the OUTPUT jacks. The optimal 3D effect will be achieved if you select SPEAKER when using speakers, or PHONES when using headphones.
Low Gain	-15– +15 dB	Gain of the low range
High Gain	-15– +15 dB	Gain of the high range
Balance #	D100:0W–D0:100W	Volume balance between the direct sound (D) and the chorus sound (W)
Level	0–127	Output Level

30: 3D FLANGER

This applies a 3D effect to the flanger sound. The flanger sound will be positioned 90 degrees left and 90 degrees right.

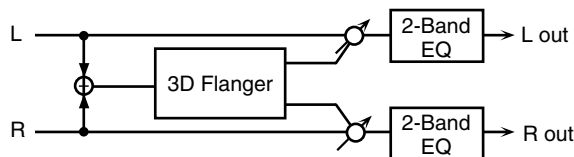

Parameter	Value	Description
Filter Type	OFF, LPF, HPF	Type of filter OFF: no filter is used LPF: cuts the frequency range above the Cutoff Freq HPF: cuts the frequency range below the Cutoff Freq
Cutoff Freq	200–8000 Hz	Basic frequency of the filter
Pre Delay	0.0–100.0 ms	Adjusts the delay time from when the direct sound begins until the flanger sound is heard.
Rate #	0.05–10.00 Hz, note	Frequency of modulation
Depth	0–127	Depth of modulation
Phase	0–180 deg	Spatial spread of the sound
Feedback #	-98– +98 %	Adjusts the proportion of the flanger sound that is fed back into the effect. Negative (-) settings will invert the phase.
Output Mode	SPEAKER, PHONES	Adjusts the method that will be used to hear the sound that is output to the OUTPUT jacks. The optimal 3D effect will be achieved if you select SPEAKER when using speakers, or PHONES when using headphones.
Low Gain	-15– +15 dB	Gain of the low range
High Gain	-15– +15 dB	Gain of the high range
Balance #	D100:0W–D0:100W	Volume balance between the direct sound (D) and the flanger sound (W)
Level	0–127	Output Level

31: 3D STEP FLANGER

This applies a 3D effect to the step flanger sound. The flanger sound will be positioned 90 degrees left and 90 degrees right.

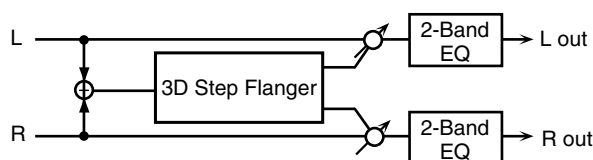

Parameter	Value	Description
Filter Type	OFF, LPF, HPF	Type of filter OFF: no filter is used LPF: cuts the frequency range above the Cutoff Freq HPF: cuts the frequency range below the Cutoff Freq
Cutoff Freq	200–8000 Hz	Basic frequency of the filter
Pre Delay	0.0–100.0 ms	Adjusts the delay time from when the direct sound begins until the flanger sound is heard.
Rate #	0.05–10.00 Hz, note	Frequency of modulation
Depth	0–127	Depth of modulation
Phase	0–180 deg	Spatial spread of the sound

Parameter	Value	Description
Feedback #	-98– +98 %	Adjusts the proportion of the flanger sound that is fed back into the effect. Negative (-) settings will invert the phase.
Step Rate #	0.10–20.00 Hz, note	Rate (period) of pitch change
Output Mode	SPEAKER, PHONES	Adjusts the method that will be used to hear the sound that is output to the OUTPUT jacks. The optimal 3D effect will be achieved if you select SPEAKER when using speakers, or PHONES when using headphones.
Low Gain	-15– +15 dB	Gain of the low range
High Gain	-15– +15 dB	Gain of the high range
Balance #	D100:0W–D0:100W	Volume balance between the direct sound (D) and the flanger sound (W)
Level	0–127	Output Level

32: 2BAND CHORUS

A chorus effect that lets you apply an effect independently to the low-frequency and high-frequency ranges.

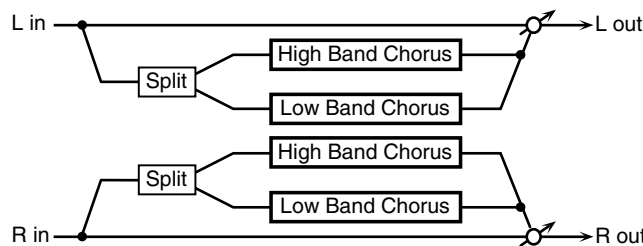

Parameter	Range	Explanation
Split Freq	200–8000 Hz	Frequency at which the low and high ranges will be divided
Low Pre Delay	0.0–100.0 ms	Delay time from when the original sound is heard to when the low-range chorus sound is heard
Low Rate #	0.05–10.00 Hz, note	Rate at which the low-range chorus sound is modulated
Low Depth	0–127	Modulation depth for the low-range chorus sound
Low Phase	0–180 deg	Spaciousness of the low-range chorus sound
High Pre Delay	0.0–100.0 ms	Delay time from when the original sound is heard to when the high-range chorus sound is heard
High Rate #	0.05–10.00 Hz, note	Rate at which the low-range chorus sound is modulated
High Depth	0–127	Modulation depth for the high-range chorus sound
High Phase	0–180 deg	Spaciousness of the high-range chorus sound
Balance #	D100:0W–D0:100W	Volume balance of the original sound (D) and chorus sound (W)
Level	0–127	Output volume

33: 2BAND FLANGER

A flanger that lets you apply an effect independently to the low-frequency and high-frequency ranges.

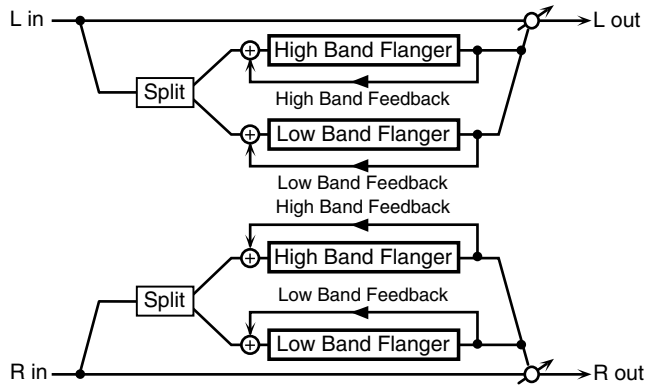

Parameter	Range	Explanation
Split Freq	200–8000 Hz	Frequency at which the low and high ranges will be divided
Low Pre Delay	0.0–100.0 ms	Delay time from when the original sound is heard to when the low-range flanger sound is heard
Low Rate #	0.05–10.00 Hz, note	Rate at which the low-range flanger sound is modulated
Low Depth	0–127	Modulation depth for the low-range flanger sound
Low Phase	0–180 deg	Spaciousness of the low-range flanger sound
Low Feedback #	-98– +98%	Proportion of the low-range flanger sound that is to be returned to the input (negative values invert the phase)
High Pre Delay	0.0–100.0 ms	Delay time from when the original sound is heard to when the high-range flanger sound is heard
High Rate #	0.05–10.00 Hz, note	Rate at which the high-range flanger sound is modulated
High Depth	0–127	Modulation depth for the high-range flanger sound
High Phase	0–180 deg	Spaciousness of the high-range flanger sound
High Feedback #	-98– +98%	Proportion of the high-range flanger sound that is to be returned to the input (negative values invert the phase)
Balance #	D100:0W–D0:100W	Volume balance of the original sound (D) and flanger sound (W)
Level	0–127	Output volume

34: 2BAND STEP FLANGER

A step flanger that lets you apply an effect independently to the low-frequency and high-frequency ranges.

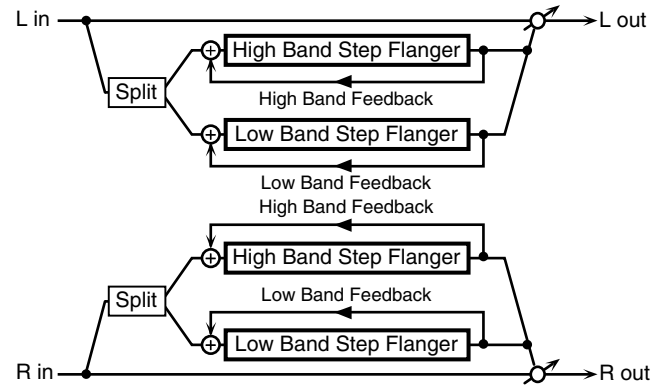

Parameter	Range	Explanation
Split Freq	200–8000 Hz	Frequency at which the low and high ranges will be divided
Low Pre Delay	0.0–100.0 ms	Delay time from when the original sound is heard to when the low-range flanger sound is heard
Low Rate #	0.05–10.00 Hz, note	Rate at which the low-range flanger sound is modulated
Low Depth	0–127	Modulation depth for the low-range flanger sound
Low Phase	0–180 deg	Spaciousness of the low-range flanger sound
Low Feedback #	-98– +98%	Proportion of the low-range flanger sound that is to be returned to the input (negative values invert the phase)
Low Step Rate #	0.10–20.00 Hz, note	Rate at which the steps will cycle for the low-range flanger sound
High Pre Delay	0.0–100.0 ms	Delay time from when the original sound is heard to when the high-range flanger sound is heard
High Rate #	0.05–10.00 Hz, note	Rate at which the high-range flanger sound is modulated
High Depth	0–127	Modulation depth for the high-range flanger sound
High Phase	0–180 deg	Spaciousness of the high-range flanger sound
High Feedback #	-98– +98%	Proportion of the high-range flanger sound that is to be returned to the input (negative values invert the phase)
High Step Rate #	0.10–20.00 Hz, note	Rate at which the steps will cycle for the high-range flanger sound
Balance #	D100:0W–D0:100W	Volume balance of the original sound (D) and flanger sound (W)
Level	0–127	Output volume

35: OVERDRIVE

Creates a soft distortion similar to that produced by vacuum tube amplifiers.

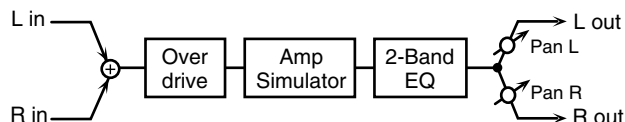

Parameter	Value	Description
Drive #	0-127	Degree of distortion Also changes the volume.
Amp Type	SMALL, BUILT-IN, 2-STACK, 3-STACK	Type of guitar amp SMALL: small amp BUILT-IN: single-unit type amp 2-STACK: large double stack amp 3-STACK: large triple stack amp
Low Gain	-15- +15 dB	Gain of the low range
High Gain	-15- +15 dB	Gain of the high range
Pan #	L64-63R	Stereo location of the output sound
Level	0-127	Output Level

36: DISTORTION

Produces a more intense distortion than Overdrive. The parameters are the same as for "35: OVERDRIVE."

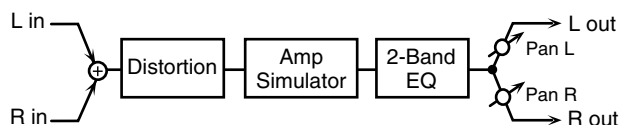

37: VS OVERDRIVE

This is an overdrive that provides heavy distortion.

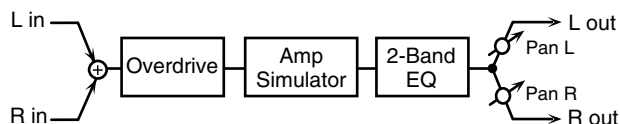

Parameter	Value	Description
Drive #	0-127	Degree of distortion Also changes the volume.
Tone #	0-127	Sound quality of the Overdrive effect
Amp Sw	OFF, ON	Turns the Amp Simulator on/off.
Amp Type	SMALL, BUILT-IN, 2-STACK, 3-STACK	Type of guitar amp SMALL: small amp BUILT-IN: single-unit type amp 2-STACK: large double stack amp 3-STACK: large triple stack amp
Low Gain	-15- +15 dB	Gain of the low range
High Gain	-15- +15 dB	Gain of the high range
Pan #	L64-63R	Stereo location of the output sound
Level	0-127	Output Level

38: VS DISTORTION

This is a distortion effect that provides heavy distortion. The parameters are the same as for "37: VS OVERDRIVE."

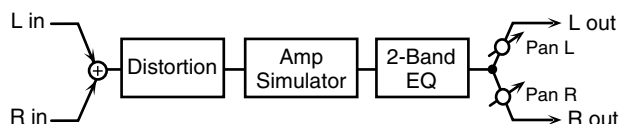

39: GUITAR AMP SIMULATOR

This is an effect that simulates the sound of a guitar amplifier.

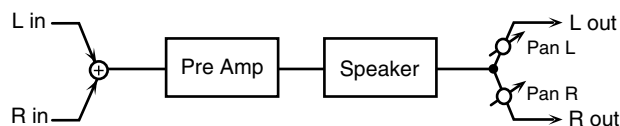

Parameter	Value	Description
Pre Amp Sw	OFF, ON	Turns the amp switch on/off.
Pre Amp Type	JC-120, CLEAN TWIN, MATCH DRIVE, BG LEAD, MS1959I, MS1959II, MS1959I+II, SLDN LEAD, METAL5150, METAL LEAD, OD-1, OD-2 TURBO, DISTORTION, FUZZ	Type of guitar amp
Pre Amp Volume #	0-127	Volume and amount of distortion of the amp
Pre Amp Master #	0-127	Volume of the entire pre-amp
Pre Amp Gain	LOW, MIDDLE, HIGH	Amount of pre-amp distortion
Pre Amp Bass	0-127	Tone of the bass/mid/treble frequency range * Middle cannot be set if "Match Drive" is selected as the Pre Amp Type.
Pre Amp Middle		
Pre Amp Treble		
Pre Amp Presence	0-127 (MATCH DRIVE: -127 - 0)	Tone for the ultra-high frequency range
Pre Amp Bright	OFF, ON	Turning this "On" produces a sharper and brighter sound. * This parameter applies to the "JC-120," "Clean Twin," and "BG Lead" Pre Amp Types.
Speaker Sw	OFF, ON	Determines whether the signal passes through the speaker (ON), or not (OFF).
Speaker Type	(See the table below.)	Type of speaker
Mic Setting	1, 2, 3	Adjusts the location of the mic that's capturing the sound of the speaker. This can be adjusted in three steps, from 1 to 3, with the mic becoming more distant as the value increases.
Mic Level	0-127	Volume of the microphone
Direct Level	0-127	Volume of the direct sound
Pan #	L64-63R	Stereo location of the output
Level #	0-127	Output level

Specifications for each Speaker Type

The speaker column indicates the diameter of each speaker unit (in inches) and the number of units.

Type	Cabinet	Speaker	Microphone
SMALL 1	small open-back enclosure	10	dynamic
SMALL 2	small open-back enclosure	10	dynamic
MIDDLE	open back enclosure	12 x 1	dynamic
JC-120	open back enclosure	12 x 2	dynamic
BUILT-IN 1	open back enclosure	12 x 2	dynamic
BUILT-IN 2	open back enclosure	12 x 2	condenser
BUILT-IN 3	open back enclosure	12 x 2	condenser
BUILT-IN 4	open back enclosure	12 x 2	condenser
BUILT-IN 5	open back enclosure	12 x 2	condenser
BG STACK 1	sealed enclosure	12 x 2	condenser
BG STACK 2	large sealed enclosure	12 x 2	condenser
MS STACK 1	large sealed enclosure	12 x 4	condenser
MS STACK 2	large sealed enclosure	12 x 4	condenser
METAL STACK	large double stack	12 x 4	condenser
2-STACK	large double stack	12 x 4	condenser
3-STACK	large triple stack	12 x 4	condenser

Effects List

40: COMPRESSOR

Flattens out high levels and boosts low levels, smoothing out fluctuations in volume.



Parameter	Value	Description
Attack #	0-127	Sets the speed at which compression starts
Threshold #	0-127	Adjusts the volume at which compression begins
Post Gain	0- +18 dB	Adjusts the output gain.
Low Gain	-15- +15 dB	Gain of the low frequency range
High Gain	-15- +15 dB	Gain of the high frequency range
Level #	0-127	Output level

41: LIMITER

Compresses signals that exceed a specified volume level, preventing distortion from occurring.



Parameter	Value	Description
Release #	0-127	Adjusts the time after the signal volume falls below the Threshold Level until compression is no longer applied.
Threshold #	0-127	Adjusts the volume at which compression begins
Ratio	1.5:1, 2:1, 4:1, 100:1	Compression ratio
Post Gain	0- +18 dB	Adjusts the output gain.
Low Gain	-15- +15 dB	Gain of the low frequency range
High Gain	-15- +15 dB	Gain of the high frequency range
Level #	0-127	Output level

42: GATE

Cuts the reverb's delay according to the volume of the sound sent into the effect. Use this when you want to create an artificial-sounding decrease in the reverb's decay.

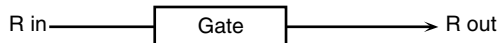
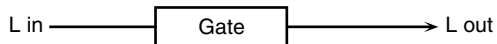

Parameter	Value	Description
Threshold #	0-127	Volume level at which the gate begins to close
Mode	GATE, DUCK	Type of gate GATE: The gate will close when the volume of the original sound decreases, cutting the original sound. DUCK (Ducking): The gate will close when the volume of the original sound increases, cutting the original sound.
Attack	0-127	Adjusts the time it takes for the gate to fully open after being triggered.

Parameter	Value	Description
Hold	0-127	Adjusts the time it takes for the gate to start closing after the source sound falls beneath the Threshold.
Release	0-127	Adjusts the time it takes the gate to fully close after the hold time.
Balance #	D100:0W- D0:100W	Volume balance between the direct sound (D) and the effect sound (W)
Level	0-127	Output level

43: DELAY

This is a stereo delay.

When Feedback Mode is NORMAL:

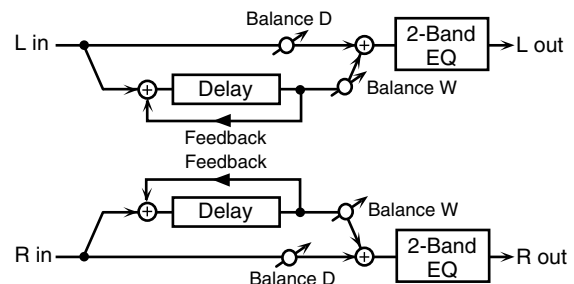

When Feedback Mode is CROSS:

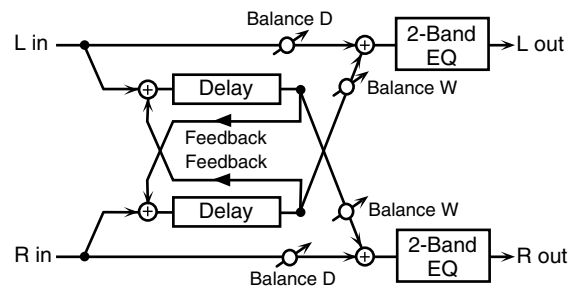

Parameter	Value	Description
Delay Left	0-1300 ms, note	Adjusts the time until the delay sound is heard.
Delay Right		
Phase Left	NORMAL, INVERSE	Phase of the delay sound
Phase Right		
Feedback Mode	NORMAL, CROSS	Selects the way in which delay sound is fed back into the effect. (See the figures above.)
Feedback #	-98- +98 %	Adjusts the amount of the delay sound that's fed back into the effect. Negative (-) settings invert the phase.
HF Damp	200-8000 Hz, BYPASS	Adjusts the frequency above which sound fed back to the effect is filtered out. If you don't want to filter out any high frequencies, set this parameter to BYPASS.
Low Gain	-15- +15 dB	Gain of the low frequency range
High Gain	-15- +15 dB	Gain of the high frequency range
Balance #	D100:0W- D0:100W	Volume balance between the direct sound (D) and the delay sound (W)
Level	0-127	Output level

44: LONG DELAY

A delay that provides a long delay time.

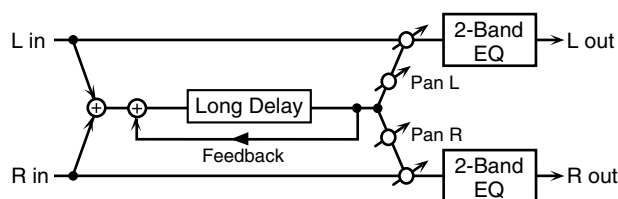

Parameter	Range	Explanation
Delay Time	0–2600 ms, note	Delay time from when the original sound is heard to when the delay sound is heard
Phase	NORMAL, INVERSE	Phase of the delay (NORMAL: non-inverted, INVERT: inverted)
Feedback #	-98– +98%	Proportion of the delay sound that is to be returned to the input (negative values invert the phase)
HF Damp	200–8000 Hz, BYPASS	Frequency at which the high-frequency content of the delayed sound will be cut (BYPASS: no cut)
Pan #	L64–63R	Panning of the delay sound
Low Gain	-15– +15 dB	Amount of boost/cut for the low-frequency range
High Gain	-15– +15 dB	Amount of boost/cut for the high-frequency range
Balance #	D100:0W–D0:100W	Volume balance of the original sound (D) and delay sound (W)
Level	0–127	Output volume

45: SERIAL DELAY

This delay connects two delay units in series. Feedback can be applied independently to each delay unit, allowing you to produce complex delay sounds.

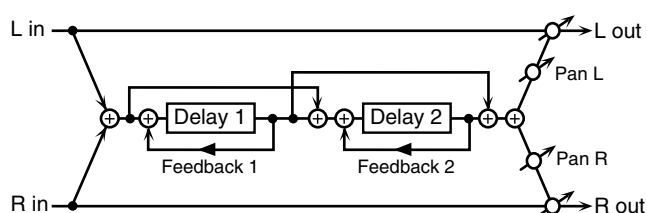

Parameter	Range	Explanation
Delay1 Time	0–1300 ms, note	Delay time from when sound is input to delay 1 until the delay sound is heard
Delay1 Feedback #	-98– +98%	Proportion of the delay sound that is to be returned to the input of delay 1 (negative values invert the phase)
Delay1 HF Damp	200–8000 Hz, BYPASS	Frequency at which the high-frequency content of the delayed sound of delay 1 will be cut (BYPASS: no cut)
Delay2 Time	0–1300 ms, note	Delay time from when sound is input to delay 2 until the delay sound is heard
Delay2 Feedback #	-98– +98%	Proportion of the delay sound that is to be returned to the input of delay 2 (negative values invert the phase)

Parameter	Range	Explanation
Delay2 HF Damp	200–8000 Hz, BYPASS	Frequency at which the high-frequency content of the delayed sound of delay 2 will be cut (BYPASS: no cut)
Pan #	L64–63R	Panning of the delay sound
Low Gain	-15– +15 dB	Amount of boost/cut for the low-frequency range
High Gain	-15– +15 dB	Amount of boost/cut for the high-frequency range
Balance #	D100:0W–D0:100W	Volume balance of the original sound (D) and delay sound (W)
Level	0–127	Output volume

46: MODULATION DELAY

Adds modulation to the delayed sound.

When Feedback Mode is NORMAL:

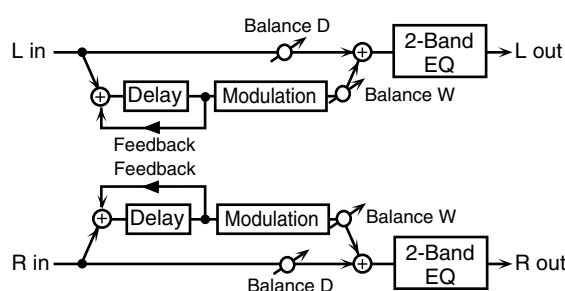

When Feedback Mode is CROSS:

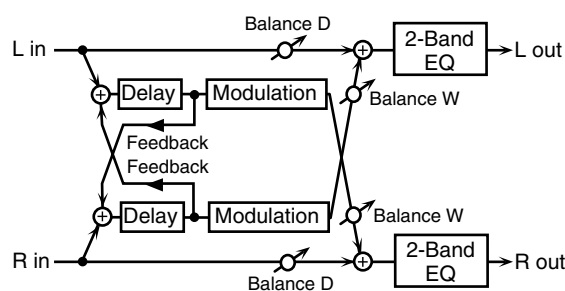

Parameter	Value	Description
Delay Left	0–1300 ms, note	Adjusts the time until the delay sound is heard.
Delay Right	0–1300 ms, note	Adjusts the time until the delay sound is heard.
Feedback Mode	NORMAL, CROSS	Selects the way in which delay sound is fed back into the effect (See the figures above.)
Feedback #	-98– +98 %	Adjusts the amount of the delay sound that's fed back into the effect. Negative (-) settings invert the phase.
HF Damp	200–8000 Hz, BYPASS	Adjusts the frequency above which sound fed back to the effect is filtered out. If you don't want to filter out any high frequencies, set this parameter to BYPASS.
Rate #	0.05–10.00 Hz, note	Frequency of modulation
Depth	0–127	Depth of modulation
Phase	0–180 deg	Spatial spread of the sound
Low Gain	-15– +15 dB	Gain of the low frequency range
High Gain	-15– +15 dB	Gain of the high frequency range
Balance #	D100:0W–D0:100W	Volume balance between the direct sound (D) and the delay sound (W)
Level	0–127	Output level

Effects List

47: 3TAP PAN DELAY

Produces three delay sounds; center, left and right.

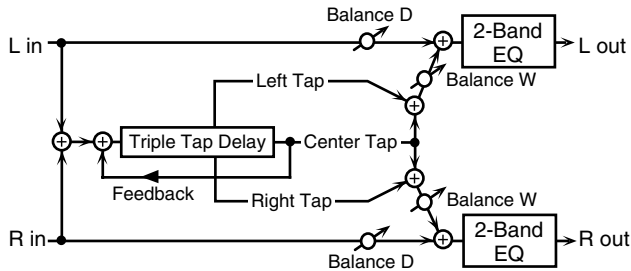

Parameter	Value	Description
Delay Left/Right/Center	0–2600 ms, note	Adjusts the time until the delay sound is heard.
Center Feedback #	-98– +98 %	Adjusts the amount of the delay sound that's fed back into the effect. Negative (-) settings invert the phase.
HF Damp	200–8000 Hz, BYPASS	Adjusts the frequency above which sound fed back to the effect is filtered out. If you do not want to filter out any high frequencies, set this parameter to BYPASS.
Left/Right/Center Level	0–127	Volume of each delay
Low Gain	-15– +15 dB	Gain of the low frequency range
High Gain	-15– +15 dB	Gain of the high frequency range
Balance #	D100:0W– D0:100W	Volume balance between the direct sound (D) and the delay sound (W)
Level	0–127	Output level

48: 4TAP PAN DELAY

This effect has four delays.

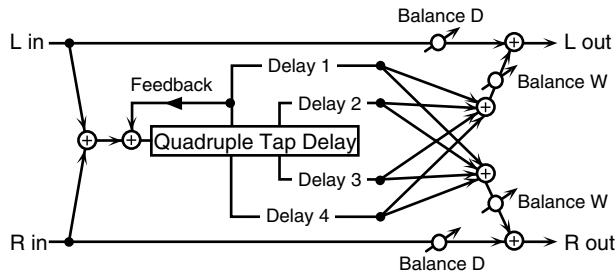

Stereo location of each delay

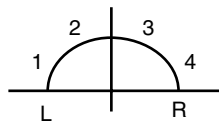

Parameter	Value	Description
Delay 1–4 Time	0–2600 ms, note	Adjusts the time until the delay sound is heard.
Delay 1 Feedback #	-98– +98 %	Adjusts the amount of the delay sound that's fed back into the effect. Negative (-) settings invert the phase.
HF Damp	200–8000 Hz, BYPASS	Adjusts the frequency above which sound fed back to the effect is filtered out. If you do not want to filter out any high frequencies, set this parameter to BYPASS.
Delay 1–4 Level	0–127	Volume of each delay
Low Gain	-15– +15 dB	Gain of the low frequency range
High Gain	-15– +15 dB	Gain of the high frequency range
Balance #	D100:0W– D0:100W	Volume balance between the direct sound (D) and the delay sound (W)
Level	0–127	Output level

49: MULTI TAP DELAY

This effect provides four delays. Each of the Delay Time parameters can be set to a note length based on the selected tempo. You can also set the panning and level of each delay sound.

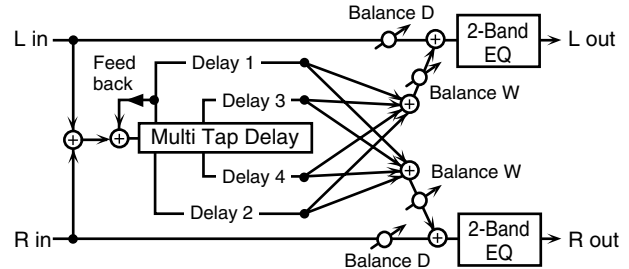

Parameter	Value	Description
Delay 1–4 Time	0–2600 ms, note	Adjusts the time until Delays 1–4 are heard.
Delay 1 Feedback #	-98– +98 %	Adjusts the amount of the delay sound that's fed back into the effect. Negative (-) settings invert the phase.
HF Damp	200–8000 Hz, BYPASS	Adjusts the frequency above which sound fed back to the effect is filtered out. If you don't want to filter out any the high frequencies, set this parameter to BYPASS.
Delay 1–4 Pan	L64–63R	Stereo location of Delays 1–4
Delay 1–4 Level	0–127	Output level of Delays 1–4
Low Gain	-15– +15 dB	Gain of the low frequency range
High Gain	-15– +15 dB	Gain of the high frequency range
Balance #	D100:0W– D0:100W	Volume balance between the direct sound (D) and the effect sound (W)
Level	0–127	Output level

50: REVERSE DELAY

This is a reverse delay that adds a reversed and delayed sound to the input sound. A tap delay is connected immediately after the reverse delay.

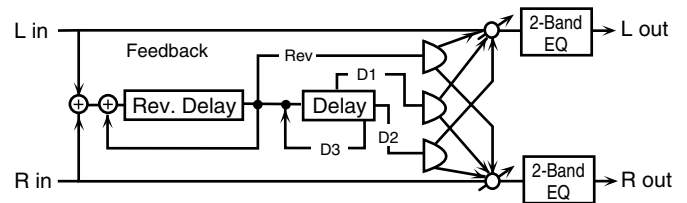

Parameter	Range	Explanation
Threshold	0–127	Volume at which the reverse delay will begin to be applied
Rev Delay Time	0–1300 ms, note	Delay time from when sound is input into the reverse delay until the delay sound is heard
Rev Delay Feedback #	-98– +98%	Proportion of the delay sound that is to be returned to the input of the reverse delay (negative values invert the phase)
Rev Delay HF Damp	200–8000 Hz, BYPASS	Frequency at which the high-frequency content of the reverse-delayed sound will be cut (BYPASS: no cut)
Rev Delay Pan	L64–63R	Panning of the reverse delay sound
Rev Delay Level	0–127	Volume of the reverse delay sound
Delay 1 – 3 Time	0–1300 ms, note	Delay time from when sound is input into the tap delay until the delay sound is heard

Parameter	Range	Explanation
Delay 3 Feedback #	-98– +98%	Proportion of the delay sound that is to be returned to the input of the tap delay (negative values invert the phase)
Delay HF Damp	200–8000 Hz, BY-PASS	Frequency at which the low-frequency content of the tap delay sound will be cut (BY-PASS: no cut)
Delay 1 Pan', 'Delay 2 Pan	L64–63R	Panning of the tap delay sounds
Delay 1 Level', 'Delay 2 Level	0–127	Volume of the tap delay sounds
Low Gain	-15– +15 dB	Amount of boost/cut for the low-frequency range
High Gain	-15– +15 dB	Amount of boost/cut for the high-frequency range
Balance #	D100:0W–D0:100W	Volume balance of the original sound (D) and delay sound (W)
Level	0–127	Output volume

51: SHUFFLE DELAY

Adds a shuffle to the delay sound, giving the sound a bouncy delay effect with a swing feel.

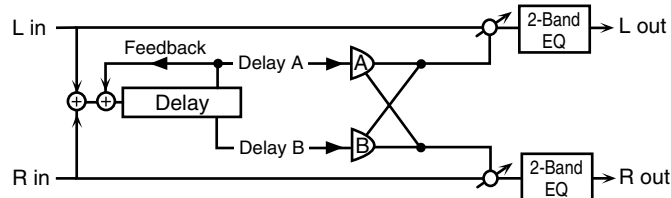

Parameter	Value	Description
Delay Time #	0–2600 ms, note	Adjusts the time until the delay sound is heard.
Shuffle Rate #	0–100 %	Adjusts the ratio (as a percentage) of the time that elapses before Delay B sounds relative to the time that elapses before the Delay A sounds. When set to 100%, the delay times are the same.
Acceleration	0–15	Adjusts the time over which the Delay Time changes from the current setting to its specified new setting.
Feedback #	-98– +98 %	Adjusts the amount of the delay that's fed back into the effect. Negative (-) settings invert the phase.
HF Damp	200–8000Hz, BYPASS	Adjusts the frequency above which sound fed back to the effect is filtered out. If you don't want to filter out any high frequencies, set this parameter to BYPASS.
Pan A/B	0–127	Stereo location of Delay A/B
Level A/B	0–127	Volume of delay A/B
Low Gain	-15– +15 dB	Gain of the low frequency range
High Gain	-15– +15 dB	Gain of the high frequency range
Balance #	D100:0W–D0:100W	Volume balance between the direct sound (D) and the effect sound (W)
Level	0–127	Output level

52: 3D DELAY

This applies a 3D effect to the delay sound. The delay sound will be positioned 90 degrees left and 90 degrees right.

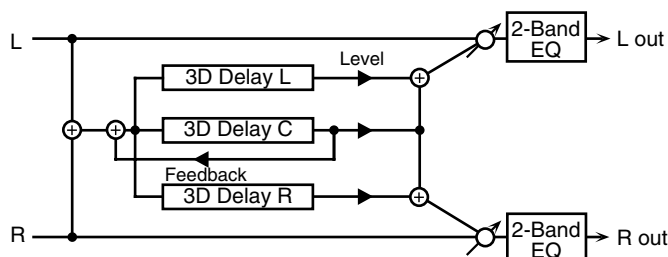

Parameter	Value	Description
Delay Left	0–2600 ms, note	Adjusts the delay time from the direct sound until the delay sound is heard.
Delay Right		
Delay Center		
Center Feedback #	-98– +98 %	Adjusts the proportion of the delay sound that is fed back into the effect. Negative (-) settings will invert the phase.
HF Damp	200–8000 Hz, BYPASS	Adjusts the frequency above which sound fed back to the effect will be cut. If you do not want to cut the high frequencies, set this parameter to BY-PASS.
Left Level	0–127	Output level of the delay sound
Right Level		
Center Level		
Output Mode	SPEAKER, PHONES	Adjusts the method that will be used to hear the sound that is output to the OUTPUT jacks. The optimal 3D effect will be achieved if you select SPEAKER when using speakers, or PHONES when using headphones.
Low Gain	-15– +15 dB	Gain of the low range
High Gain	-15– +15 dB	Gain of the high range
Balance #	D100:0W–D0:100W	Volume balance between the direct sound (D) and the effect sound (W)
Level	0–127	Output Level

53: TIME CTRL DELAY

A stereo delay in which the delay time can be varied smoothly.

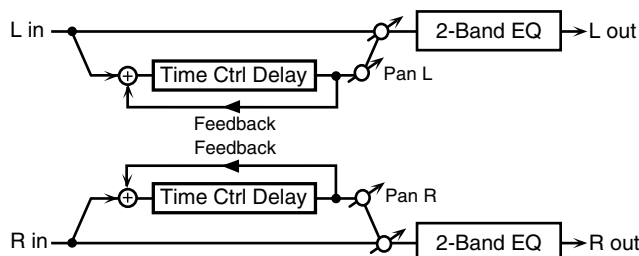

Parameter	Value	Description
Delay Time #	0–1300 ms, note	Adjusts the time until the delay is heard.
Acceleration	0–15	Adjusts the time over which the Delay Time changes from the current setting to a specified new setting. The rate of change for the Delay Time directly affects the rate of pitch change.
Feedback #	-98– +98 %	Adjusts the amount of the delay that's fed back into the effect. Negative (-) settings invert the phase.
HF Damp	200–8000 Hz, BYPASS	Adjusts the frequency above which sound fed back to the effect is filtered out. If you do not want to filter out any high frequencies, set this parameter to BYPASS.
Low Gain	-15– +15 dB	Gain of the low frequency range
High Gain	-15– +15 dB	Gain of the high frequency range
Balance #	D100:0W–D0:100W	Volume balance between the direct sound (D) and the delay sound (W)
Level	0–127	Output level

Effects List

54: LONG TIME CTRL DELAY

A delay in which the delay time can be varied smoothly, and allowing an extended delay to be produced.

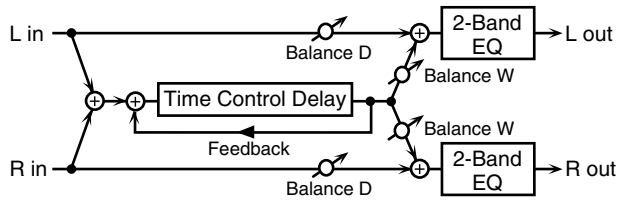

Parameter	Value	Description
Delay Time #	0–2600 ms, note	Adjusts the time until the delay is heard.
Acceleration	0–15	Adjusts the time over which the Delay Time changes from the current setting to a specified new setting. The rate of change for the Delay Time directly affects the rate of pitch change.
Feedback #	-98– +98 %	Adjusts the amount of the delay that's fed back into the effect. Negative (-) settings invert the phase.
HF Damp	200–8000 Hz, BYPASS	Adjusts the frequency above which sound fed back to the effect is filtered out. If you do not want to filter out any high frequencies, set this parameter to BYPASS.
Pan #	L64–63R	Stereo location of the delay
Low Gain	-15– +15 dB	Gain of the low frequency range
High Gain	-15– +15 dB	Gain of the high frequency range
Balance #	D100:0W– D0:100W	Volume balance between the direct sound (D) and the delay sound (W)
Level	0–127	Output level

55: TAPE ECHO

A virtual tape echo that produces a realistic tape delay sound. This simulates the tape echo section of a Roland RE-201 Space Echo.

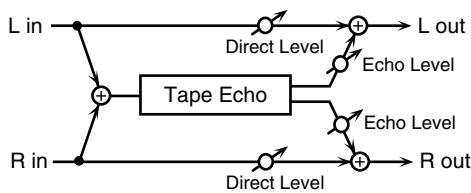

Parameter	Value	Description
Mode	S, M, L, S+M, S+L, M+L, S+M+L	Combination of playback heads to use Select from three different heads with different delay times. S: short M: middle L: long
Repeat Rate #	0–127	Tape speed Increasing this value will shorten the spacing of the delayed sounds.
Intensity #	0–127	Amount of delay repeats
Bass	-15– +15 dB	Boost/cut for the lower range of the echo sound
Treble	-15– +15 dB	Boost/cut for the upper range of the echo sound
Head S Pan	L64–63R	Independent panning for the short, middle, and long playback heads
Head M Pan		
Head L Pan		
Tape Distortion	0–5	Amount of tape-dependent distortion to be added This simulates the slight tonal changes that can be detected by signal-analysis equipment. Increasing this value will increase the distortion.

Parameter	Value	Description
Wow/Flutter Rate	0–127	Speed of wow/flutter (complex variation in pitch caused by tape wear and rotational irregularity)
Wow/Flutter Depth	0–127	Depth of wow/flutter
Echo Level #	0–127	Volume of the echo sound
Direct Level #	0–127	Volume of the original sound
Level	0–127	Output level

56: LOFI NOISE

In addition to a lo-fi effect, this adds various types of noise such as white noise and disc noise.

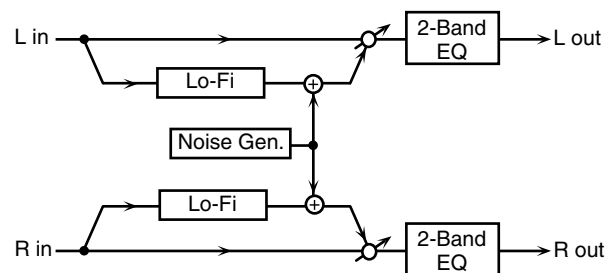

Parameter	Value	Description
LoFi Type	1–9	Degrades the sound quality. The sound quality grows poorer as this value is increased.
Post Filter Type	OFF, LPF, HPF	Type of filter OFF: no filter is used LPF: cuts the frequency range above the Cutoff HPF: cuts the frequency range below the Cutoff
Post Filter Cutoff	200–8000 Hz	Center frequency of the filter
W/P Noise Type	WHITE, PINK	Switch between white noise and pink noise.
W/P Noise LPF	200–8000 Hz, BYPASS	Center frequency of the low pass filter applied to the white/pink noise (BYPASS: no cut)
W/P Noise Level #	0–127	Volume of the white/pink noise
Disc Noise Type	LP, EP, SP, RND	Type of record noise The frequency at which the noise is heard depends on the selected type.
Disc Noise LPF	200–8000 Hz, BYPASS	Adjusts the cutoff frequency of the low pass filter applied to the record noise. If you don't want to filter out any high frequencies, set this parameter to BYPASS.
Disc Noise Level #	0–127	Volume of the record noise
Hum Noise Type	50 Hz, 60 Hz	Frequency of the hum noise
Hum Noise LPF	200–8000 Hz, BYPASS	Center frequency of the low pass filter applied to the hum noise (BYPASS: no cut)
Hum Noise Level #	0–127	Volume of the hum noise
Low Gain	-15– +15 dB	Gain of the low range
High Gain	-15– +15 dB	Gain of the high range
Balance #	D100:0W– D0:100W	Volume balance between the direct sound (D) and the effect sound (W)
Level	0–127	Output level

57: LOFI COMPRESS

This is an effect that intentionally degrades the sound quality for creative purposes.

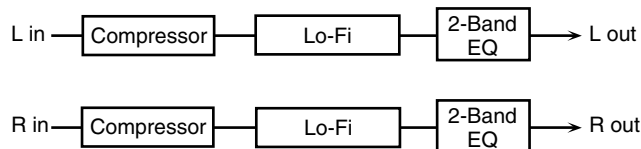

Parameter	Value	Description
Pre Filter Type	1-6	Selects the type of filter applied to the sound before it passes through the Lo-Fi effect.
LoFi Type	1-9	Degrades the sound quality. The sound quality grows poorer as this value is increased.
Post Filter Type	OFF, LPF, HPF	Type of filter OFF: no filter is used LPF: cuts the frequency range above the Cutoff HPF: cuts the frequency range below the Cutoff
Post Filter Cutoff	200-8000 Hz	Basic frequency of the Post Filter
Low Gain	-15- +15 dB	Gain of the low range
High Gain	-15- +15 dB	Gain of the high range
Balance #	D100:0W- D0:100W	Volume balance between the direct sound (D) and the effect sound (W)
Level #	0-127	Output level

58: LOFI RADIO

In addition to a Lo-Fi effect, this effect also generates radio noise.

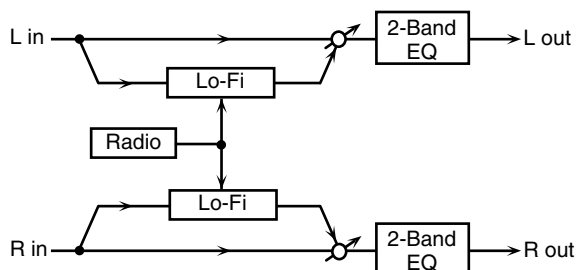

Parameter	Value	Description
LoFi Type	1-9	Degrades the sound quality. The sound quality grows poorer as this value is increased.
Post Filter Type	OFF, LPF, HPF	Type of filter OFF: no filter is used LPF: cuts the frequency range above the Cutoff HPF: cuts the frequency range below the Cutoff
Post Filter Cutoff	200-8000 Hz	Basic frequency of the Post Filter
Radio Detune #	0-127	Simulates the tuning noise of a radio. As this value is raised, the tuning drifts further.
Radio Noise Level #	0-127	Volume of the radio noise
Balance #	D100:0W- D0:100W	Volume balance between the direct sound (D) and the effect sound (W)
Level	0-127	Output level

59: TELEPHONE

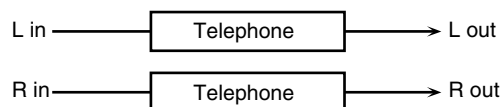

Parameter	Value	Description
Voice Quality #	0-15	Audio quality of the telephone voice
Treble	-15- +15 dB	Bandwidth of the telephone voice
Balance #	D100:0- D0:100W	Volume balance between the direct sound (D) and the effect sound (W)
Level	0-127	Output level

60: PHONOGRAPH

Simulates a sound recorded on an analog record and played back on a record player. This effect also simulates the various types of noise that are typical of a record, and even the rotational irregularities of an old turntable.

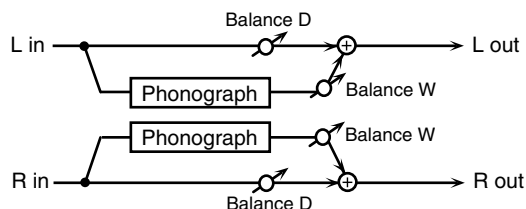

Parameter	Value	Description
Signal Distortion	0-127	Depth of distortion
Frequency Range	0-127	Frequency response of the playback system Decreasing this value will produce the impression of an old system with a poor frequency response.
Disc Type	LP, EP, SP	Rotational speed of the turntable This will affect the frequency of the scratch noise.
Scratch Noise Level	0-127	Amount of noise due to scratches on the record
Dust Noise Level	0-127	Volume of noise due to dust on the record
Hiss Noise Level	0-127	Volume of continuous "hiss"
Total Noise Level #	0-127	Volume of overall noise
Wow	0-127	Depth of long-cycle rotational irregularity
Flutter	0-127	Depth of short-cycle rotational irregularity
Random	0-127	Depth of indefinite-cycle rotational irregularity
Total Wow/Flutter #	0-127	Depth of overall rotational irregularity
Balance #	D100:0W- D0:100W	Volume balance between the direct sound (D) and the effect sound (W)
Level	0-127	Output level

Effects List

61: PITCH SHIFTER (Feedback Pitch Shifter)

A stereo pitch shifter.

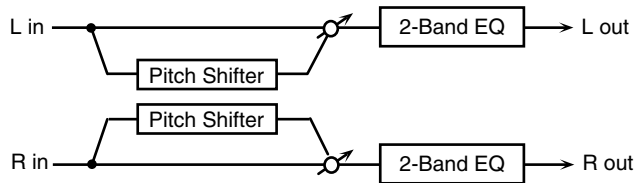

Parameter	Value	Description
Coarse #1	-24– +12 semi	Adjusts the pitch of the pitch shifted sound in semitone steps.
Fine #1	-100– +100 cent	Adjusts the pitch of the pitch shifted sound in 2-cent steps.
Delay Time	0–1300 ms, note	Adjusts the delay time from the direct sound until the pitch shifted sound is heard.
Feedback #	-98– +98 %	Adjusts the proportion of the pitch shifted sound that is fed back into the effect. Negative (-) settings will invert the phase.
Low Gain	-15– +15 dB	Gain of the low range
High Gain	-15– +15 dB	Gain of the high range
Balance #	D100:0W–D0:100W	Volume balance between the direct sound (D) and the pitch shifted sound (W)
Level	0–127	Output Level

62: 2VOICE PITCH SHIFTER

Shifts the pitch of the original sound. This 2-voice pitch shifter has two pitch shifters, and can add two pitch shifted sounds to the original sound.

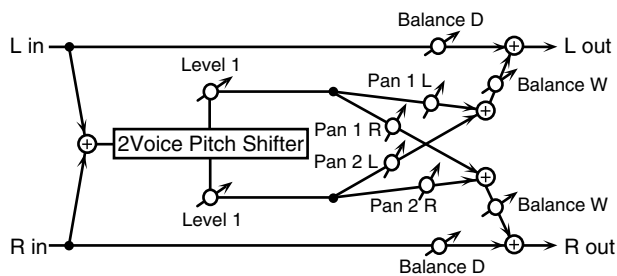

Parameter	Value	Description
Pitch 1: Coarse #1	-24+12 semi	Adjusts the pitch of Pitch Shift 1 in semitone steps.
Pitch 1:Fine #1	-100+100 cent	Adjusts the pitch of Pitch Shift 1 in 2-cent steps.
Pitch 1:Delay	0–1300 ms, note	Adjusts the delay time from the direct sound until the Pitch Shift 1 sound is heard.
Pitch 1:Feed-back #	-98– +98 %	Adjusts the proportion of the pitch shifted sound that is fed back into the effect. Negative (-) settings will invert the phase.
Pitch 1:Pan #	L64-63R	Stereo location of the Pitch Shift 1 sound
Pitch 1:Level	0–127	Volume of the Pitch Shift1 sound
Pitch 2: Coarse #2	-24+12 semi	Settings of the Pitch Shift 2 sound.
Pitch 2:Fine #2	-100+100 cent	The parameters are the same as for the Pitch Shift 1 sound.
Pitch 2:Delay	0–1300 ms, note	
Pitch 2:Feed-back #	-98– +98 %	
Pitch 2:Pan #	L64-63R	
Pitch 2:Level	0–127	
Low Gain	-15– +15 dB	Gain of the low range

Parameter	Value	Description
High Gain	-15– +15 dB	Gain of the high range
Level Balance	A100:0B-A0:100B	Volume balance between the Pitch Shift 1 and Pitch Shift 2 sounds
Balance	D100:0W-D0:100W	Volume balance between the direct sound (D) and the pitch shifted sound (W)
Level	0-127	Output Level

63: STEP PITCH SHIFTER

A pitch shifter in which the amount of pitch shift is varied by a 16-step sequence.

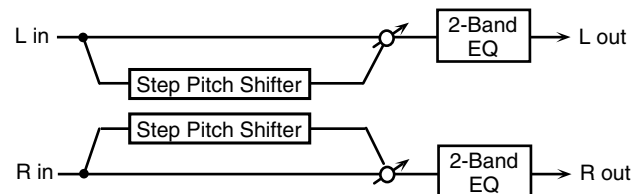

Parameter	Range	Explanation
Step 01–16	-24+12 semi	Amount of pitch shift at each step (semitone units)
Rate #	0.05–10.00 Hz, note	Rate at which the 16-step sequence will cycle
Attack #	0–127	Speed at which the amount of pitch shift changes between steps
Gate Time #	0–127	Duration of the pitch shifted sound at each step
Fine	-100– +100 cent	Pitch shift adjustment for all steps (2-cent units)
Delay Time	0–1300 ms, note	Delay time from the original sound until the pitch-shifted sound is heard
Feedback #	-98– +98%	Proportion of the pitch-shifted sound that is to be returned to the input (negative values invert the phase)
Low Gain	-15– +15 dB	Amount of boost/cut for the low-frequency range
High Gain	-15– +15 dB	Amount of boost/cut for the high-frequency range
Balance #	D100:0W–D0:100W	Volume balance of the original sound (D) and pitch-shifted sound (W)
Level	0–127	Output volume

64: REVERB

Adds reverberation to the sound, simulating an acoustic space.

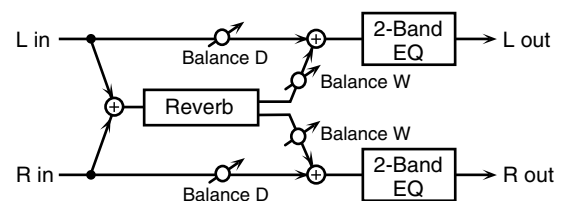

Parameter	Value	Description
Type	ROOM1, ROOM2, STAGE1, STAGE2, HALL1, HALL2	Type of reverb ROOM1: dense reverb with short decay ROOM2: sparse reverb with short decay STAGE1: reverb with greater late reverberation STAGE2: reverb with strong early reflections HALL1: reverb with clear reverberance HALL2: reverb with rich reverberance
Pre Delay	0.0–100.0 ms	Adjusts the delay time from the direct sound until the reverb sound is heard.
Time #	0–127	Time length of reverberation
HF Damp	200–8000 Hz, BYPASS	Adjusts the frequency above which the reverberant sound will be cut. As the frequency is set lower, more of the high frequencies will be cut, resulting in a softer and more muted reverberance. If you do not want to cut the high frequencies, set this parameter to BYPASS.
Low Gain	-15– +15 dB	Gain of the low range
High Gain	-15– +15 dB	Gain of the high range
Balance #	D100:0W–D0:100W	Volume balance between the direct sound (D) and the reverb sound (W)
Level	0–127	Output Level

65: GATED REVERB

This is a special type of reverb in which the reverberant sound is cut off before its natural length.

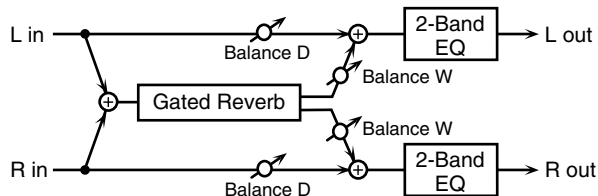

Parameter	Value	Description
Type	NORMAL, REVERSE, SWEEP1, SWEEP2	Type of reverb NORMAL: conventional gated reverb REVERSE: backwards reverb SWEEP1: the reverberant sound moves from right to left SWEEP2: the reverberant sound moves from left to right
Pre Delay	0.0–100.0 ms	Adjusts the delay time from the direct sound until the reverb sound is heard.
Gate Time	5–500 ms	Adjusts the time from when the reverb is heard until it disappears.
Low Gain	-15– +15 dB	Gain of the low range
High Gain	-15– +15 dB	Gain of the high range
Balance #	D100:0W–D0:100W	Volume balance between the direct sound (D) and the reverb sound (W)
Level #	0–127	Output Level

66: OVERDRIVE → CHORUS

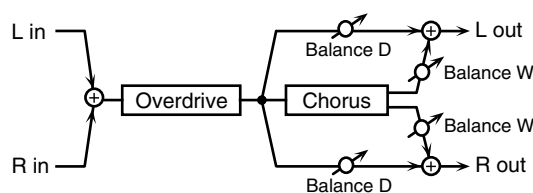

Parameter	Value	Description
Overdrive Drive #	0–127	Degree of distortion Also changes the volume.
Overdrive Pan #	L64–63R	Stereo location of the overdrive sound
Chorus Pre Delay	0.0–100.0 ms	Adjusts the delay time from the direct sound until the chorus sound is heard.
Chorus Rate #	0.05–10.00 Hz, note	Frequency of modulation
Chorus Depth	0–127	Depth of modulation
Chorus Balance #	D100:0W–D0:100W	Adjusts the volume balance between the sound that is sent through the chorus (W) and the sound that is not sent through the chorus (D).
Level	0–127	Output Level

67: OVERDRIVE → FLANGER

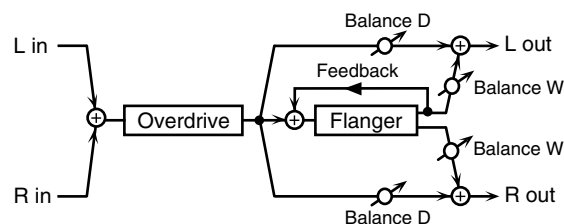

Parameter	Value	Description
Overdrive Drive #	0–127	Degree of distortion Also changes the volume.
Overdrive Pan #	L64–63R	Stereo location of the overdrive sound
Flanger Pre Delay	0.0–100.0 ms	Adjusts the delay time from when the direct sound begins until the flanger sound is heard.
Flanger Rate #	0.05–10.00 Hz, note	Frequency of modulation
Flanger Depth	0–127	Depth of modulation
Flanger Feedback #	-98– +98 %	Adjusts the proportion of the flanger sound that is fed back into the effect. Negative (-) settings will invert the phase.
Flanger Balance #	D100:0W–D0:100W	Adjusts the volume balance between the sound that is sent through the flanger (W) and the sound that is not sent through the flanger (D).
Level	0–127	Output Level

Effects List

68: OVERDRIVE → DELAY

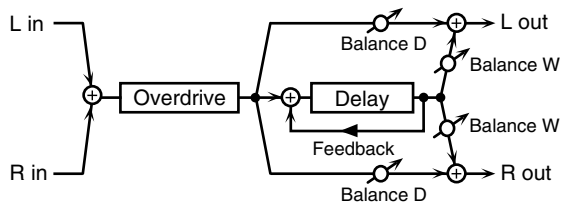

Parameter	Value	Description
Overdrive Drive #	0–127	Degree of distortion Also changes the volume.
Overdrive Pan #	L64–63R	Stereo location of the overdrive sound
Delay Time	0–2600 ms, note	Adjusts the delay time from the direct sound until the delay sound is heard.
Delay Feedback #	-98– +98 %	Adjusts the proportion of the delay sound that is fed back into the effect. Negative (-) settings will invert the phase.
Delay HF Damp	200–8000 Hz, BYPASS	Adjusts the frequency above which sound fed back to the effect will be cut. If you do not want to cut the high frequencies, set this parameter to BY-PASS.
Delay Balance #	D100:0W–D0:100W	Adjusts the volume balance between the sound that is sent through the delay (W) and the sound that is not sent through the delay (D).
Level	0–127	Output Level

69: DISTORTION → CHORUS

The parameters are essentially the same as in “66: OVERDRIVE → CHORUS,” with the exception of the following two.
Overdrive Drive → Distortion Drive, Overdrive Pan → Distortion Pan

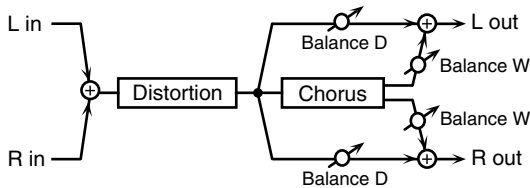

70: DISTORTION → FLANGER

The parameters are essentially the same as in “67: OVERDRIVE → FLANGER,” with the exception of the following two.
Overdrive Drive → Distortion Drive, Overdrive Pan → Distortion Pan

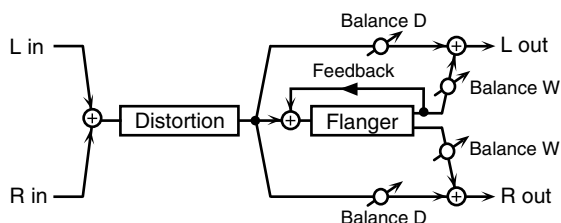

71: DISTORTION → DELAY

The parameters are essentially the same as in “68: OVERDRIVE →

DELAY,” with the exception of the following two.

Overdrive Drive → Distortion Drive, Overdrive Pan → Distortion Pan

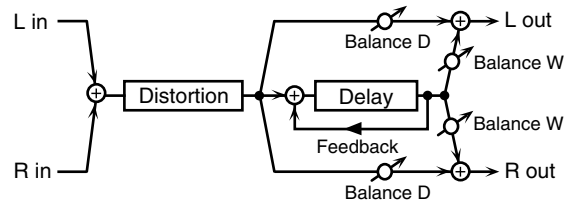

72: ENHANCER → CHORUS

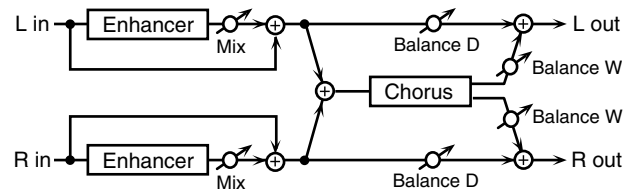

Parameter	Value	Description
Enhancer Sens #	0–127	Sensitivity of the enhancer
Enhancer Mix #	0–127	Level of the overtones generated by the enhancer
Chorus Pre Delay	0.0–100.0 ms	Adjusts the delay time from the direct sound until the chorus sound is heard.
Chorus Rate #	0.05–10.00 Hz, note	Frequency of modulation
Chorus Depth	0–127	Depth of modulation
Chorus Balance #	D100:0W– D0:100W	Adjusts the volume balance between the sound that is sent through the chorus (W) and the sound that is not sent through the chorus (D).
Level	0–127	Output Level

73: ENHANCER → FLANGER

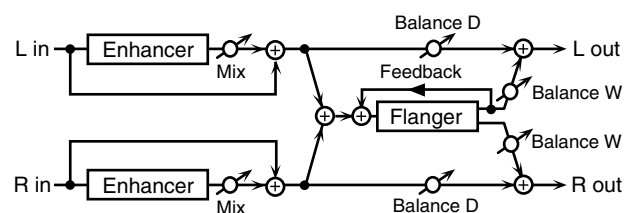

Parameter	Value	Description
Enhancer Sens #	0–127	Sensitivity of the enhancer
Enhancer Mix #	0–127	Level of the overtones generated by the enhancer
Flanger Pre Delay	0.0–100.0 ms	Adjusts the delay time from when the direct sound begins until the flanger sound is heard.
Flanger Rate #	0.05–10.00 Hz, note	Frequency of modulation
Flanger Depth	0–127	Depth of modulation
Flanger Feedback #	-98– +98 %	Adjusts the proportion of the flanger sound that is fed back into the effect. Negative (-) settings will invert the phase.
Flanger Balance #	D100:0W– D0:100W	Adjusts the volume balance between the sound that is sent through the flanger (W) and the sound that is not sent through the flanger (D).
Level	0–127	Output Level

74: ENHANCER → DELAY

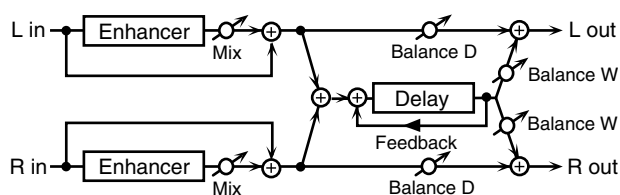

Parameter	Value	Description
Enhancer Sens #	0-127	Sensitivity of the enhancer
Enhancer Mix #	0-127	Level of the overtones generated by the enhancer
Delay Time	0-2600 ms, note	Adjusts the delay time from the direct sound until the delay sound is heard.
Delay Feedback #	-98- +98 %	Adjusts the proportion of the delay sound that is fed back into the effect. Negative (-) settings will invert the phase.
Delay HF Damp	200-8000 Hz, BYPASS	Adjusts the frequency above which sound fed back to the effect will be cut. If you do not want to cut the high frequencies, set this parameter to BYPASS.
Delay Balance #	D100:0W-D0:100W	Adjusts the volume balance between the sound that is sent through the delay (W) and the sound that is not sent through the delay (D).
Level	0-127	Output Level

75: CHORUS → DELAY

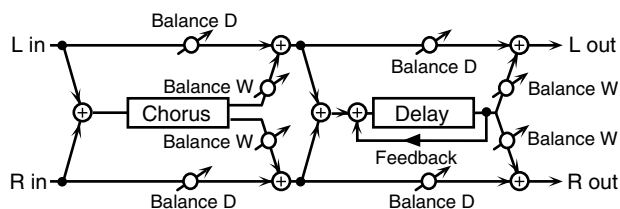

Parameter	Value	Description
Chorus Pre Delay	0.0-100.0 ms	Adjusts the delay time from the direct sound until the chorus sound is heard.
Chorus Rate #	0.05-10.00 Hz, note	Frequency of modulation
Chorus Depth	0-127	Depth of modulation
Chorus Balance #	D100:0W-D0:100W	Volume balance between the direct sound (D) and the chorus sound (W)
Delay Time	0-2600 ms, note	Adjusts the delay time from the direct sound until the delay sound is heard.
Delay Feedback #	-98- +98 %	Adjusts the proportion of the delay sound that is fed back into the effect. Negative (-) settings will invert the phase.
Delay HF Damp	200-8000 Hz, BYPASS	Adjusts the frequency above which sound fed back to the effect will be cut. If you do not want to cut the high frequencies, set this parameter to BYPASS.
Delay Balance #	D100:0W-D0:100W	Adjusts the volume balance between the sound that is sent through the delay (W) and the sound that is not sent through the delay (D).
Level	0-127	Output Level

76: FLANGER → DELAY

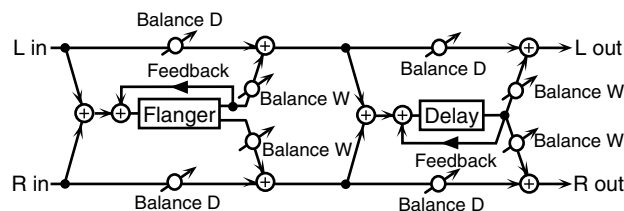

Parameter	Value	Description
Flanger Pre Delay	0.0-100.0 ms	Adjusts the delay time from when the direct sound begins until the flanger sound is heard.
Flanger Rate #	0.05-10.00 Hz, note	Frequency of modulation
Flanger Depth	0-127	Depth of modulation
Flanger Feedback #	-98- +98 %	Adjusts the proportion of the flanger sound that is fed back into the effect. Negative (-) settings will invert the phase.
Flanger Balance #	D100:0W-D0:100W	Volume balance between the direct sound (D) and the flanger sound (W)
Delay Time	0-2600 ms, note	Adjusts the delay time from the direct sound until the delay sound is heard.
Delay Feedback #	-98- +98 %	Adjusts the proportion of the delay sound that is fed back into the effect. Negative (-) settings will invert the phase.
Delay HF Damp	200-8000 Hz, BYPASS	Adjusts the frequency above which sound fed back to the effect will be cut. If you do not want to cut the high frequencies, set this parameter to BYPASS.
Delay Balance #	D100:0W-D0:100W	Adjusts the volume balance between the sound that is sent through the delay (W) and the sound that is not sent through the delay (D).
Level	0-127	Output Level

Effects List

77: CHORUS → FLANGER

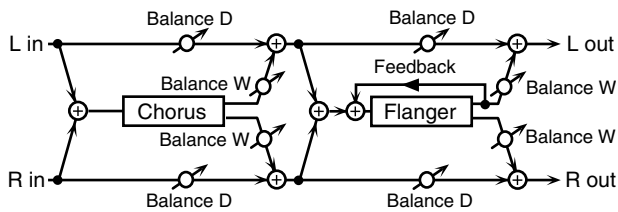

Parameter	Value	Description
Chorus Pre Delay	0.0–100.0 ms	Adjusts the delay time from the direct sound until the chorus sound is heard.
Chorus Rate #	0.05–10.00 Hz, note	Modulation frequency of the chorus effect
Chorus Depth	0–127	Modulation depth of the chorus effect
Chorus Balance #	D100:0W–D0:100W	Volume balance between the direct sound (D) and the chorus sound (W)
Flanger Pre Delay	0.0–100.0 ms	Adjusts the delay time from when the direct sound begins until the flanger sound is heard.
Flanger Rate #	0.05–10.00 Hz, note	Modulation frequency of the flanger effect
Flanger Depth	0–127	Modulation depth of the flanger effect
Flanger Feedback #	-98– +98 %	Adjusts the proportion of the flanger sound that is fed back into the effect. Negative (-) settings will invert the phase.
Flanger Balance #	D100:0W–D0:100W	Adjusts the volume balance between the sound that is sent through the flanger (W) and the sound that is not sent through the flanger (D).
Level	0–127	Output Level

78: SYMPATHETIC RESONANCE

On an acoustic piano, holding down the damper pedal allows other strings to resonate in sympathy with the notes you play, creating rich and spacious resonances. This effect simulates these sympathetic resonances.

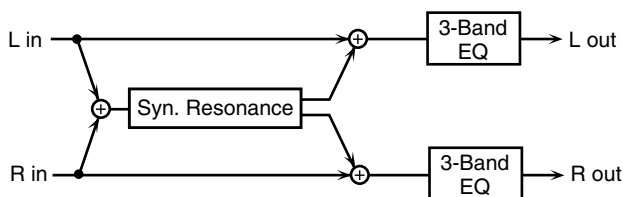

Parameter	Range	Explanation
Depth #	0–127	Depth of the effect
Damper #	0–127	Depth to which the damper pedal is pressed (controls the resonant sound)
Pre LPF	16–15000 Hz, BYPASS	Frequency of the filter that cuts the high-frequency content of the input sound (BYPASS: no cut)
Pre HPF	BYPASS, 16–15000 Hz	Frequency of the filter that cuts the low-frequency content of the input sound (BYPASS: no cut)
Peaking Freq	200–8000 Hz	Frequency of the filter that boosts/cuts a specific frequency region of the input sound
Peaking Gain	-15– +15 dB	Amount of boost/cut produced by the filter at the specified frequency region of the input sound

Parameter	Range	Explanation
Peaking Q	0.5, 1.0, 2.0, 4.0, 8.0	Width of the frequency region boosted/cut by the 'Peaking Gain' parameter (larger values make the region narrower)
HF Damp	16–15000 Hz, BYPASS	Frequency at which the high-frequency content of the resonant sound will be cut (BYPASS: no cut)
LF Damp	BYPASS, 16–15000 Hz	Frequency at which the low-frequency content of the resonant sound will be cut (BYPASS: no cut)
Lid	1–6	This simulates the actual changes in sound that occur when the lid of a grand piano is set at different heights.
EQ Low Freq	200, 400 Hz	Frequency of the low-range EQ
EQ Low Gain	-15– +15 dB	Amount of low-range boost/cut
EQ Mid Freq	200–8000 Hz	Frequency of the midrange EQ
EQ Mid Gain	-15– +15 dB	Amount of midrange boost/cut
EQ Mid Q	0.5, 1.0, 2.0, 4.0, 8.0	Width of midrange (larger values make the region narrower)
EQ High Freq	2000, 4000, 8000 Hz	Frequency of the high-range EQ
EQ High Gain	-15– +15 dB	Amount of high-range boost/cut
Level	0–127	Output Level

When Using 3D Effects

The following 3D effects utilize RSS (Roland Sound Space) technology to create a spaciousness that cannot be produced by delay, reverb, chorus, etc.

52: 3D DELAY

29: 3D CHORUS

30: 3D FLANGER

31: 3D STEP FLANGER

When using these effects, we recommend that you place your speakers as follows. Also, make sure that the speakers are at a sufficient distance from the walls on either side.

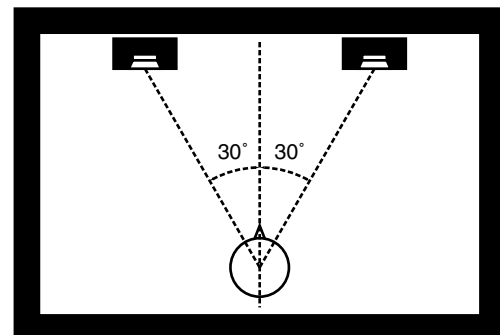

If the left and right speakers are too far apart, or if there is too much reverberation, the full 3D effect may not appear. Each of these effects has an "Output Mode" parameter. If the sound from the OUTPUT jacks is to be heard through speakers, set this parameter to "SPEAKER." If the sound is to be heard through headphones, set it to "PHONES." This will ensure that the optimal 3D effect will be heard. If this parameter is not set correctly, the full 3D effect may not appear.

About the STEP RESET function

- 06: STEP FILTER
- 16: STEP RING MODULATOR
- 19: STEP PAN
- 20: SLICER
- 63: STEP PITCH SHIFTER

The above five types contain a sixteen-step sequencer. For these types, you can use a multi-effect control to reset the sequence to play from the first step. To do this, set the multi-effect control Destination to "Step Reset."

For example if you are using the modulation lever to control the effect, you would make the following settings.

Source: CC01: MODULATION

Destination: Step Reset

Sens: +63

With these settings, the sequence will play back from the first step whenever you operate the modulation lever.

note:

- (Sixty-fourth-note triplet), (Sixty-fourth note), (Thirty-second-note triplet), (Thirty-second note), (Sixteenth-note triplet), (Dotted thirty-second note), (Sixteenth note), (Eighth-note triplet), (Dotted sixteenth note), (Eighth note), (Quarter-note triplet), (Dotted eighth note), (Quarter note), (Half-note triplet), (Dotted quarter note), (Half note), (Whole-note triplet), (Dotted half note), (Whole note), (Double-note triplet), (Dotted whole note), (Double note)

Chorus Parameters

The Phantom-X's Chorus effect unit can also be used as a stereo delay unit.

These settings allow you to select chorus or delay, and the characteristics of the selected effect type.

Parameter	Value	Description
Chorus Type	0 (OFF), 1 (CHORUS), 2 (DELAY), 3 (GM2 CHORUS)	Selects either Chorus or Delay. 0 (OFF): Neither Chorus or Delay is used. 1 (CHORUS): Chorus is used. 2 (DELAY): Delay is used. 3 (GM2 CHORUS): GM2 Chorus is used.
Type: 1 (CHORUS)		
Rate	0.05–10.00 Hz, note	Frequency of modulation
Depth	0–127	Depth of modulation
Pre Delay	0.0–100.0 ms	Adjusts the delay time from the direct sound until the chorus sound is heard.
Feedback	0–127	Adjusts the amount of the chorus sound that is fed back into the effect.
Filter Type	OFF, LPF, HPF	Type of filter OFF: no filter is used LPF: cuts the frequency range above the Cutoff Freq HPF: cuts the frequency range below the Cutoff Freq
Cutoff Freq	200–8000 Hz	Basic frequency of the filter
Phase	0–180°	Spatial spread of the sound
Type: 2 (DELAY)		
Delay Left	0–1000 ms, note	Adjusts the delay time from the direct sound until the delay sound is heard.
Delay Right		
Delay Center		
Center Feedback	-98+98 %	Adjusts the proportion of the delay sound that is fed back into the effect. Negative (-) settings will invert the phase.
HF Damp	200–8000 Hz, BYPASS	Adjusts the frequency above which sound fed back to the effect will be cut. If you do not want to cut the high frequencies, set this parameter to BYPASS.
Left Level	0–127	Volume of each delay sound
Right Level		
Center Level		
Type: 3 (GM2 CHORUS)		
Pre-LPF	0–7	Cuts the high frequency range of the sound coming into the chorus. Higher values will cut more of the high frequencies.
Level	0–127	Volume of the chorus sound
Feedback	0–127	Adjusts the amount of the chorus sound that is fed back into the effect.
Delay	0–127	Adjusts the delay time from the direct sound until the chorus sound is heard.
Rate	0–127	Frequency of modulation
Depth	0–127	Depth of modulation
Send Level To Reverb	0–127	Adjusts the amount of chorus sound that will be sent to the reverb.

note:

- (Sixty-fourth-note triplet), (Sixty-fourth note), (Thirty-second-note triplet), (Thirty-second note), (Sixteenth-note triplet), (Dotted thirty-second note), (Sixteenth note), (Eighth-note triplet), (Dotted sixteenth note), (Eighth note), (Quarter-note triplet), (Dotted eighth note), (Quarter note), (Half-note triplet), (Dotted quarter note), (Half note), (Whole-note triplet), (Dotted half note), (Whole note), (Double-note triplet), (Dotted whole note), (Double note)

Effects List

Reverb Parameters

These settings allow you to select the desired type of reverb, and its characteristics.

Parameter	Value	Description
Reverb Type	0 (OFF), 1 (REVERB), 2 (SRV ROOM), 3 (SRV HALL), 4 (SRV PLATE), 5 (GM2 REVERB)	Type of reverb 0 (OFF): Reverb is not used. 1 (REVERB): Normal reverb 2 (SRV ROOM): This simulates typical room acoustic reflections. 3 (SRV HALL): This simulates typical concert hall acoustic reflections. 4 (SRV PLATE): This simulates a reverb plate, a popular type of artificial reverb unit that derives its sound from the vibration of a metallic plate. 5 (GM2 REVERB): GM2 Reverb
Type: 1 (REVERB)		
Type	ROOM1, ROOM2, STAGE1, STAGE2, HALL1, HALL2, DELAY, PAN-DELAY	Type of reverb/delay ROOM1: short reverb with high density ROOM2: short reverb with low density STAGE1: reverb with greater late reverberation STAGE2: reverb with strong early reflections HALL1: very clear-sounding reverb HALL2: rich reverb DELAY: conventional delay effect PAN-DELAY: delay effect with echoes that pan left and right
Time	0–127	Time length of reverberation (Type: ROOM1–HALL2) Delay time (Type: DELAY, PAN-DELAY)
HF Damp	200–8000 Hz, BYPASS	Adjusts the frequency above which the high-frequency content of the reverb sound will be cut, or “damped.” If you do not want to cut the high frequencies, set this parameter to BYPASS.
Delay Feedback	0–127	Adjusts the amount of delay feedback when the Type setting is DELAY or PAN-DELAY.
Type: 2 (SRV ROOM)/3 (SRV HALL)/4 (SRV PLATE)		
Pre Delay	0.0–100.0 ms	Adjusts the delay time from the direct sound until the reverb sound is heard.
Time	0–127	Time length of reverberation
Size	1–8	Size of the simulated room or hall
High Cut	160 Hz–12.5 kHz, BYPASS	Adjusts the frequency above which the high-frequency content of the reverb will be reduced. If you do not want to reduce the high frequencies, set this parameter to BYPASS.
Density	0–127	Density of reverb
Diffusion	0–127	Adjusts the change in the density of the reverb over time. The higher the value, the more the density increases with time. (The effect of this setting is most pronounced with long reverb times.)
LF Damp Freq	50–4000 Hz	Adjusts the frequency below which the low-frequency content of the reverb sound will be reduced, or “damped.”
LF Damp Gain	-36–0 dB	Adjusts the amount of damping applied to the frequency range selected with LF Damp. With a setting of “0,” there will be no reduction of the reverb’s low-frequency content.
HF Damp Freq	4000 Hz–12.5 kHz	Adjusts the frequency above which the high-frequency content of the reverb sound will be reduced, or “damped.”
HF Damp Gain	-36–0 dB	Adjusts the amount of damping applied to the frequency range selected with HF Damp. With a setting of “0,” there will be no reduction of the reverb’s high-frequency content.
Type: 5 (GM2 REVERB)		
Character	0–7	Type of reverb 0–5: reverb 6, 7: delay
Pre-LPF	0–7	Cuts the high frequency range of the sound coming into the reverb. Higher values will cut more of the high frequencies.
Level	0–127	Output level of reverberation
Time	0–127	Time length of reverberation
Delay Feedback	0–127	Adjusts the amount of the delay sound that is fed back into the effect when the Reverb Character setting is 6 or 7.

Input Effect Parameters

Selects the type of effect that will be applied to the external input source.

01: EQUALIZER

Adjusts the tone of the low-frequency and high-frequency ranges.

Parameter	Range	Explanation
Low Freq	200, 400 Hz	Center frequency of the low-frequency range
Low Gain	-15–+15 dB	Amount of low-frequency boost/cut
High Freq	2000, 4000, 8000 Hz	Center frequency of the high-frequency range
High Gain	-15–+15 dB	Amount of high-frequency boost/cut

02: ENHANCER

Modifies the harmonic content of the high-frequency range to add sparkle to the sound.

Parameter	Range	Explanation
Sens	0–127	Depth of the enhancer effect
Mix	0–127	Volume of the harmonics that are generated

03: COMPRESSOR

Restraints high levels and boosts low levels to make the overall volume more consistent.

Parameter	Range	Explanation
Attack	0–127	Time from when the input exceeds the Threshold until the volume begins to be compressed
Threshold	0–127	Volume level at which compression will begin
Post Gain	0–+18 dB	Level of the output sound

04: LIMITER

Compresses the sound when it exceeds a specified volume, to keep distortion from occurring.

Parameter	Range	Explanation
Release	0–127	Time from when the input falls below the Threshold until compression ceases
Threshold	0–127	Volume level at which compression will begin
Post Gain	0–+18 dB	Level of the output sound

05: NOISE SUPPRESSOR

Suppresses noise during periods of silence.

Parameter	Range	Explanation
Threshold	0-127	Volume at which noise suppression will begin
Release	0-127	Time from when noise suppression begins until the volume reaches zero.

06: CENTER CANCELER

Removes the sounds that are localized at the center of the stereo input. This is a convenient way to eliminate a vocal.

Parameter	Range	Explanation
Ch Balance	-50- +50	Volume balance of the L (left) and R (right) channels for removing the sound
Range Low	16-15000 Hz	Lower frequency limit of the band to be removed
Range High	16-15000 Hz1	Upper frequency limit of the band to be removed

Error Messages

If an incorrect operation is performed, or if processing could not be performed as you specified, an error message will appear. Refer to the explanation for the error message that appears, and take the appropriate action.

Message	Meaning	Action
Cannot Edit Preset Sample!	This is a preset sample, and therefore cannot be edited.	—
Card Not Ready!	A memory card is not inserted in the slot.	Insert a memory card into the slot.
Data not found	The data for placement is not specified.	—
Empty Pattern	The Pattern has no data in it, so the Pattern Call message cannot be recorded in Step Recording.	—
Empty Sample!	The sample contains no data.	Select a sample that contains data.
Empty Song!	The song has not been recorded, and therefore cannot be played.	Select a song that contains data.
File Name Duplicate	A file with the same name already exists.	Delete the file bearing the same name from the disk, and if overwriting and saving the data, merely save the file. If you do not want to delete the file with the same name from the disk, either save the file with a different name.
Illegal File!	The Fantom-X cannot use this file.	—
Memory Damaged!	The contents of memory may have been damaged.	Please perform the Factory Reset operation. If this does not resolve the problem, please contact your dealer or the nearest Roland Service Center.
Memory Full!	Saving is not possible because there is insufficient space in the user area or memory card.	Delete unneeded data.
MIDI Offline!	There is a problem with the MIDI cable connection.	Check that the MIDI cable has not been disconnected or broken.
No More Note Numbers!	A maximum of 16 different note numbers can be used in one style of the arpeggio/rhythm function.	Please delete unneeded notes.
No More Sample Numbers!	The sample cannot be divided any further. Since fewer than 256 consecutive sample numbers are vacant, no further sampling is possible.	Erase unneeded samples in order to allocate 256 or more consecutive sample numbers.
No More Song Numbers!	No more songs can be saved. A maximum of 256 songs can be handled simultaneously for both the user bank and card bank.	Please delete unneeded songs.
Now Playing!	Since the Fantom-X is playing, this operation cannot be executed.	Stop playback before you execute the operation.
Permission Denied!	The file is protected.	—
Playback Tempo Range Over	Tempo values exceed the allowable limit, and data is created in which the closest time available within the allowable range is specified.	—
Recording Parameter Error	You are attempting to begin recording after a looped segment.	You are attempting to begin recording within or before a looped segment.
Rec Over Flow	Since a large amount of recorded data was input all at once, it could not be processed correctly.	Reduce the amount of recorded data.
Sample Length Too Short!	The sample is too short, and cannot be edited correctly.	If the sample is extremely short, editing may not produce the desired result.
Sample Memory Full!	Since there is insufficient sample memory, no further sampling or sample editing is possible.	Erase unneeded samples.
Song Full	Since the maximum number of notes that can be recorded in a song or pattern has been exceeded, no further recording/editing is possible.	Use the track edit Delete or Erase commands to remove unneeded data from the song/pattern that you are recording/editing.
Song Format Error	This song is damaged.	This song cannot be used.
Song Not Found	The selected song cannot be found.	—
Too Many Sample Selected!	The operation cannot be executed, since marks are assigned to more than one sample.	Either clear the marks, or mark only one sample.
Unformatted!	The memory card is in an unsupported format.	Format the memory card.
You Cannot Assign	The sample cannot be assigned to a pad.	Assign To Pad requires that all pads be playing a rhythm set. Assign a rhythm set to the Pad part. Turn off the RPS function. Turn off the rhythm switch. Turn off the ARPEGGIO/RHYTHM function.
You Cannot Copy This Message	This message cannot be copied.	—
You Cannot Erase This Message	This message cannot be erased.	—
You Cannot Move This Message	This message cannot be moved.	—
You Cannot Quick Play S-MRC Song	This is a SuperMRC song; it cannot be played back in Quick Play.	Save the data as an MRC Pro song.
Rhythm Note Range Over!	The pad selected for Assign To Pad is outside the range of the rhythm set.	Select a pad that is within the range of the rhythm set.

About MIDI

MIDI (Musical Instruments Digital Interface) is a standard specification that allows musical data to be exchanged between electronic musical instruments and computers. With a MIDI cable connecting MIDI devices that are equipped with MIDI connectors, you can play multiple instruments with a single keyboard, have multiple MIDI instruments perform in ensemble, program the settings to change automatically to match the performance as the song progresses, and more.

If you mainly use the Fantom-X as a standalone keyboard instrument, you may really not need to know much at all about MIDI.

However, the following MIDI-related information is provided so you can play the Fantom-X using an external MIDI device, or master other advanced techniques.

About MIDI Connectors

The Fantom-X is equipped with the three types of MIDI connectors, each which works differently.



MIDI IN Connector

This connector receives MIDI messages that are transmitted from external MIDI devices. The Fantom-X can receive these messages to play notes or select sounds, etc.

MIDI OUT Connector

This connector transmits MIDI messages to external MIDI devices. The Fantom-X's MIDI OUT connector is used for sending the performance data of the keyboard controller section as well as data used for saving various settings and patterns.

MIDI THRU Connector

MIDI messages received at MIDI IN are re-transmitted without change from this connector to an external MIDI device. Use this in situations such as when you use multiple MIDI devices simultaneously.

MIDI Channels and Multi-timbral Sound Generators

MIDI transmits many types of data over a single MIDI cable. This is made possible by the concept of **MIDI channels**. MIDI channels allow messages intended for a given instrument to be distinguished from messages intended for another instrument. In some ways, MIDI channels are similar to television channels. By changing the channel on a television set, you can view the programs that are being broadcast by different stations. In the same way, MIDI also allows a device to select the information intended for that device out of the variety of information that is being transmitted to it.

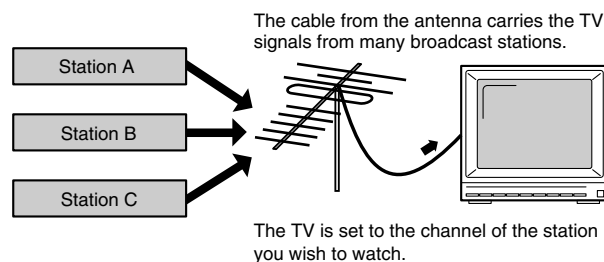

MIDI uses sixteen channels; 1 through 16. Set the receiving device so that it will receive only the channel that it needs to receive.

Example:

Set the Fantom-X to send Channel 1 and Channel 2, then set sound module A to receive only Channel 1 and sound module B only Channel 2. With this setup, you can get an ensemble performance, with, for example, a guitar sound from sound module A and bass from sound module B.

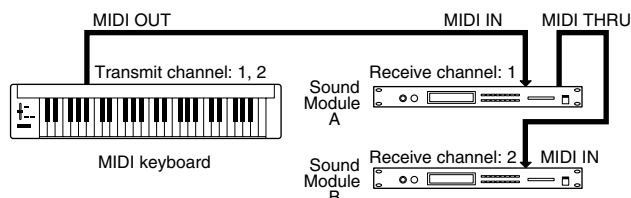

When used as a sound module, the Fantom-X can receive on up to sixteen MIDI channels. Sound modules like the Fantom-X which can receive multiple MIDI channels simultaneously to play different sounds on each channel are called **multi-timbral sound modules**.

General MIDI

General MIDI is a set of recommendations which seeks to provide a way to go beyond the limitations of proprietary designs, and standardize the MIDI capabilities of sound generating devices. Sound generating devices and music files that meet the General MIDI standard bear the General MIDI logo (). Music files bearing the General MIDI logo can be played back using any General MIDI sound generating unit to produce essentially the same musical performance.

General MIDI 2

The upwardly compatible General MIDI 2 () recommendations pick up where the original General MIDI left off, offering enhanced expressive capabilities, and even greater compatibility. Issues that were not covered by the original General MIDI recommendations, such as how sounds are to be edited, and how effects should be handled, have now been precisely defined. Moreover, the available sounds have been expanded. General MIDI 2 compliant sound generators are capable of reliably playing back music files that carry either the General MIDI or General MIDI 2 logo.

In some cases, the conventional form of General MIDI, which does not include the new enhancements, is referred to as "General MIDI 1" as a way of distinguishing it from General MIDI 2.

MIDI Implementation

1. Receive Data (Sound Source Section)

■ Channel Voice Messages

* Not received in Performance mode when the Receive Switch parameter (PERFORM/MIDI) is OFF.

● Note off

Status	2nd byte	3rd byte
8nH	kkH	vvH
9nH	kkH	00H
n = MIDI channel number:	0H - FH (ch.1 - 16)	
kk = note number:	00H - 7FH (0 - 127)	
vv = note off velocity:	00H - 7FH (0 - 127)	

* Not received when the Envelope Mode parameter (PATCH/MISC and RHYTHM/GENERAL) is NO-SUS.

● Note on

Status	2nd byte	3rd byte
9nH	kkH	vvH
n = MIDI channel number:	0H - FH (ch.1 - 16)	
kk = note number:	00H - 7FH (0 - 127)	
vv = note on velocity:	01H - 7FH (1 - 127)	

● Polyphonic Key Pressure

Status	2nd byte	3rd byte
AnH	kkH	vvH
n = MIDI channel number:	0H - FH (ch.1 - 16)	
kk = note number:	00H - 7FH (0 - 127)	
vv = Polyphonic Key Pressure:	00H - 7FH (0 - 127)	

* Not received in Performance mode when the Receive Poly Key Pressure parameter (PERFORM/MIDI) is OFF.

● Control Change

- * If the corresponding Controller number is selected for the Patch Control Source 1, 2, 3 or 4 parameter (PATCH/CTRL1-4), the corresponding effect will occur.
- * If a Controller number that corresponds to the System Control Source 1, 2, 3 or 4 parameter (SYSTEM/SYSTEM CONTROL) is selected, the specified effect will apply if Patch Control Source 1, 2, 3 or 4 parameter (PATCH/CTRL1-4) is set to SYS-CTRL1, SYS-CTRL2, SYS-CTRL3 or SYS-CTRL4.

○ Bank Select (Controller number 0, 32)

Status	2nd byte	3rd byte
BnH	00H	mmH
BnH	20H	llH
n = MIDI channel number:	0H - FH (ch.1 - 16)	
mm, ll = Bank number:	00 00H - 7F 7FH (bank.1 - bank.16384)	

- * Not received in Performance mode when the Receive Bank Select (PERFORM/MIDI) is OFF.
- * The Performances, Patches, and Rhythms corresponding to each Bank Select are as follows.
- * The SRX series corresponding to each Bank Select are to see the SRX series owner's manual.

BANK	SELECT	PROGRAM	GROUP	NUMBER
MSB	LSB	NUMBER		
000	:	001 - 128	GM Patch	001 - 256
063	:	001 - 128	GM Patch	001 - 256
085	000	001 - 064	User Performance	001 - 064
	032	001 - 064	Card Performance	001 - 064
	064	001 - 064	Preset Performance	001 - 064
086	000	001 - 032	User Rhythm	001 - 032
	032	001 - 032	Card Rhythm	001 - 032
	064	001 - 032	Preset Rhythm	001 - 032
087	000	001 - 128	User Patch	001 - 128
	001	001 - 128	User Patch	129 - 256
	032	001 - 128	Card Patch	001 - 128
	033	001 - 128	Card Patch	129 - 256
	064	001 - 128	Preset Patch A	001 - 128
	065	001 - 128	Preset Patch B	001 - 128
	:	:	:	:
092	000 -	001 -	SRX Rhythm	001 -
	:	:	:	:
093	000 -	001 -	SRX Patch	001 -
	:	:	:	:
120	:	001 - 057	GM Rhythm	001 - 009
121	000 -	001 - 128	GM Patch	001 - 256

○ Modulation (Controller number 1)

Status	2nd byte	3rd byte
BnH	01H	vvH
n = MIDI channel number:	0H - FH (ch.1 - 16)	
vv = Modulation depth:	00H - 7FH (0 - 127)	

* Not received in Performance mode when the Receive Modulation parameter (PERFORM/MIDI) is OFF.

○ Breath type (Controller number 2)

Status	2nd byte	3rd byte
BnH	02H	vvH
n = MIDI channel number:	0H - FH (ch.1 - 16)	
vv = Control value:	00H - 7FH (0 - 127)	

○ Foot type (Controller number 4)

Status	2nd byte	3rd byte
BnH	04H	vvH
n = MIDI channel number:	0H - FH (ch.1 - 16)	
vv = Control value:	00H - 7FH (0 - 127)	

○ Portamento Time (Controller number 5)

Status	2nd byte	3rd byte
BnH	05H	vvH
n = MIDI channel number:	0H - FH (ch.1 - 16)	
vv = Portamento Time:	00H - 7FH (0 - 127)	

* In Performance mode the Part Portament Time parameter (PERFORM/PART) will change.

○ Data Entry (Controller number 6, 38)

Status	2nd byte	3rd byte
BnH	06H	mmH
BnH	26H	llH
n = MIDI channel number:	0H - FH (ch.1 - 16)	
mm, ll = the value of the parameter specified by RPN/NRPN		
mm = MSB, ll = LSB		

○ Volume (Controller number 7)

Status	2nd byte	3rd byte
BnH	07H	vvH
n = MIDI channel number:	0H - FH (ch.1 - 16)	
vv = Volume:	00H - 7FH (0 - 127)	

* Not received in Performance mode when the Receive Volume parameter (PERFORM/MIDI) is OFF.

* In Performance mode the Part Level parameter (PERFORM/PART) will change.

○ Balance (Controller number 8)

Status	2nd byte	3rd byte
BnH	08H	vvH
n = MIDI channel number:	0H - FH (ch.1 - 16)	
vv = Balance:	00H - 7FH (0 - 127)	

○ Panpot (Controller number 10)

Status	2nd byte	3rd byte
BnH	0AH	vvH
n = MIDI channel number:	0H - FH (ch.1 - 16)	
vv = Panpot:	00H - 40H - 7FH (Left - Center - Right),	

* Not received in Performance mode when the Receive Pan parameter (PERFORM/MIDI) is OFF.

* In Performance mode the Part Pan parameter (PERFORM/PART) will change.

○ Expression (Controller number 11)

Status	2nd byte	3rd byte
BnH	0BH	vvH
n = MIDI channel number:	0H - FH (ch.1 - 16)	
vv = Expression:	00H - 7FH (0 - 127)	

* Not received when Tone Receive Expression parameter (PATCH/MISC or RHYTHM/GENERAL) is OFF.

* Not received in Performance mode when Receive Expression parameter (PERFORM/MIDI) is OFF.

○Hold 1 (Controller number 64)

Status	2nd byte	3rd byte
BnH	40H	vvH
n = MIDI channel number:	0H - FH (ch.1 - 16)	
vv = Control value:	00H - 7FH (0 - 127) 0-63 = OFF, 64-127 = ON	

- * Not received when Tone Receive Hold-1 parameter (PATCH/MISC or RHYTHM/GENERAL) is OFF.
- * Not received in Performance mode when Receive Hold-1 parameter (PERFORM/MIDI) is OFF.
- * When the Tone Redamper Switch parameter (PATCH/CONTROL) is turned ON, 128 discrete steps are recognized for the value.

○Portamento (Controller number 65)

Status	2nd byte	3rd byte
BnH	41H	vvH
n = MIDI channel number:	0H - FH (ch.1 - 16)	
vv = Control value:	00H - 7FH (0 - 127) 0 - 63 = OFF, 64 - 127 = ON	

- * In Performance mode the Part Portamento Switch parameter (PERFORM/PART) will change.

○Sostenuto (Controller number 66)

Status	2nd byte	3rd byte
BnH	42H	vvH
n = MIDI channel number:	0H - FH (ch.1 - 16)	
vv = Control value:	00H - 7FH (0 - 127) 0 - 63 = OFF, 64 - 127 = ON	

○Soft (Controller number 67)

Status	2nd byte	3rd byte
BnH	43H	vvH
n = MIDI channel number:	0H - FH (ch.1 - 16)	
vv = Control value:	00H - 7FH (0 - 127) 0 - 63 = OFF, 64 - 127 = ON	

○Legato Foot Switch (Controller number 68)

Status	2nd byte	3rd byte
BnH	44H	vvH
n = MIDI channel number:	0H - FH (ch.1 - 16)	
vv = Control value:	00H - 7FH (0 - 127) 0 - 63 = OFF, 64 - 127 = ON	

- * In Performance mode the Part Legato Switch parameter (PERFORM/PART) will change.

○Hold-2 (Controller number 69)

Status	2nd byte	3rd byte
BnH	45H	vvH
n = MIDI channel number:	0H - FH (ch.1 - 16)	
vv = Control value:	00H - 7FH (0 - 127)	

- * A hold movement isn't done.

○Resonance (Controller number 71)

Status	2nd byte	3rd byte
BnH	47H	vvH
n = MIDI channel number:	0H - FH (ch.1 - 16)	
vv = Resonance value (relative change):	00H - 40H - 7FH (-64 - 0 + 63),	

- * In Performance mode the Part Resonance Offset parameter (PERFORM/PART) will change.

○Release Time (Controller number 72)

Status	2nd byte	3rd byte
BnH	48H	vvH
n = MIDI channel number:	0H - FH (ch.1 - 16)	
vv = Release Time value (relative change):	00H - 40H - 7FH (-64 - 0 + 63),	

- * In Performance mode the Part Release Time Offset parameter (PERFORM/PART) will change.

○Attack time (Controller number 73)

Status	2nd byte	3rd byte
BnH	49H	vvH
n = MIDI channel number:	0H - FH (ch.1 - 16)	
vv = Attack time value (relative change):	00H - 40H - 7FH (-64 - 0 + 63),	

- * In Performance mode the Part Attack Time Offset parameter (PERFORM/PART) will change.

○Cutoff (Controller number 74)

Status	2nd byte	3rd byte
BnH	4AH	vvH
n = MIDI channel number:	0H - FH (ch.1 - 16)	
vv = Cutoff value (relative change):	00H - 40H - 7FH (-64 - 0 + 63)	

- * In Performance mode the Part Cutoff Offset parameter (PERFORM/PART) will change.

○Decay Time (Controller number 75)

Status	2nd byte	3rd byte
BnH	4BH	vvH
n = MIDI channel number:	0H - FH (ch.1 - 16)	
vv = Decay Time value (relative change):	00H - 40H - 7FH (-64 - 0 + 63)	

- * In Performance mode the Part Decay Time Offset parameter (PERFORM/PART) will change.

○Vibrato Rate (Controller number 76)

Status	2nd byte	3rd byte
BnH	4CH	vvH
n = MIDI channel number:	0H - FH (ch.1 - 16)	
vv = Vibrato Rate value (relative change):	00H - 40H - 7FH (-64 - 0 + 63)	

- * In Performance mode the Part Vibrato Rate parameter (PERFORM/PART) will change.

○Vibrato Depth (Controller number 77)

Status	2nd byte	3rd byte
BnH	4DH	vvH
n = MIDI channel number:	0H - FH (ch.1 - 16)	
vv = Vibrato Depth Value (relative change):	00H - 40H - 7FH (-64 - 0 + 63)	

- * In Performance mode the Part Vibrato Depth parameter (PERFORM/PART) will change.

○Vibrato Delay (Controller number 78)

Status	2nd byte	3rd byte
BnH	4EH	vvH
n = MIDI channel number:	0H - FH (ch.1 - 16)	
vv = Vibrato Delay value (relative change):	00H - 40H - 7FH (-64 - 0 + 63)	

- * In Performance mode the Part Vibrato Delay parameter (PERFORM/PART) will change.

○General Purpose Controller 5 (Controller number 80)

Status	2nd byte	3rd byte
BnH	50H	vvH
n = MIDI channel number:	0H - FH (ch.1 - 16)	
vv = Control value:	00H - 7FH (0 - 127)	

- * The Tone Level parameter (PATCH/TVA) of Tone 1 will change.

○General Purpose Controller 6 (Controller number 81)

Status	2nd byte	3rd byte
BnH	51H	vvH
n = MIDI channel number:	0H - FH (ch.1 - 16)	
vv = Control value:	00H - 7FH (0 - 127)	

- * The Tone Level parameter (PATCH/TVA) of Tone 2 will change.

○General Purpose Controller 7 (Controller number 82)

Status	2nd byte	3rd byte
BnH	52H	vvH
n = MIDI channel number:	0H - FH (ch.1 - 16)	
vv = Control value:	00H - 7FH (0 - 127)	

- * The Tone Level parameter (PATCH/TVA) of Tone 3 will change.

○General Purpose Controller 8 (Controller number 83)

Status	2nd byte	3rd byte
BnH	53H	vvH
n = MIDI channel number:	0H - FH (ch.1 - 16)	
vv = Control value:	00H - 7FH (0 - 127)	

- * The Tone Level parameter (PATCH/TVA) of Tone 4 will change.

MIDI Implementation

○Portamento control (Controller number 84)

<u>Status</u>	<u>2nd byte</u>	<u>3rd byte</u>
BnH	54H	kkH
n = MIDI channel number:	0H - FH (ch.1 - 16)	
kk = source note number:	00H - 7FH (0 - 127)	

- * A Note-on received immediately after a Portamento Control message will change continuously in pitch, starting from the pitch of the Source Note Number.
- * If a voice is already sounding for a note number identical to the Source Note Number, this voice will continue sounding (i.e., legato) and will, when the next Note-on is received, smoothly change to the pitch of that Note-on.
- * The rate of the pitch change caused by Portamento Control is determined by the Portamento Time value.

○Effect 1 (Reverb Send Level) (Controller number 91)

<u>Status</u>	<u>2nd byte</u>	<u>3rd byte</u>
BnH	5BH	vvH
n = MIDI channel number:	0H - FH (ch.1 - 16)	
vv = Reverb Send Level:	00H - 7FH (0 - 127)	

- * In Performance mode the Part Reverb Send Level parameter (PERFORM/PART) will change.

○Effect 3 (Chorus Send Level) (Controller number 93)

<u>Status</u>	<u>2nd byte</u>	<u>3rd byte</u>
BnH	5DH	vvH
n = MIDI channel number:	0H - FH (ch.1 - 16)	
vv = Chorus Send Level:	00H - 7FH (0 - 127)	

- * In Performance mode the Part Chorus Send Level parameter (PERFORM/PART) will change.

○RPN MSB/LSB (Controller number 100, 101)

<u>Status</u>	<u>2nd byte</u>	<u>3rd byte</u>
BnH	65H	mmH
BnH	64H	llH
n = MIDI channel number:	0H - FH (ch.1 - 16)	
mm = upper byte (MSB) of parameter number specified by RPN		
ll = lower byte (LSB) of parameter number specified by RPN		

<<< RPN >>>

Control Changes include RPN (Registered Parameter Numbers), which are extended. When using RPNs, first RPN (Controller numbers 100 and 101; they can be sent in any order) should be sent in order to select the parameter, then Data Entry (Controller numbers 6 and 38) should be sent to set the value. Once RPN messages are received, Data Entry messages that is received at the same MIDI channel after that are recognized as changing toward the value of the RPN messages. In order not to make any mistakes, transmitting RPN Null is recommended after setting parameters you need.

This device receives the following RPNs.

RPN	Data entry	Notes
<u>MSB, LSB</u>	<u>MSB, LSB</u>	
00H, 00H	mmH, llH	Pitch Bend Sensitivity mm: 00H - 18H (0 - 24 semitones) ll: ignored (processed as 00H) Up to 2 octave can be specified in semitone steps.
* In Performance mode, the Part Bend Range parameter (PERFORM/PART) will change.		
00H, 01H	mmH, llH	Channel Fine Tuning mm, ll: 20 00H - 40 00H - 60 00H (-4096 x 100 / 8192 - 0 - +4096 x 100 / 8192 cent)
* In Performance mode, the Part Fine Tune parameter (PERFORM/PART) will change.		
00H, 02H	mmH, llH	Channel Coarse Tuning mm: 10H - 40H - 70H (-48 - 0 - +48 semitones) ll: ignored (processed as 00H)
* In Performance mode, the Part Coarse Tune parameter (PERFORM/PART) will change.		
00H, 05H	mmH, llH	Modulation Depth Range mm, ll: 00 00H - 00 06H (0 - 16384*600 / 16384 cent)
* Not received in Patch mode.		
7FH, 7FH	---, ---	RPN null RPN and NRPN will be set as "unspecified." Once this setting has been made, subsequent Parameter values that were previously set will not change. mm, ll: ignored

●Program Change

<u>Status</u>	<u>2nd byte</u>
CnH	ppH
n = MIDI channel number:	0H - FH (ch.1 - 16)
pp = Program number:	00H - 7FH (prog.1 - prog.128)

- * Not received in Performance mode when the Receive Program Change parameter (PERFORM/MIDI) is OFF.

●Channel Pressure

<u>Status</u>	<u>2nd byte</u>
DnH	vvH
n = MIDI channel number:	0H - FH (ch.1 - 16)
vv = Channel Pressure:	00H - 7FH (0 - 127)

- * Not received in Performance mode when the Receive Channel Pressure parameter (PERFORM/MIDI) is OFF.

●Pitch Bend Change

<u>Status</u>	<u>2nd byte</u>	<u>3rd byte</u>
EnH	llH	mmH
n = MIDI channel number:	0H - FH (ch.1 - 16)	
mm, ll = Pitch Bend value:	00 00H - 40 00H - 7F 7FH (-8192 - 0 - +8191)	

- * Not received when the Tone Receive Bender parameter (PATCH/MISC) is OFF.
- * Not received in Performance mode when the Receive Pitch Bend parameter (PERFORM/MIDI) is OFF.

■ Channel Mode Messages

* Not received in Performance mode when the Receive Switch parameter (PERFORM/MIDI) is OFF.

● All Sounds Off (Controller number 120)

Status	2nd byte	3rd byte
BnH	78H	00H

n = MIDI channel number: 0H - FH (ch.1 - 16)

* When this message is received, all notes currently sounding on the corresponding channel will be turned off.

● Reset All Controllers (Controller number 121)

Status	2nd byte	3rd byte
BnH	79H	00H

n = MIDI channel number: 0H - FH (ch.1 - 16)

* When this message is received, the following controllers will be set to their reset values.

Controller	Reset value
Pitch Bend Change	+/-0 (center)
Polyphonic Key Pressure	0 (off)
Channel Pressure	0 (off)
Modulation	0 (off)
Breath Type	0 (min)
Expression	127 (max)
	However the controller will be at minimum.
Hold 1	0 (off)
Sostenuto	0 (off)
Soft	0 (off)
Hold 2	0 (off)
RPN	unset; previously set data will not change
NRPN	unset; previously set data will not change

● All Notes Off (Controller number 123)

Status	2nd byte	3rd byte
BnH	7BH	00H

n = MIDI channel number: 0H - FH (ch.1 - 16)

* When All Notes Off is received, all notes on the corresponding channel will be turned off. However, if Hold 1 or Sostenuto is ON, the sound will be continued until these are turned off.

● OMNI OFF (Controller number 124)

Status	2nd byte	3rd byte
BnH	7CH	00H

n = MIDI channel number: 0H - FH (ch.1 - 16)

* The same processing will be carried out as when All Notes Off is received.

● OMNI ON (Controller number 125)

Status	2nd byte	3rd byte
BnH	7DH	00H

n = MIDI channel number: 0H - FH (ch.1 - 16)

* The same processing will be carried out as when All Notes Off is received. OMNI ON will not be turned on.

● MONO (Controller number 126)

Status	2nd byte	3rd byte
BnH	7EH	mmH

n = MIDI channel number: 0H - FH (ch.1 - 16)

mm = mono number: 00H - 10H (0 - 16)

* The same processing will be carried out as when All Notes Off is received.

* In Performance mode, the Part Mono/Poly parameter (PERFORM/PART) will change.

● POLY (Controller number 127)

Status	2nd byte	3rd byte
BnH	7FH	00H

n = MIDI channel number: 0H - FH (ch.1 - 16)

* The same processing will be carried out as when All Notes Off is received.

* In Performance mode, the Part Mono/Poly parameter (PERFORM/PART) will change.

■ System Realtime Message

● Active Sensing

Status

FEH

* When Active Sensing is received, the unit will begin monitoring the intervals of all further messages. While monitoring, if the interval between messages exceeds 420 ms, the same processing will be carried out as when All Sounds Off, All Notes Off and Reset All Controllers are received, and message interval monitoring will be halted.

■ System Exclusive Message

Status	Data byte	Status
F0H	iiH, ddH,eeH	F7H

F0H: System Exclusive Message status
 ii = ID number: an ID number (manufacturer ID) to indicate the manufacturer whose Exclusive message this is. Roland's manufacturer ID is 41H.
 ID numbers 7EH and 7FH are extensions of the MIDI standard; Universal Non-realtime Messages (7EH) and Universal Realtime Messages (7FH).
 dd,.....ee = data: 00H - 7FH (0 - 127)
 F7H: EOX (End Of Exclusive)

Of the System Exclusive messages received by this device, the Universal Non-realtime messages and the Universal Realtime messages and the Data Request (RQ1) messages and the Data Set (DT1) messages will be set automatically.

● Universal Non-realtime System Exclusive Messages

○ Identity Request Message

Status	Data byte	Status
F0H	7EH, dev, 06H, 01H	F7H

Byte	Explanation
F0H	Exclusive status
7EH	ID number (Universal Non-realtime Message)
dev	Device ID (dev: 10H - 1FH, 7FH)
06H	Sub ID#1 (General Information)
01H	Sub ID#2 (Identity Request)
F7H	EOX (End Of Exclusive)

* When this message is received, Identity Reply message (P.306) will be transmitted.

○ GM1 System On

Status	Data byte	Status
F0H	7EH, 7FH, 09H, 01H	F7H

Byte	Explanation
F0H	Exclusive status
7EH	ID number (Universal Non-realtime Message)
7FH	Device ID (Broadcast)
09H	Sub ID#1 (General MIDI Message)
01H	Sub ID#2 (General MIDI 1 On)
F7H	EOX (End Of Exclusive)

* When this messages is received, this instrument will turn to the Performance mode.

* Not received when the Receive GM1 System On parameter (SYSTEM/MIDI) is OFF.

○ GM2 System On

Status	Data byte	Status
F0H	7EH 7FH 09H 03H	F7H

Byte	Explanation
F0H	Exclusive status
7EH	ID number (Universal Non-realtime Message)
7FH	Device ID (Broadcast)
09H	Sub ID#1 (General MIDI Message)
03H	Sub ID#2 (General MIDI 2 On)
F7H	EOX (End Of Exclusive)

* When this messages is received, this instrument will turn to the Performance mode.

* Not received when the Receive GM2 System On parameter (SYSTEM/MIDI) is OFF.

MIDI Implementation

○GM System Off

Status	Data byte	Status
F0H	7EH, 7F, 09H, 02H	F7H

Byte	Explanation
F0H	Exclusive status
7EH	ID number (Universal Non-realtime Message)
7FH	Device ID (Broadcast)
09H	Sub ID#1 (General MIDI Message)
02H	Sub ID#2 (General MIDI Off)
F7H	EOX (End Of Exclusive)

* When this message is received, this instrument will return to the Performance mode.

●Universal Realtime System Exclusive Messages

○Master Volume

Status	Data byte	Status
F0H	7FH, 7FH, 04H, 01H, 11H, mmH	F7H

Byte	Explanation
F0H	Exclusive status
7FH	ID number (universal realtime message)
7FH	Device ID (Broadcast)
04H	Sub ID#1 (Device Control)
01H	Sub ID#2 (Master Volume)
11H	Master Volume lower byte
mmH	Master Volume upper byte
F7H	EOX (End Of Exclusive)

* The lower byte (11H) of Master Volume will be handled as 00H.

* The Master Level parameter (SYSTEM/SOUND) will change.

○Master Fine Tuning

Status	Data byte	Status
F0H	7FH, 7FH, 04H, 03H, 11H, mmH	F7H

Byte	Explanation
F0H	Exclusive status
7FH	ID number (universal realtime message)
7FH	Device ID (Broadcast)
04H	Sub ID#1 (Device Control)
03H	Sub ID#2 (Master Fine Tuning)
11H	Master Fine Tuning LSB
mmH	Master Fine Tuning MSB
F7H	EOX (End Of Exclusive)

mm, ll: 00 00H - 40 00H - 7F 7FH (-100 - 0 - +99.9 [cents])

* The Master Tune parameter (SYSTEM/SOUND) will change.

○Master Coarse Tuning

Status	Data byte	Status
F0H	7FH, 7FH, 04H, 04H, 11H, mmH	F7

Byte	Explanation
F0H	Exclusive status
7FH	ID number (universal realtime message)
7FH	Device ID (Broadcast)
04H	Sub ID#1 (Device Control)
04H	Sub ID#2 (Master Coarse Tuning)
11H	Master Coarse Tuning LSB
mmH	Master Coarse Tuning MSB
F7H	EOX (End Of Exclusive)

11H: ignored (processed as 00H)

mmH: 28H - 40H - 58H (-24 - 0 - +24 [semitones])

* The Master Key Shift parameter (SYSTEM/SOUND) will change.

●Global Parameter Control

* Not received in Patch mode and Piano mode.

○Reverb Parameters

Status	Data byte	Status
F0H	7FH, 7FH, 04H, 05H, 01H, 01H, 01H, 01H, 01H, ppH, vvH	F7H

Byte	Explanation
F0H	Exclusive status
7FH	ID number (universal realtime message)
7FH	Device ID (Broadcast)
04H	Sub ID#1 (Device Control)
05H	Sub ID#2 (Global Parameter Control)
01H	Slot path length
01H	Parameter ID width
01H	Value width
01H	Slot path MSB
01H	Slot path LSB (Effect 0101: Reverb)
ppH	Parameter to be controlled.
vvH	Value for the parameter.
	pp=0 Reverb Type
	vv = 00H Small Room
	vv = 01H Medium Room
	vv = 02H Large Room
	vv = 03H Medium Hall
	vv = 04H Large Hall
	vv = 08H Plate
	pp=1 Reverb Time
	vv = 00H - 7FH 0 - 127
F7H	EOX (End Of Exclusive)

○Chorus Parameters

Status	Data byte	Status
F0H	7FH, 7FH, 04H, 05H, 01H, 01H, 01H, 01H, 02H, ppH, vvH	F7H

Byte	Explanation
F0H	Exclusive status
7FH	ID number (universal realtime message)
7FH	Device ID (Broadcast)
04H	Sub ID#1 (Device Control)
05H	Sub ID#2 (Global Parameter Control)
01H	Slot path length
01H	Parameter ID width
01H	Value width
01H	Slot path MSB
02H	Slot path LSB (Effect 0102: Chorus)
ppH	Parameter to be controlled.
vvH	Value for the parameter.
	pp=0 Chorus Type
	vv=0 Chorus1
	vv=1 Chorus2
	vv=2 Chorus3
	vv=3 Chorus4
	vv=4 FB Chorus
	vv=5 Flanger
	pp=1 Mod Rate
	vv= 00H - 7FH 0 - 127
	pp=2 Mod Depth
	vv = 00H - 7FH 0 - 127
	pp=3 Feedback
	vv = 00H - 7FH 0 - 127
	pp=4 Send To Reverb
	vv = 00H - 7FH 0 - 127
F7H	EOX (End Of Exclusive)

○Channel Pressure

Status	Data byte	Status
F0H	7FH, 7FH, 09H, 01H, 0nH, ppH, rrH	F7H

Byte	Explanation
F0H	Exclusive status
7FH	ID number (universal realtime message)
7FH	Device ID (Broadcast)
09H	Sub ID#1 (Controller Destination Setting)
01H	Sub ID#2 (Channel Pressure)
0nH	MIDI Channel (00 - 0F)
ppH	Controlled parameter
rrH	Controlled range
pp=0	Pitch Control
rr = 28H - 58H -24 - +24	[semitones]
pp=1	Filter Cutoff Control
rr = 00H - 7FH -9600 - +9450	[cents]
pp=2	Amplitude Control
rr = 00H - 7FH 0 - 200%	
pp=3	LFO Pitch Depth
rr = 00H - 7FH 0 - 600	[cents]
pp=4	LFO Filter Depth
rr = 00H - 7FH 0 - 2400	[cents]
pp=5	LFO Amplitude Depth
rr = 00H - 7FH 0 - 100%	
F7H	EOX (End Of Exclusive)

○Controller

Status	Data byte	Status
F0H	7FH, 7FH, 09H, 03H, 0nH, ccH, ppH, rrH	F7H

Byte	Explanation
F0H	Exclusive status
7FH	ID number (universal realtime message)
7FH	Device ID (Broadcast)
09H	Sub ID#1 (Controller Destination Setting)
03H	Sub ID#2 (Control Change)
0nH	MIDI Channel (00 - 0F)
ccH	Controller number (01 - 1F, 40 - 5F)
ppH	Controlled parameter
rrH	Controlled range
pp=0	Pitch Control
rr = 28H - 58H -24 - +24	[semitones]
pp=1	Filter Cutoff Control
rr = 00H - 7FH -9600 - +9450	[cents]
pp=2	Amplitude Control
rr = 00H - 7FH 0 - 200%	
pp=3	LFO Pitch Depth
rr = 00H - 7FH 0 - 600	[cents]
pp=4	LFO Filter Depth
rr = 00H - 7FH 0 - 2400	[cents]
pp=5	LFO Amplitude Depth
rr = 00H - 7FH 0 - 100%	
F7H	EOX (End Of Exclusive)

○Scale/Octave Tuning Adjust

Status	Data byte	Status
F0H	7EH, 7FH, 08H, 08H, ffH, ggH, hhH, ssH... F7	

Byte	Explanation
F0H	Exclusive status
7EH	ID number (Universal Non-realtime Message)
7FH	Device ID (Broadcast)
08H	Sub ID#1 (MIDI Tuning Standard)
08H	Sub ID#2 (scale/octave tuning 1-byte form)
ffH	Channel/Option byte 1
	bits 0 to 1 = channel 15 to 16
	bit 2 to 6 = Undefined
ggH	Channel byte 2
	bits 0 to 6 = channel 8 to 14
hhH	Channel byte 3
	bits 0 to 6 = channel 1 to 7
ssH	12 byte tuning offset of 12 semitones from C to B
00H	= -64 [cents]
40H	= 0 [cents] (equal temperament)
7FH	= +63 [cents]
F7H	EOX (End Of Exclusive)

○Key-based Instrument Controllers

Status	Data byte	Status
F0H	7FH, 7FH, 0AH, 01H, 0nH, kkH, nnH, vvH	F7H

Byte	Explanation
F0H	Exclusive status
7FH	ID number (universal realtime message)
7FH	Device ID (Broadcast)
0AH	Sub ID#1 (Key-Based Instrument Control)
01H	Sub ID#2 (Controller)
0nH	MIDI Channel (00 - 0FH)
kkH	Key Number
nnH	Control Number
vvH	Value
nn=07H	Level
vv = 00H - 7FH	0 - 200% (Relative)
nn=0AH	Pan
vv = 00H - 7FH	Left - Right (Absolute)
nn=5BH	Reverb Send
vv = 00H - 7FH	0 - 127 (Absolute)
nn=5D	Chorus Send
vv = 00H - 7FH	0 - 127 (Absolute)
:	:
F7	EOX (End Of Exclusive)

* This parameter affects drum instruments only.

●Data Transmission

This instrument can use exclusive messages to exchange many varieties of internal settings with other devices.

The model ID of the exclusive messages used by this instrument is 00H 6BH.

○Data Request 1 RQ1

This message requests the other device to transmit data. The address and size indicate the type and amount of data that is requested.

When a Data Request message is received, if the device is in a state in which it is able to transmit data, and if the address and size are appropriate, the requested data is transmitted as a Data Set 1 (DT1) message. If the conditions are not met, nothing is transmitted.

Status	data byte	status
F0H	41H, dev, 00H, 6BH, 11H, aaH, bbH, ccH, ddH, ssH, ttH, uuH, vvH, sum	F7H

Byte	Remarks
F0H	Exclusive status
41H	ID number (Roland)
dev	device ID (dev: 10H - 1FH, 7FH)
00H	model ID #1 (Fantom-X6/X7/X8)
6BH	model ID #2 (Fantom-X6/X7/X8)
11H	command ID (RQ1)
aaH	address MSB
bbH	address
ccH	address
ddH	address LSB
ssH	size MSB
ttH	size
uuH	size
vvH	size LSB
sum	checksum
F7H	EOX (End Of Exclusive)

* The size of data that can be transmitted at one time is fixed for each type of data. And data requests must be made with a fixed starting address and size. Refer to the address and size given in **Parameter Address Map** (P.311).

* For the checksum, refer to P.329.

* Not received when the Receive Exclusive parameter (SYSTEM/MIDI) is OFF.

MIDI Implementation

○Data set 1

DT1

Status	Data byte	Status
F0H	41H, dev, 00H, 6BH, 12H, aaH, bbH, ccH, ddH, eeH, ... ffH, sum	F7H

Byte	Explanation
F0H	Exclusive status
41H	ID number (Roland)
dev	Device ID (dev: 00H - 1FH, 7FH)
00H	Model ID #1 (Fantom-X6/X7/X8)
6BH	Model ID #2 (Fantom-X6/X7/X8)
12H	Command ID (DT1)
aaH	Address MSB: upper byte of the starting address of the data to be sent
bbH	Address: upper middle byte of the starting address of the data to be sent
ccH	Address: lower middle byte of the starting address of the data to be sent
ddH	Address LSB: lower byte of the starting address of the data to be sent.
eeH	Data: the actual data to be sent. Multiple bytes of data are transmitted in order starting from the address.
:	:
ffH	Data
sum	Checksum
F7H	EOX (End Of Exclusive)

- * The amount of data that can be transmitted at one time depends on the type of data, and data will be transmitted from the specified starting address and size. Refer to the address and size given in **Parameter Address Map** (P.311).
- * Data larger than 256 bytes will be divided into packets of 256 bytes or less, and each packet will be sent at an interval of about 20 ms.
- * Regarding the checksum, please refer to P.329.
- * Not received when the Receive Exclusive parameter (SYSTEM/MIDI) is OFF.

Status	Data byte	Status
F0H	41H, dev, 42H, 12H, aaH, bbH, ccH, ddH, ... eeH, sum	F7H

Byte	Explanation
F0H	Exclusive status
41H	ID number (Roland)
dev	Device ID (dev: 10H - 1FH, 7FH)
42H	Model ID (GS)
12H	Command ID (DT1)
aaH	Address MSB: upper byte of the starting address of the transmitted data
bbH	Address: middle byte of the starting address of the transmitted data
ccH	Address LSB: lower byte of the starting address of the transmitted data
ddH	Data: the actual data to be transmitted. Multiple bytes of data are transmitted starting from the address.
:	:
eeH	Data
sum	Checksum
F7H	EOX (End Of Exclusive)

- * The amount of data that can be transmitted at one time depends on the type of data, and data will be transmitted from the specified starting address and size. Refer to the address and size given in **Parameter Address Map** (P.311).
- * Data larger than 256 bytes will be divided into packets of 256 bytes or less, and each packet will be sent at an interval of about 20 ms.
- * Regarding the checksum, please refer to P.329.
- * Not received when the Receive Exclusive parameter (SYSTEM/MIDI) is OFF.

2. Data Transmission

■Channel Voice Messages

●Note off

Status	2nd byte	3rd byte
8nH	kkH	vvH
n = MIDI channel number:	0H - FH (ch.1 - 16)	
kk = note number:	00H - 7FH (0 - 127)	
vv = note off velocity:	00H - 7FH (0 - 127)	

●Note on

Status	2nd byte	3rd byte
9nH	kkH	vvH
n = MIDI channel number:	0H - FH (ch.1 - 16)	
kk = note number:	00H - 7FH (0 - 127)	
vv = note on velocity:	01H - 7FH (1 - 127)	

●Polyphonic Key Pressure

Status	2nd byte	3rd byte
AnH	kkH	vvH
n = MIDI channel number:	0H - FH (ch.1 - 16)	
kk = note number:	00H - 7FH (0 - 127)	
vv = Polyphonic Key Pressure:	00H - 7FH (0 - 127)	

●Control Change

- * By selecting a controller number that corresponds to the setting of parameters of controllers (REALTIME CONTROL knob, and so on), the Fantom-X can transmit any control change message.

○Bank Select (Controller number 0, 32)

Status	2nd byte	3rd byte
BnH	00H	mmH
BnH	20H	llH
n = MIDI channel number:	0H - FH (ch.1 - 16)	
mm, ll = Bank number:	00 00H - 7F 7FH (bank.1 - bank.16384)	

- * These messages are transmitted when Patch, Rhythm Set or Performance is selected. But not transmitted when Transmit Program Change or Transmit Bank Select parameter (SYSTEM/MIDI) is OFF.
- * In Performance mode, these messages are not transmitted when External Bank Select MSB or External PC Number parameter (PERFORMANCE/PART) is OFF.
- * Although with the Fantom-X you can select the Bank Select messages to be transmitted, be sure to refer to the Program Change Map on P.330 for the Bank Select messages transmitted when the Fantom-X is select a Patch, Rhythm Set or Performance.
- * The Bank Select Numbers corresponding to SRX series should be referred to the SRX series owner's manual.

○Modulation (Controller number 1)

Status	2nd byte	3rd byte
BnH	01H	vvH
n = MIDI channel number:	0H - FH (ch.1 - 16)	
vv = Modulation depth:	00H - 7FH (0 - 127)	

○Breath type (Controller number 2)

Status	2nd byte	3rd byte
BnH	02H	vvH
n = MIDI channel number:	0H - FH (ch.1 - 16)	
vv = Control value:	00H - 7FH (0 - 127)	

○Portamento Time (Controller number 5)

Status	2nd byte	3rd byte
BnH	05H	vvH
n = MIDI channel number:	0H - FH (ch.1 - 16)	
vv = Portamento Time:	00H - 7FH (0 - 127)	

○Data Entry (Controller number 6, 38)

Status	2nd byte	3rd byte
BnH	06H	mmH
BnH	26H	llH
n = MIDI channel number:	0H - FH (ch.1 - 16)	
mm, ll = the value of the parameter specified by RPN/NRPN		
mm = MSB, ll = LSB		

○Volume (Controller number 7)

Status	2nd byte	3rd byte
BnH	07H	vvH
n = MIDI channel number:	0H - FH (ch.1 - 16)	
vv = Volume:	00H - 7FH (0 - 127)	

* In Performance mode, these messages are not transmitted when External Level parameter (PERFORMANCE/PART) is OFF.

○Panpot (Controller number 10)

Status	2nd byte	3rd byte
BnH	0AH	vvH
n = MIDI channel number:	0H - FH (ch.1 - 16)	
vv = Panpot:	00H - 40H - 7FH (Left - Center - Right),	

* In Performance mode, these messages are not transmitted when External Pan parameter (PERFORMANCE/PART) is OFF.

○Expression (Controller number 11)

Status	2nd byte	3rd byte
BnH	0BH	vvH
n = MIDI channel number:	0H - FH (ch.1 - 16)	
vv = Expression:	00H - 7FH (0 - 127)	

○Hold 1 (Controller number 64)

Status	2nd byte	3rd byte
BnH	40H	vvH
n = MIDI channel number:	0H - FH (ch.1 - 16)	
vv = Control value:	00H - 7FH (0 - 127) 0-63 = OFF, 64-127 = ON	

* When Continuous Hold Pedal parameter (SYSTEM/PEDAL) is OFF, just only 00H (OFF) and 7FH (ON) can be send as the control value.

○Portamento (Controller number 65)

Status	2nd byte	3rd byte
BnH	41H	vvH
n = MIDI channel number:	0H - FH (ch.1 - 16)	
vv = Control value:	00H - 7FH (0 - 127) 0 - 63 = OFF, 64 - 127 = ON	

○Resonance (Controller number 71)

Status	2nd byte	3rd byte
BnH	47H	vvH
n = MIDI channel number:	0H - FH (ch.1 - 16)	
vv = Resonance value (relative change):	00H - 40H - 7FH (-64 - 0 - +63)	

○Release Time (Controller number 72)

Status	2nd byte	3rd byte
BnH	48H	vvH
n = MIDI channel number:	0H - FH (ch.1 - 16)	
vv = Release Time value (relative change):	00H - 40H - 7FH (-64 - 0 - +63)	

○Attack time (Controller number 73)

Status	2nd byte	3rd byte
BnH	49H	vvH
n = MIDI channel number:	0H - FH (ch.1 - 16)	
vv = Attack time value (relative change):	00H - 40H - 7FH (-64 - 0 - +63)	

○Cutoff (Controller number 74)

Status	2nd byte	3rd byte
BnH	4AH	vvH
n = MIDI channel number:	0H - FH (ch.1 - 16)	
vv = Cutoff value (relative change):	00H - 40H - 7FH (-64 - 0 - +63)	

○General Purpose Controller 5 (Controller number 80)

Status	2nd byte	3rd byte
BnH	50H	vvH
n = MIDI channel number:	0H - FH (ch.1 - 16)	
vv = Control value:	00H - 7FH (0 - 127)	

○General Purpose Controller 6 (Controller number 81)

Status	2nd byte	3rd byte
BnH	51H	vvH
n = MIDI channel number:	0H - FH (ch.1 - 16)	
vv = Control value:	00H - 7FH (0 - 127)	

○General Purpose Controller 7 (Controller number 82)

Status	2nd byte	3rd byte
BnH	52H	vvH
n = MIDI channel number:	0H - FH (ch.1 - 16)	
vv = Control value:	00H - 7FH (0 - 127)	

○General Purpose Controller 8 (Controller number 83)

Status	2nd byte	3rd byte
BnH	53H	vvH
n = MIDI channel number:	0H - FH (ch.1 - 16)	
vv = Control value:	00H - 7FH (0 - 127)	

○Portamento control (Controller number 84)

Status	2nd byte	3rd byte
BnH	54H	kkH
n = MIDI channel number:	0H - FH (ch.1 - 16)	
kk = source note number:	00H - 7FH (0 - 127)	

●Program Change

Status	2nd byte
CnH	ppH
n = MIDI channel number:	0H - FH (ch.1 - 16)
pp = Program number:	00H - 7FH (prog.1 - prog.128)

* These messages are transmitted when Patch, Rhythm Set or Performance is selected. But not transmitted when Transmit Program Change parameter (SYSTEM/MIDI) is OFF.

* In Performance mode, these messages are not transmitted when External PC Num parameter (PERFORMANCE/PART) is OFF.

●Channel Pressure

Status	2nd byte
DnH	vvH
n = MIDI channel number:	0H - FH (ch.1 - 16)
vv = Channel Pressure:	00H - 7FH (0 - 127)

●Pitch Bend Change

Status	2nd byte	3rd byte
EnH	llH	mmH
n = MIDI channel number:	0H - FH (ch.1 - 16)	
mm, ll = Pitch Bend value:	00 00H - 40 00H - 7F 7FH (-8192 - 0 - +8191)	

■Channel Mode Messages

●MONO (Controller number 126)

Status	2nd byte	3rd byte
BnH	7EH	mmH
n = MIDI channel number:	0H - FH (ch.1 - 16)	
mm = mono number:	00H - 10H (0 - 16)	

●POLY (Controller number 127)

Status	2nd byte	3rd byte
BnH	7FH	00H
n = MIDI channel number:	0H - FH (ch.1 - 16)	

■System Realtime Messages

●Active Sensing

Status
FEH

* This message is transmitted at intervals of approximately 250 msec.

* This message is not sent when Transmit Active Sensing parameter (SYSTEM/MIDI) is OFF.

MIDI Implementation

■ System Exclusive Messages

Universal Non-realtime System Exclusive Message^① and Data Set 1 (DT1) are the only System Exclusive messages transmitted by the Fantom-X.

● Universal Non-realtime System Exclusive Message

○ Identity Reply Message (Fantom-X6)

Receiving Identity Request Message, the Fantom-X6 send this message.

Status	Data byte	Status
F0H	7EH, dev, 06H, 02H, 41H, 6BH, 01H, 00H, 01H, 00H, 03H, 00H, 00H	F7H

Byte	Explanation
F0H	Exclusive status
7EH	ID number (Universal Non-realtime Message)
dev	Device ID (dev: 10H - 1FH)
06H	Sub ID#1 (General Information)
02H	Sub ID#2 (Identity Reply)
41H	ID number (Roland)
6BH 01H	Device family code
00H 01H	Device family number code
00H 03H 00H 00H	Software revision level
F7H	EOX (End of Exclusive)

○ Identity Reply Message (Fantom-X7)

Receiving Identity Request Message, the Fantom-X7 send this message.

Status	Data byte	Status
F0H	7EH, dev, 06H, 02H, 41H, 6BH, 01H, 00H, 01H, 01H, 03H, 00H, 00H	F7H

Byte	Explanation
F0H	Exclusive status
7EH	ID number (Universal Non-realtime Message)
dev	Device ID (dev: 10H - 1FH)
06H	Sub ID#1 (General Information)
02H	Sub ID#2 (Identity Reply)
41H	ID number (Roland)
6BH 01H	Device family code
00H 01H	Device family number code
01H 03H 00H 00H	Software revision level
F7H	EOX (End of Exclusive)

○ Identity Reply Message (Fantom-X8)

Receiving Identity Request Message, the Fantom-X8 send this message.

Status	Data byte	Status
F0H	7EH, dev, 06H, 02H, 41H, 6BH, 01H, 00H, 01H, 02H, 03H, 00H, 00H	F7H

Byte	Explanation
F0H	Exclusive status
7EH	ID number (Universal Non-realtime Message)
dev	Device ID (dev: 10H - 1FH)
06H	Sub ID#1 (General Information)
02H	Sub ID#2 (Identity Reply)
41H	ID number (Roland)
6BH 01H	Device family code
00H 01H	Device family number code
02H 03H 00H 00H	Software revision level
F7H	EOX (End of Exclusive)

● Data Transmission

○ Data set 1

Status	Data byte	Status
F0H	41H, dev, 00H, 6BH, 12H, aaH, bbH, ccH, ddH, eeH, ... ffH, sum	F7H

Byte	Explanation
F0H	Exclusive status
41H	ID number (Roland)
dev	Device ID (dev: 00H - 1FH, 7FH)
00H	Model ID #1 (Fantom-X6/X7/X8)
6BH	Model ID #2 (Fantom-X6/X7/X8)
12H	Command ID (DT1)
aaH	Address MSB: upper byte of the starting address of the data to be sent
bbH	Address: upper middle byte of the starting address of the data to be sent
ccH	Address: lower middle byte of the starting address of the data to be sent
ddH	Address LSB: lower byte of the starting address of the data to be sent.
eeH	Data: the actual data to be sent. Multiple bytes of data are transmitted in order starting from the address.
:	:
ffH	Data
sum	Checksum
F7H	EOX (End Of Exclusive)

* The amount of data that can be transmitted at one time depends on the type of data, and data will be transmitted from the specified starting address and size. Refer to the address and size given in **Parameter Address Map** (P.311).

* Data larger than 256 bytes will be divided into packets of 256 bytes or less, and each packet will be sent at an interval of about 20 ms.

3. Data reception (Sequencer Section)

3.1 Messages recorded during recording

■ Channel Voice Messages

● Note Off

Status	2nd byte	3rd byte
8nH	kkH	vvH
9nH	kkH	00H
n=MIDI channel number:	0H - FH (ch.1 - ch.16)	
kk=note number:	00H - 7FH (0 - 127)	
vv=note off velocity:	00H - 7FH (0 - 127)	

* Not received when the Note parameter (Recording Select window) is OFF.

● Note on

Status	2nd byte	3rd byte
9nH	kkH	vvH
n=MIDI channel number:	0H - FH (ch.1 - ch.16)	
kk=note number:	00H - 7FH (0 - 127)	
vv=note on velocity:	01H - 7FH (1 - 127)	

* Not received when the Note parameter (Recording Select window) is OFF.

● Polyphonic Aftertouch

Status	2nd byte	3rd byte
AnH	kkH	vvH
n=MIDI channel number:	0H - FH (ch.1 - ch.16)	
kk=note number:	00H - 7FH (0 - 127)	
vv=Polyphonic Aftertouch:	00H - 7FH (0 - 127)	

* Not received when the Poly Aftertouch parameter (Recording Select window) is OFF.

● Control Change

Status	2nd byte	3rd byte
BnH	kkH	vvH
n=MIDI channel number:	0H - FH (ch.1 - ch.16)	
kk=Control number:	00H - 7FH (0 - 127)	
vv=value:	00H - 7FH (0 - 127)	

* Not received when the Control Change parameter (Recording Select window) is OFF.

● Program Change

Status	2nd byte
CnH	ppH
n=MIDI channel number:	0H - FH (ch.1 - ch.16)
pp=Program number:	00H - 7FH (prog.1 - prog.128)

* Not received when the Program Change parameter (Recording Select window) is OFF.

● Channel Aftertouch

Status	2nd byte
DnH	vvH
n=MIDI channel number:	0H - FH (ch.1 - ch.16)
vv=Channel Aftertouch:	00H - 7FH (0 - 127)

* Not received when the Channel Aftertouch parameter (Recording Select window) is OFF.

● Pitch Bend Change

Status	2nd byte	3rd byte
EnH	llH	mmH
n=MIDI channel number:	0H - FH (ch.1 - ch.16)	
mm, ll=Pitch Bend value:	00 00H - 40 00H - 7F 7FH (-8192 - 0 - +8191)	

* Not received when the Pitch Bend parameter (Recording Select window) is OFF.

■ Channel Mode messages

● All Sound Off (Controller number 120)

Status	2nd byte	3rd byte
BnH	78H	00H
n=MIDI channel number:	0H - FH (ch.1 - ch.16)	

● Reset All Controller (Controller number 121)

Status	2nd byte	3rd byte
BnH	79H	00H
n=MIDI channel number:	0H - FH (ch.1 - ch.16)	

● Omni Off (Controller number 124)

Status	2nd byte	3rd byte
BnH	7CH	00H
n=MIDI channel number:	0H - FH (ch.1 - ch.16)	

* The same processing will be done as when an All Note Off message is received.

● Omni On (Controller number 125)

Status	2nd byte	3rd byte
BnH	7DH	00H
n=MIDI channel number:	0H - FH (ch.1 - ch.16)	

* The same processing will be done as when an All Note Off message is received.

● Mono (Controller number 126)

Status	2nd byte	3rd byte
BnH	7EH	mmH
n=MIDI channel number:	0H - FH (ch.1 - ch.16)	
mm=mono number:	00H - 10H (0 - 16)	

* The same processing will be done as when an All Note Off message is received.

● Poly (Controller number 127)

Status	2nd byte	3rd byte
BnH	7FH	00H
n=MIDI channel number:	0H - FH (ch.1 - ch.16)	

* The same processing will be done as when an All Note Off message is received.

■ System Exclusive Messages

Status	Data byte	Status
F0H	iiH, ddH,, eeH	F7H
F0H:	System Exclusive message status	
ii=ID number:	This is the ID number (manufacturer ID) that specifies the manufacturer whose exclusive message this is. Roland's manufacturer ID is 41H. ID numbers 7EH and 7FH are defined in an expansion of the MIDI standard as Universal Non-real-time messages (7EH) and Universal Realtime Messages (7FH).	
dd,...., ee = data:	00H - 7FH (0 - 127)	
F7H:	EOX (End of System Exclusive)	

- * Not received when the System Exclusive parameter (Recording Select window) is OFF.
- * MIDI Machine Control and MIDI Time code is not recorded. (Refer to "3.3 Messages acknowledged for synchronization")

3.2 Messages not recorded during recording

■ Channel mode messages

● Local On/Off (Controller number 122)

Status	2nd byte	3rd byte
BnH	7AH	vvH
n=MIDI channel number:	0H - FH (ch.1 - ch.16)	
vv=Value:	00H, 7FH (Local Off, Local On)	

● All notes off (Controller number 123)

Status	2nd byte	3rd byte
BnH	7BH	00H
n=MIDI channel number:	0H - FH (ch.1 - ch.16)	

- * When an All Note Off message is received, all notes of the corresponding channel that are on will be sent Note Off's, and the resulting Note Off messages will be recorded.

3.3 Messages acknowledged for synchronization

■ System Common messages

● Tune Request

Status
F6H

● MIDI Time Code Quarter Frame Messages

MIDI Time Code Quarter Frame Messages can be transmitted while the sequencer is running (Playing or Recording) if the Sync Mode parameter (System/Sync/Tempo) is MASTER and MTC Sync Output parameter (System/Sync/Tempo) is ON. The transmitted time counts are summed to MTC Offset Time parameter (System/Sync/Tempo) as the song top is "00:00:00:00."

The sequencer synchronizes with the time counts which are summed to MTC Offset Time parameter (System/Sync/Tempo) as the song top is "00:00:00:00" if the Sync Mode parameter (System/Sync/Tempo) is SLAVE(MTC).

Status	Second
F1H	mmH (= 0nnndddd)
nnn = Message type :	
0 = Frame count LS nibble	
1 = Frame count MS nibble	
2 = Seconds count LS nibble	
3 = Seconds count MS nibble	
4 = Minutes count LS nibble	
5 = Minutes count MS nibble	
6 = Hours count LS nibble	
7 = Hours count MS nibble	
dddd = 4 bit nibble data : h - FH (0 - 15)	
Bit Field is assigned as follows.	

Frame Count	xxxxyyyy	
xxx	Reserved (000)	
yyyyy	Frame No.(0-29)	
Seconds Count	xyyyyyyy	
	xx	Reserved (00)
	yyyyyy	Seconds (0-59)
Minutes Count	xyyyyyyy	
	xx	Reserved (00)
	yyyyyy	Minutes (0-59)
Hours Count	xyzzzzzz	
	x	Reserved (0)
	yy	Time Code type
	0 = 24 Frames / Sec	
	1 = 25 Frames / Sec	
	2 = 30 Frames / Sec (Drop Frame)	
	3 = 30 Frames / Sec (Non Drop Frame)	
	zzzzz	Hours (0-23)

● Song Position Pointer

Status	2nd byte	3rd byte
F2H	mmH	llH
mm, ll=value:	00 00H - 7F 7FH (0 - 16383)	

■ System Realtime Messages

● Timing Clock

Status
F8H

* Received when Sync Mode parameter (System/Sync/Tempo) is set to SLAVE-MIDI.

● Start

Status
FAH

* Received when Sync Mode parameter (System/Sync/Tempo) is set to SLAVE-MIDI or REMOTE.

● Continue

Status
FBH

* Received when Sync Mode parameter (System/Sync/Tempo) is set to SLAVE-MIDI or REMOTE.

● Stop

Status
FCH

* Received when Sync Mode parameter (System/Sync/Tempo) is set to SLAVE-MIDI or REMOTE.

■ System Exclusive Message

● MIDI Machine Control (MMC)

* Received when the MMC Mode parameter (System/Sync/Tempo) is SLAVE.

○ STOP (MCS)

<u>Status</u>	<u>Data byte</u>	<u>Status</u>
F0H	7FH, dev, 06H, 01H	F7H

<u>Byte</u>	<u>Remarks</u>
F0H	Exclusive status
7FH	Universal System Exclusive Realtime Header
7FH	Device ID
06H	MMC command message
01H	STOP (MCS)
F7H	EOX (End of Exclusive)

○ DEFERRED PLAY (MCS)

<u>Status</u>	<u>Data byte</u>	<u>Status</u>
F0H	7FH, dev, 06H, 03H	F7H

<u>Byte</u>	<u>Remarks</u>
F0H	Exclusive status
7FH	Universal System Exclusive Realtime Header
7FH	Device ID
06H	MMC command message
03H	DEFERRED PLAY (MCS)
F7H	EOX (End of Exclusive)

○ LOCATE (MCP)

○ Format2—LOCATE [TARGET]

<u>Status</u>	<u>Data byte</u>	<u>Status</u>
F0H	7FH, dev, 06H, 44H, 06H, 01H, hrH, mnH, scH, frH, ffH	F7H

<u>Byte</u>	<u>Remarks</u>
F0H	Exclusive status
7FH	Universal System Exclusive Realtime Header
7FH	Device ID
06H	MMC command message
44H	LOCATE (MCP)
06H	Byte count
01H	"TARGET" sub-Command
hrH	Standard Time Specification with subframes
mnH	
scH	
frH	
ffH	
F7H	EOX (End of Exclusive)

4. Data transmission (Sequencer Section)

4.1 Messages transmitted during playing

Recorded messages are transmitted during playback.

4.2 Soft Thru setting

Messages (except System Common and System Realtime Messages) that are received are then sent out when Soft Thru parameter (System/Sync/Tempo) is switched to ON.

4.3 Messages that are generated and transmitted

4.3.1 Messages Appearing When Synchronizing with Other Devices

■ System Common Messages

* Sent when Sync Output parameter (System/Sync/Tempo) is set to ON.

● Song Position Pointer

Status	2nd byte	3rd byte
F2H	mmH	llH
mm, ll=value:	00 00H - 7F 7FH (0 - 16383)	

■ System Realtime Messages

* Sent when Sync Output parameter (System/Sync/Tempo) is set to ON.

● Timing Clock

Status
F8H

● Start

Status
FAH

● Continue

Status
FBH

● Stop

Status
FCH

● Quarter Frame Messages

Status	2nd byte
F1H	mmH (= 0nnndddd)

* Sent when Sync Mode parameter (System/Sync/Tempo) is set to MASTER and MTC Sync Output parameter (System/Sync/Tempo) is set to ON. Furthermore, sending a Quarter Frame Message with "00h00m00s00f00" at the beginning of the song adds the MTC Offset Time parameter (System/Sync/Tempo).

■ System Exclusive Message

● MIDI Time code

○ Full Message

Full Messages are used, which encode the complete time into a single message. This message transmitted when the song position moves.

Status	Data Byte	Status
F0H, 7FH xxH, 01H, 01H, hrH, mnH, scH, frH		F7H

F0H, 7FH :	Realtime Universal System Exclusive Header
xxH :	7F (Device ID)
01H :	sub-ID #1 (MIDI Time code)
01H :	sub-ID #2 (Full Message)
hrH :	hours and type: 0 yy zzzzz
yy type:	
	00 = 24 Flame/sec
	01 = 25 Flame/sec
	10 = 30 Flame/sec
	11 = 30 Flame/sec
zzzzz :	Hours (00 - 23)
mnH :	Minutes (00 - 59)
scH :	Seconds (00 - 59)
frH :	Frames (00 - 29)
F7H :	EOX (End of Exclusive)

● MIDI Machine Control (MMC)

* Not received when the MMC Mode parameter (System/Sync/Tempo) is Master.

○ STOP (MCS)

Status	Data byte	Status
F0H	7FH, dev, 06H, 01H	F7H

Byte	Remarks
F0H	Exclusive status
7FH	Universal System Exclusive Realtime Header
7FH	Device ID
06H	MMC command message
01H	STOP (MCS)
F7H	EOX (End of Exclusive)

○ DEFERRED PLAY (MCS)

Status	Data byte	Status
F0H	7FH, dev, 06H, 03H	F7H

Byte	Remarks
F0H	Exclusive status
7FH	Universal System Exclusive Realtime Header
7FH	Device ID
06H	MMC command message
03H	DEFERRED PLAY (MCS)
F7H	EOX (End of Exclusive)

○ LOCATE (MCP)

○ Format2—LOCATE [TARGET]

Status	Data byte	Status
F0H	7FH, dev, 06H, 44H, 06H, 01H, hrH, mnH, scH, frH, ffH	F7H

Byte	Remarks
F0H	Exclusive status
7FH	Universal System Exclusive Realtime Header
7FH	Device ID
06H	MMC command message
44H	LOCATE (MCP)
06H	Byte count
01H	"TARGET" sub-Command
hrH	Standard Time Specification with subframes
mnH	
scH	
frH	
ffH	
F7H	EOX (End of Exclusive)

5. Parameter Address Map

- * Transmission of “#” marked address is divided to some packets. For example, ABH in hexadecimal notation will be divided to 0AH and 0BH, and is sent/received in this order.
- * “<” marked address or parameters are ignored when the Fantom-X6/X7/X8 received them.

1. Fantom-X6/X7/X8 (ModelID = 00H 6BH)

Start Address	Description
01 00 00 00	Setup
02 00 00 00	System
10 00 00 00	Temporary Performance
11 00 00 00	Temporary Patch/Rhythm (Performance Mode Part 1)
11 20 00 00	Temporary Patch/Rhythm (Performance Mode Part 2)
:	:
14 60 00 00	Temporary Patch/Rhythm (Performance Mode Part 16)
1E 00 00 00	Temporary Rhythm Pattern
1E 01 00 00	Temporary Arpeggio (Performance Mode)
1E 02 00 00	Temporary Chord (Performance Mode)
1E 03 00 00	Temporary Rhythm Group (Performance Mode)
1E 11 00 00	Temporary Arpeggio (Patch Mode)
1E 12 00 00	Temporary Chord (Patch Mode)
1E 13 00 00	Temporary Rhythm Group (Patch Mode)
1F 00 00 00	Temporary Patch/Rhythm (Patch Mode Part 1)
1F 20 00 00	Temporary Patch/Rhythm (Patch Mode Part 2)

○System

Offset Address	Description
00 00 00	System Common
00 02 00	System Mastering
00 03 00	System External Input
00 40 00	System Controller

○Temporary Patch/Rhythm

Offset Address	Description
00 00 00	Temporary Patch
10 00 00	Temporary Rhythm

○Performance

Offset Address	Description
00 00 00	Performance Common
00 02 00	Performance Common MFX1
00 04 00	Performance Common Chorus
00 06 00	Performance Common Reverb
00 08 00	Performance Common MFX2
00 0A 00	Performance Common MFX3
00 10 00	Performance MIDI (Channel 1)
00 11 00	Performance MIDI (Channel 2)
:	:
00 1F 00	Performance MIDI (Channel 16)
00 20 00	Performance Part (Part 1)
00 21 00	Performance Part (Part 2)
:	:
00 2F 00	Performance Part (Part 16)
00 50 00	Performance Zone (Channel 1)
00 51 00	Performance Zone (Channel 2)
:	:
00 5F 00	Performance Zone (Channel 16)
00 60 00	Performance Controller

○Patch

Offset Address	Description
00 00 00	Patch Common
00 02 00	Patch Common MFX
00 04 00	Patch Common Chorus
00 06 00	Patch Common Reverb
00 10 00	Patch TMT (Tone Mix Table)
00 20 00	Patch Tone (Tone 1)
00 22 00	Patch Tone (Tone 2)
00 24 00	Patch Tone (Tone 3)
00 26 00	Patch Tone (Tone 4)

○Rhythm

Offset Address	Description
00 00 00	Rhythm Common
00 02 00	Rhythm Common MFX
00 04 00	Rhythm Common Chorus
00 06 00	Rhythm Common Reverb
00 10 00	Rhythm Tone (Key # 21)
00 12 00	Rhythm Tone (Key # 22)
:	:
01 3E 00	Rhythm Tone (Key # 108)

○Arpeggio

Offset Address	Description
00 00 00	Arpeggio Common
00 10 00	Arpeggio Pattern (Note 1)
00 11 00	Arpeggio Pattern (Note 2)
:	:
00 1F 00	Arpeggio Pattern (Note 16)

○Chord

Offset	

Address	Description
00 00 00	Chord Pattern

○Rhythm Group

Offset Address	Description
00 00 00	Rhythm Group

○Setup

Offset Address	Description
00 00	0000 0aaa Sound Mode (0 - 5) PATCH, PERFORM, GM1, GM2, GS, PIANO<*>
00 01	0aaa 0aaa Performance Bank Select MSB (CC# 0) (0 - 127)
00 02	0aaa 0aaa Performance Bank Select LSB (CC# 32) (0 - 127)
00 03	0aaa 0aaa Performance Program Number (PC) (0 - 127)
00 04	0aaa 0aaa Kbd Patch Bank Select MSB (CC# 0) (0 - 127)
00 05	0aaa 0aaa Kbd Patch Bank Select LSB (CC# 32) (0 - 127)
00 06	0aaa 0aaa Kbd Patch Program Number (PC) (0 - 127)
00 07	0aaa 0aaa Pad Patch Bank Select MSB (CC# 0) (0 - 127)
00 08	0aaa 0aaa Pad Patch Bank Select LSB (CC# 32) (0 - 127)
00 09	0aaa 0aaa Pad Patch Program Number (PC) (0 - 127)
00 0A	0000 000a MFX1 Switch (0 - 1) BYPASS, ON
00 0B	0000 000a MFX2 Switch (0 - 1) BYPASS, ON
00 0C	0000 000a MFX3 Switch (0 - 1) BYPASS, ON
00 0D	0000 000a Chorus Switch (0 - 1) OFF, ON
00 0E	0000 000a Reverb Switch (0 - 1) OFF, ON
00 0F	0000 000a Input Effect Switch (0 - 1) OFF, ON
00 10	0000 000a Patch Mode Chorus Source (0 - 1) KBD, PAD
00 11	0000 000a Patch Mode Reverb Source (0 - 1) KBD, PAD
00 12	0000 0aaa Transpose Value (59 - 70) -5 - +6
00 13	0000 0aaa Octave Shift (61 - 67) -3 - +3
00 14	0000 0aaa D Beam Select (0 - 3) OFF, PAD-TRIG, SOLO-SYN, ASGN
00 15	0000 00aa Knob Select (0 - 3) OFF, FLT-ENV, ARP-RHY, ASGN
00 16	0000 000a (reserve) <*>
00 17	0aaa 0aaa Arp/Ptn Grid (0 - 8) 04_, 08_, 08L, 08H, 08t, 16_, 16L, 16H, 16t
00 18	0aaa 0aaa Arp/Ptn Duration (0 - 9) 30, 40, 50, 60, 70, 80, 90, 100, 120, FUL
00 19	0000 000a Arpeggio Switch (0 - 1) OFF, ON
00 1A	0aaa 0aaa Arpeggio Bank (0 - 1) USER, PRESET
00 1B	0aaa 0aaa Arpeggio Style (0 - 127) 1 - 128
00 1C	0aaa 0aaa Arpeggio Motif (0 - 11) UP/L, UP/H, UP/_/, dn/L, dn/H, dn/_/, Ud/L, Ud/H, Ud/_/, rn/L, rn/_/, PHRASE
00 1D	0000 0aaa Arpeggio Octave Range (61 - 67) -3 - +3
00 1E	0000 000a Arpeggio Hold (0 - 1) OFF, ON
00 1F	0aaa 0aaa Arpeggio Accent Rate (0 - 100)
00 20	0aaa 0aaa Arpeggio Velocity (0 - 127) REAL, 1 - 127
00 21	0000 000a Rhythm Pattern Switch (0 - 1) OFF, ON
00 22	0aaa 0aaa Rhythm Pattern Bank (0 - 1) USER, PRESET
# 00 23	0000 0aaa Rhythm Pattern Style (0 - 255) 0000 bbbb 1 - 256
00 25	0000 000a Rhythm Pattern Group Bank (0 - 1) USER, PRESET
00 26	0aaa 0aaa Rhythm Pattern Group Number (0 - 31) 1 - 32
00 27	0aaa 0aaa Rhythm Pattern Accent Rate (0 - 100)
00 28	0aaa 0aaa Rhythm Pattern Velocity (0 - 127) REAL, 1 - 127
00 29	0000 000a Chord Switch (0 - 1) OFF, ON
00 2A	0aaa 0aaa Chord Bank (0 - 1) USER, PRESET
00 2B	00aa 0aaa Chord Form (0 - 63)
00 2C	0000 000a Bender and Modulation Part Select (0 - 1) KBD, PAD
00 2D	0000 000a Beam Part Select (0 - 1) KBD, PAD
00 2E	0000 000a Knob Part Select (0 - 1) KBD, PAD
00 2F	0000 000a (reserve) <*>
00 30	0aaa 0aaa (reserve) <*>
00 31	0000 000a Rolled Chord (0 - 1) OFF, ON
00 32	0000 00aa Rolled Chord Type (0 - 2) UP, DOWN, ALTERNATE
00 33	00aa 0aaa Arpeggio Step (0 - 32) AUTO, 1 - 32
00 00 00 34	Total Size

○System Common

Offset Address	Description
# 00 00	0000 0aaa 0000 bbbb 0000 cccc 0000 dddd Master Tune (24 - 2024) -100.0 - 100.0 [cent]

MIDI Implementation

00 04	00aa aaaa	Master Key Shift	(40 - 88) -24 - +24
00 05	0aaa aaaa	Master Level	(0 - 127)
00 06	0000 000a	Scale Tune Switch	(0 - 1) OFF, ON
00 07	0000 000a	Patch Remain	(0 - 1) OFF, ON
00 08	0000 000a	Mix/Parallel	(0 - 1) MIX, PARALLEL
00 09	000a aaaa	Performance Control Channel	(0 - 16) 1 - 16, OFF
00 0A	0000 aaaa	Kbd Patch Rx/Tx Channel	(0 - 15) 1 - 16
00 0B	0000 aaaa	Pad Patch Rx/Tx Channel	(0 - 15) 1 - 16
00 0C	0aaa aaaa	Patch Scale Tune for C	(0 - 127) -64 - +63
00 0D	0aaa aaaa	Patch Scale Tune for C#	(0 - 127) -64 - +63
00 0E	0aaa aaaa	Patch Scale Tune for D	(0 - 127) -64 - +63
00 0F	0aaa aaaa	Patch Scale Tune for D#	(0 - 127) -64 - +63
00 10	0aaa aaaa	Patch Scale Tune for E	(0 - 127) -64 - +63
00 11	0aaa aaaa	Patch Scale Tune for F	(0 - 127) -64 - +63
00 12	0aaa aaaa	Patch Scale Tune for F#	(0 - 127) -64 - +63
00 13	0aaa aaaa	Patch Scale Tune for G	(0 - 127) -64 - +63
00 14	0aaa aaaa	Patch Scale Tune for G#	(0 - 127) -64 - +63
00 15	0aaa aaaa	Patch Scale Tune for A	(0 - 127) -64 - +63
00 16	0aaa aaaa	Patch Scale Tune for A#	(0 - 127) -64 - +63
00 17	0aaa aaaa	Patch Scale Tune for B	(0 - 127) -64 - +63
00 18	0aaa aaaa	System Control 1 Source	(0 - 97) OFF, CC01 - CC31, CC33 - CC95, BEND, APT
00 19	0aaa aaaa	System Control 2 Source	(0 - 97) OFF, CC01 - CC31, CC33 - CC95, BEND, APT
00 1A	0aaa aaaa	System Control 3 Source	(0 - 97) OFF, CC01 - CC31, CC33 - CC95, BEND, APT
00 1B	0aaa aaaa	System Control 4 Source	(0 - 97) OFF, CC01 - CC31, CC33 - CC95, BEND, APT
00 1C	0000 000a	Receive Program Change	(0 - 1) OFF, ON
00 1D	0000 000a	Receive Bank Select	(0 - 1) OFF, ON
00 00 00 1E		Total Size	

System Mastering

Offset Address	Description	
00 00	0000 000a	Mastering Switch (0 - 1) OFF, ON
00 01	0aaa aaaa	Low band Attack time (0 - 100)
00 02	0aaa aaaa	Low band Release time (0 - 100)
00 03	00aa aaaa	Low band Threshold (0 - 36) -36, -35, -34, -33, -32, -31, -30, -29, -28, -27, -26, -25, -24, -23, -22, -21, -20, -19, -18, -17, -16, -15, -14, -13, -12, -11, -10, -9, -8, -7, -6, -5, -4, -3, -2, -1, 0 [dB]
00 04	0000 aaaa	Low band Ratio (0 - 13) 1:1.0, 1:1.1, 1:1.2, 1:1.4, 1:1.6, 1:1.8, 1:2.0, 1:2.5, 1:3.2, 1:4.0, 1:5.6, 1:8.0,
00 05	000a aaaa	Low band Level (0 - 24) 0, 1, 2, 3, 4, 5, 6, 7, 8, 9, 10, 11, 12, 13, 14, 15, 16, 17, 18, 19, 20, 21, 22, 23, 24 [dB]
00 06	0aaa aaaa	Mid band Attack time (0 - 100)
00 07	0aaa aaaa	Mid band Release time (0 - 100)
00 08	00aa aaaa	Mid band Threshold (0 - 36) -36, -35, -34, -33, -32, -31, -30, -29, -28, -27, -26, -25, -24, -23, -22, -21, -20, -19, -18, -17, -16, -15, -14, -13, -12, -11, -10, -9, -8, -7, -6, -5, -4, -3, -2, -1, 0 [dB]
00 09	0000 aaaa	Mid band Ratio (0 - 13) 1:1.0, 1:1.1, 1:1.2, 1:1.4, 1:1.6, 1:1.8, 1:2.0, 1:2.5, 1:3.2, 1:4.0, 1:5.6, 1:8.0,
00 0A	000a aaaa	Mid band Level (0 - 24) 0, 1, 2, 3, 4, 5, 6, 7, 8, 9, 10, 11, 12, 13, 14, 15, 16, 17, 18, 19, 20, 21, 22, 23, 24 [dB]
00 0B	0aaa aaaa	High band Attack time (0 - 100)
00 0C	0aaa aaaa	High band Release time (0 - 100)
00 0D	00aa aaaa	High band Threshold (0 - 36) -36, -35, -34, -33, -32, -31, -30, -29, -28, -27, -26, -25, -24, -23, -22, -21, -20, -19, -18, -17, -16, -15, -14, -13, -12, -11, -10, -9, -8, -7, -6, -5, -4, -3, -2, -1, 0 [dB]
00 0E	0000 aaaa	High band Ratio (0 - 13) 1:1.0, 1:1.1, 1:1.2, 1:1.4, 1:1.6, 1:1.8, 1:2.0, 1:2.5, 1:3.2, 1:4.0, 1:5.6, 1:8.0,
00 0F	000a aaaa	High band Level (0 - 24) 0, 1, 2, 3, 4, 5, 6, 7, 8, 9, 10, 11, 12, 13, 14, 15, 16, 17, 18, 19, 20, 21, 22, 23, 24 [dB]
00 10	0000 0aaa	Split Freq Low (0 - 6) 200, 250, 315, 400, 500, 630, 800 [Hz]
00 11	0000 0aaa	Split Freq High (0 - 6) 2000, 2500, 3150, 4000, 5000, 6300, 8000 [Hz]
00 00 00 12		Total Size

System External Input

Offset Address	Description	
00 00	0aaa aaaa	External Dry Send Level (0 - 127)
00 01	0aaa aaaa	External Chorus Send Level (0 - 127)
00 02	0aaa aaaa	External Reverb Send Level (0 - 127)
00 03	0000 aaaa	External Output Assign (0 - 1) MPX, DRY (0 - 2)
00 04	0000 00aa	External Output MPX Select MPX1, MPX2, MPX3
00 05	0000 aaaa	Input Effect Type (1 - 6)
# 00 06	0000 aaaa 0000 bbbb 0000 cccc 0000 dddd	Input Effect Parameter 1 (12768 - 52768) -20000 - +20000
# 00 0A	0000 aaaa 0000 bbbb 0000 cccc 0000 dddd	Input Effect Parameter 2 (12768 - 52768) -20000 - +20000
# 00 0E	0000 aaaa 0000 bbbb 0000 cccc 0000 dddd	Input Effect Parameter 3 (12768 - 52768) -20000 - +20000
# 00 12	0000 aaaa 0000 bbbb 0000 cccc 0000 dddd	Input Effect Parameter 4 (12768 - 52768) -20000 - +20000
# 00 16	0000 aaaa 0000 bbbb 0000 cccc 0000 dddd	Input Effect Parameter 5 (12768 - 52768) -20000 - +20000
# 00 1A	0000 aaaa 0000 bbbb 0000 cccc 0000 dddd	Input Effect Parameter 6 (12768 - 52768) -20000 - +20000
# 00 1E	0000 aaaa 0000 bbbb 0000 cccc 0000 dddd	Input Effect Parameter 7 (12768 - 52768) -20000 - +20000
# 00 22	0000 aaaa 0000 bbbb 0000 cccc 0000 dddd	Input Effect Parameter 8 (12768 - 52768) -20000 - +20000
# 00 26	0000 aaaa 0000 bbbb 0000 cccc 0000 dddd	Input Effect Parameter 9 (12768 - 52768) -20000 - +20000
# 00 2A	0000 aaaa 0000 bbbb 0000 cccc 0000 dddd	Input Effect Parameter 10 (12768 - 52768) -20000 - +20000
# 00 2E	0000 aaaa 0000 bbbb 0000 cccc 0000 dddd	Input Effect Parameter 11 (12768 - 52768) -20000 - +20000
# 00 32	0000 aaaa 0000 bbbb 0000 cccc 0000 dddd	Input Effect Parameter 12 (12768 - 52768) -20000 - +20000
# 00 36	0000 aaaa 0000 bbbb 0000 cccc 0000 dddd	Input Effect Parameter 13 (12768 - 52768) -20000 - +20000
# 00 3A	0000 aaaa 0000 bbbb 0000 cccc 0000 dddd	Input Effect Parameter 14 (12768 - 52768) -20000 - +20000
# 00 3E	0000 aaaa 0000 bbbb 0000 cccc 0000 dddd	Input Effect Parameter 15 (12768 - 52768) -20000 - +20000
# 00 42	0000 aaaa 0000 bbbb 0000 cccc 0000 dddd	Input Effect Parameter 16 (12768 - 52768) -20000 - +20000
# 00 46	0000 aaaa 0000 bbbb 0000 cccc 0000 dddd	Input Effect Parameter 17 (12768 - 52768) -20000 - +20000
# 00 4A	0000 aaaa 0000 bbbb 0000 cccc 0000 dddd	Input Effect Parameter 18 (12768 - 52768) -20000 - +20000
# 00 4E	0000 aaaa 0000 bbbb 0000 cccc 0000 dddd	Input Effect Parameter 19 (12768 - 52768) -20000 - +20000
# 00 52	0000 aaaa 0000 bbbb 0000 cccc 0000 dddd	Input Effect Parameter 20 (12768 - 52768) -20000 - +20000
00 00 00 56		Total Size

System Controller

Offset Address	Description	
00 00	0000 000a	Transmit Program Change (0 - 1)
00 01	0000 000a	Transmit Bank Select OFF, ON (0 - 1)
00 02	0aaa aaaa	Keyboard Velocity OFF, ON (0 - 127)
00 03	0000 00aa	Keyboard Sens REAL, 1 - 127 (0 - 2)
00 04	0aaa aaaa	Aftertouch Sens LIGHT, MEDIUM, HEAVY (0 - 100)
00 05	0000 0aaa	Hold Pedal Polarity (0 - 1) STANDARD, REVERSE

MIDI Implementation

00 06	0000 000a	Continuous Hold Pedal	(0 - 1) OFF, ON
00 07	0aaa aaaa	Pedal Assign	(0 - 111) CC01 - CC31, CC33 - CC95, BEND-UP, BEND-DOWN, APT, OCT-UP, OCT-DOWN, START/STOP, PUNCH-I/O, TAP-TEMPO, PROG-UP, PROG-DOWN, FAV-UP, FAV-DOWN, ARP-RHY-SW, RHY-START/STOP, CHD-SW, APAV-UP, APAV-DOWN, SEQ-LOOP
00 08	0000 0aaa	Pedal Polarity	(0 - 1) STANDARD, REVERSE
00 09	0000 aaaa	Beam Sens	(1 - 10)
00 0A	0aaa aaaa	Beam Assign	(0 - 104) CC01 - CC31, CC33 - CC95, BEND-UP, BEND-DOWN, START/STOP, TAP-TEMPO, ARP-GRID, ARP-DUR, ARP-MOTIF, ARP-OCT-UP, ARP-OCT-DW, ARP-STEP, APT
00 0B	0aaa aaaa	Beam Range Lower	(0 - 127)
00 0C	0aaa aaaa	Beam Range Upper	(0 - 127)
00 0D	0000 aaaa	Beam Trigger Pad	(0 - 15)
00 0E	0aaa aaaa	Beam Trigger Velo	1 - 16
00 0F	0aaa aaaa	Beam Trigger Mode	(1 - 127) (0 - 1) MOMENTARY, LATCH
00 10	0aaa aaaa	Knob 1 Assign	(0 - 103) CC01 - CC31, CC33 - CC95, BEND, APT, ARP-STYLE, ARP-GRID, ARP-DUR, ARP-MOTIF, CHORD-FORM, MASTER-LEVEL, ARP-STEP, DIGI-IN
00 11	0aaa aaaa	Knob 2 Assign	(0 - 103) CC01 - CC31, CC33 - CC95, BEND, APT, ARP-STYLE, ARP-GRID, ARP-DUR, ARP-MOTIF, CHORD-FORM, MASTER-LEVEL, ARP-STEP, DIGI-IN
00 12	0aaa aaaa	Knob 3 Assign	(0 - 103) CC01 - CC31, CC33 - CC95, BEND, APT, ARP-STYLE, ARP-GRID, ARP-DUR, ARP-MOTIF, CHORD-FORM, MASTER-LEVEL, ARP-STEP, DIGI-IN
00 13	0aaa aaaa	Knob 4 Assign	(0 - 103) CC01 - CC31, CC33 - CC95, BEND, APT, ARP-STYLE, ARP-GRID, ARP-DUR, ARP-MOTIF, CHORD-FORM, MASTER-LEVEL, ARP-STEP, DIGI-IN
00 14	0aaa aaaa	Switch 1 Assign	(0 - 13) TRNS-DW, TRNS-UP, TAP-TEMPO, MONO/POLY, PORTAMENTO, HOLD1, MPX1-SW, MPX2-SW, MPX3-SW, CHO-SW, REV-SW, MAS-SW, SEQ-LOOP, RHY-START/STOP
00 15	0aaa aaaa	Switch 2 Assign	(0 - 13) TRNS-DW, TRNS-UP, TAP-TEMPO, MONO/POLY, PORTAMENTO, HOLD1, MPX1-SW, MPX2-SW, MPX3-SW, CHO-SW, REV-SW, MAS-SW, SEQ-LOOP, RHY-START/STOP
00 16	0aaa aaaa	Pad Velocity	(0 - 127) REAL, 1 - 127
00 17	0000 00aa	Pad Sens	(0 - 2) LIGHT, MEDIUM, HEAVY
00 18	0aaa aaaa	Pad Aftertouch Sens	(0 - 100)
00 19	0000 aaaa	Pad Roll Resolution	(0 - 7)
00 1A	0aaa aaaa	(reserve) <*>	
00 1B	0aaa aaaa	(reserve) <*>	
00 1C	0aaa aaaa	(reserve) <*>	
00 1D	0aaa aaaa	Pad 1 Note Number	(0 - 127) C-1 - G9
00 1E	0aaa aaaa	Pad 1 Velocity	(0 - 127) REAL, 1 - 127
00 1F	0aaa aaaa	(reserve) <*>	
00 20	0aaa aaaa	Pad 2 Note Number	(0 - 127) C-1 - G9
00 21	0aaa aaaa	Pad 2 Velocity	(0 - 127) REAL, 1 - 127
00 22	0aaa aaaa	(reserve) <*>	
00 23	0aaa aaaa	Pad 3 Note Number	(0 - 127) C-1 - G9
00 24	0aaa aaaa	Pad 3 Velocity	(0 - 127) REAL, 1 - 127
00 25	0aaa aaaa	(reserve) <*>	
00 26	0aaa aaaa	Pad 4 Note Number	(0 - 127) C-1 - G9
00 27	0aaa aaaa	Pad 4 Velocity	(0 - 127) REAL, 1 - 127
00 28	0aaa aaaa	(reserve) <*>	
00 29	0aaa aaaa	Pad 5 Note Number	(0 - 127) C-1 - G9
00 2A	0aaa aaaa	Pad 5 Velocity	(0 - 127) REAL, 1 - 127
00 2B	0aaa aaaa	(reserve) <*>	
00 2C	0aaa aaaa	Pad 6 Note Number	(0 - 127) C-1 - G9
00 2D	0aaa aaaa	Pad 6 Velocity	(0 - 127) REAL, 1 - 127
00 2E	0aaa aaaa	(reserve) <*>	
00 2F	0aaa aaaa	Pad 7 Note Number	(0 - 127) C-1 - G9
00 30	0aaa aaaa	Pad 7 Velocity	(0 - 127) REAL, 1 - 127
00 31	0aaa aaaa	(reserve) <*>	
00 32	0aaa aaaa	Pad 8 Note Number	(0 - 127) C-1 - G9
00 33	0aaa aaaa	Pad 8 Velocity	(0 - 127) REAL, 1 - 127
00 34	0aaa aaaa	(reserve) <*>	
00 35	0aaa aaaa	Pad 9 Note Number	(0 - 127) C-1 - G9
00 36	0aaa aaaa	Pad 9 Velocity	(0 - 127) REAL, 1 - 127
00 37	0aaa aaaa	(reserve) <*>	
00 38	0aaa aaaa	Pad 10 Note Number	(0 - 127) C-1 - G9
00 39	0aaa aaaa	Pad 10 Velocity	(0 - 127) REAL, 1 - 127
00 3A	0aaa aaaa	(reserve) <*>	
00 3B	0aaa aaaa	Pad 11 Note Number	(0 - 127) C-1 - G9
00 3C	0aaa aaaa	Pad 11 Velocity	(0 - 127) REAL, 1 - 127
00 3D	0aaa aaaa	(reserve) <*>	
00 3E	0aaa aaaa	Pad 12 Note Number	(0 - 127) C-1 - G9
00 3F	0aaa aaaa	Pad 12 Velocity	(0 - 127) REAL, 1 - 127
00 40	0aaa aaaa	(reserve) <*>	
00 41	0aaa aaaa	Pad 13 Note Number	(0 - 127) C-1 - G9

00 42	0aaa aaaa	Pad 13 Velocity	(0 - 127) REAL, 1 - 127
00 43	0aaa aaaa	(reserve) <*>	
00 44	0aaa aaaa	Pad 14 Note Number	(0 - 127) C-1 - G9
00 45	0aaa aaaa	Pad 14 Velocity	(0 - 127) REAL, 1 - 127
00 46	0aaa aaaa	(reserve) <*>	
00 47	0aaa aaaa	Pad 15 Note Number	(0 - 127) C-1 - G9
00 48	0aaa aaaa	Pad 15 Velocity	(0 - 127) REAL, 1 - 127
00 49	0aaa aaaa	(reserve) <*>	
00 4A	0aaa aaaa	Pad 16 Note Number	(0 - 127) C-1 - G9
00 4B	0aaa aaaa	Pad 16 Velocity	(0 - 127) REAL, 1 - 127
00 00 00 4C	Total Size		

Performance Common

Offset Address	Description	
00 00	0aaa aaaa	Performance Name 1 (32 - 127) [ASCII]
00 01	0aaa aaaa	Performance Name 2 (32 - 127) [ASCII]
00 02	0aaa aaaa	Performance Name 3 (32 - 127) [ASCII]
00 03	0aaa aaaa	Performance Name 4 (32 - 127) [ASCII]
00 04	0aaa aaaa	Performance Name 5 (32 - 127) [ASCII]
00 05	0aaa aaaa	Performance Name 6 (32 - 127) [ASCII]
00 06	0aaa aaaa	Performance Name 7 (32 - 127) [ASCII]
00 07	0aaa aaaa	Performance Name 8 (32 - 127) [ASCII]
00 08	0aaa aaaa	Performance Name 9 (32 - 127) [ASCII]
00 09	0aaa aaaa	Performance Name 10 (32 - 127) [ASCII]
00 0A	0aaa aaaa	Performance Name 11 (32 - 127) [ASCII]
00 0B	0aaa aaaa	Performance Name 12 (32 - 127) [ASCII]
00 0C	00aa aaaa	Solo Part Select (0 - 16) OFF, 1 - 16
00 0D	000a aaaa	MPX1 Control Channel (0 - 16) 1 - 16, OFF
00 0E	0000 000a	(reserve) <*> (1 - 0)
00 0F	0000 000a	(reserve) <*> (1 - 0)
00 10	0aaa aaaa	Voice Reserve 1 (0 - 64)
00 11	0aaa aaaa	Voice Reserve 2 (0 - 64)
00 12	0aaa aaaa	Voice Reserve 3 (0 - 64)
00 13	0aaa aaaa	Voice Reserve 4 (0 - 64)
00 14	0aaa aaaa	Voice Reserve 5 (0 - 64)
00 15	0aaa aaaa	Voice Reserve 6 (0 - 64)
00 16	0aaa aaaa	Voice Reserve 7 (0 - 64)
00 17	0aaa aaaa	Voice Reserve 8 (0 - 64)
00 18	0aaa aaaa	Voice Reserve 9 (0 - 64)
00 19	0aaa aaaa	Voice Reserve 10 (0 - 64)
00 1A	0aaa aaaa	Voice Reserve 11 (0 - 64)
00 1B	0aaa aaaa	Voice Reserve 12 (0 - 64)
00 1C	0aaa aaaa	Voice Reserve 13 (0 - 64)
00 1D	0aaa aaaa	Voice Reserve 14 (0 - 64)
00 1E	0aaa aaaa	Voice Reserve 15 (0 - 64)
00 1F	0aaa aaaa	Voice Reserve 16 (0 - 64)
00 20	0aaa aaaa	(reserve) <*> (0 - 64)
00 21	0aaa aaaa	(reserve) <*> (0 - 64)
00 22	0aaa aaaa	(reserve) <*> (0 - 64)
00 23	0aaa aaaa	(reserve) <*> (0 - 64)
00 24	0aaa aaaa	(reserve) <*> (0 - 64)
00 25	0aaa aaaa	(reserve) <*> (0 - 64)
00 26	0aaa aaaa	(reserve) <*> (0 - 64)
00 27	0aaa aaaa	(reserve) <*> (0 - 64)
00 28	0aaa aaaa	(reserve) <*> (0 - 64)
00 29	0aaa aaaa	(reserve) <*> (0 - 64)
00 2A	0aaa aaaa	(reserve) <*> (0 - 64)
00 2B	0aaa aaaa	(reserve) <*> (0 - 64)
00 2C	0aaa aaaa	(reserve) <*> (0 - 64)
00 2D	0aaa aaaa	(reserve) <*> (0 - 64)
00 2E	0aaa aaaa	(reserve) <*> (0 - 64)
00 2F	0aaa aaaa	(reserve) <*> (0 - 64)
00 30	00aa aaaa	MPX1 Source (0 - 16) PERFORM, 1 - 16
00 31	00aa aaaa	MPX2 Source (0 - 16) PERFORM, 1 - 16
00 32	00aa aaaa	MPX3 Source (0 - 16) PERFORM, 1 - 16
00 33	00aa aaaa	Chorus Source (0 - 16) PERFORM, 1 - 16
00 34	00aa aaaa	Reverb Source (0 - 16) PERFORM, 1 - 16
00 35	00aa aaaa	MPX2 Control Channel (0 - 16)

MIDI Implementation

00 36	00aa aaaa	MF3 Control Channel	1 - 16, OFF (0 - 16)
00 37	0000 aaaa	MF3 Structure	1 - 16, OFF (0 - 15) 1 - 16
00 00 00 38	Total Size		

Performance Common MF3

Offset Address	Description	
00 00	0aaa aaaa	MF3 Type (0 - 78)
00 01	0aaa aaaa	MF3 Dry Send Level (0 - 127)
00 02	0aaa aaaa	MF3 Chorus Send Level (0 - 127)
00 03	0aaa aaaa	MF3 Reverb Send Level (0 - 127)
00 04	0000 00aa	MF3 Output Assign (0 - 3) A, B, ---, ---
00 05	0aaa aaaa	MF3 Control 1 Source (0 - 101) OFF, CC01 - CC31, CC33 - CC95, BEND, APT, SYS1 - SYS4
00 06	0aaa aaaa	MF3 Control 1 Sens (-63 - +63) (0 - 101)
00 07	0aaa aaaa	MF3 Control 2 Source (0 - 101) OFF, CC01 - CC31, CC33 - CC95, BEND, APT, SYS1 - SYS4
00 08	0aaa aaaa	MF3 Control 2 Sens (-63 - +63) (0 - 101)
00 09	0aaa aaaa	MF3 Control 3 Source (0 - 101) OFF, CC01 - CC31, CC33 - CC95, BEND, APT, SYS1 - SYS4
00 0A	0aaa aaaa	MF3 Control 3 Sens (-63 - +63) (0 - 101)
00 0B	0aaa aaaa	MF3 Control 4 Source (0 - 101) OFF, CC01 - CC31, CC33 - CC95, BEND, APT, SYS1 - SYS4
00 0C	0aaa aaaa	MF3 Control 4 Sens (-63 - +63) (0 - 101)
00 0D	000a aaaa	MF3 Control Assign 1 (0 - 16) OFF, 1 - 16
00 0E	000a aaaa	MF3 Control Assign 2 (0 - 16) OFF, 1 - 16
00 0F	000a aaaa	MF3 Control Assign 3 (0 - 16) OFF, 1 - 16
00 10	000a aaaa	MF3 Control Assign 4 (0 - 16) OFF, 1 - 16
# 00 11	0000 aaaa 0000 bbbb 0000 cccc 0000 dddd	MF3 Parameter 1 (12768 - 52768) -20000 - +20000
# 00 15	0000 aaaa 0000 bbbb 0000 cccc 0000 dddd	MF3 Parameter 2 (12768 - 52768) -20000 - +20000
# 00 19	0000 aaaa 0000 bbbb 0000 cccc 0000 dddd	MF3 Parameter 3 (12768 - 52768) -20000 - +20000
# 00 1D	0000 aaaa 0000 bbbb 0000 cccc 0000 dddd	MF3 Parameter 4 (12768 - 52768) -20000 - +20000
# 00 21	0000 aaaa 0000 bbbb 0000 cccc 0000 dddd	MF3 Parameter 5 (12768 - 52768) -20000 - +20000
# 00 25	0000 aaaa 0000 bbbb 0000 cccc 0000 dddd	MF3 Parameter 6 (12768 - 52768) -20000 - +20000
# 00 29	0000 aaaa 0000 bbbb 0000 cccc 0000 dddd	MF3 Parameter 7 (12768 - 52768) -20000 - +20000
# 00 2D	0000 aaaa 0000 bbbb 0000 cccc 0000 dddd	MF3 Parameter 8 (12768 - 52768) -20000 - +20000
# 00 31	0000 aaaa 0000 bbbb 0000 cccc 0000 dddd	MF3 Parameter 9 (12768 - 52768) -20000 - +20000
# 00 35	0000 aaaa 0000 bbbb 0000 cccc 0000 dddd	MF3 Parameter 10 (12768 - 52768) -20000 - +20000
# 00 39	0000 aaaa 0000 bbbb 0000 cccc 0000 dddd	MF3 Parameter 11 (12768 - 52768) -20000 - +20000
# 00 3D	0000 aaaa 0000 bbbb 0000 cccc 0000 dddd	MF3 Parameter 12 (12768 - 52768) -20000 - +20000
# 00 41	0000 aaaa 0000 bbbb 0000 cccc 0000 dddd	MF3 Parameter 13 (12768 - 52768) -20000 - +20000
# 00 45	0000 aaaa 0000 bbbb 0000 cccc 0000 dddd	MF3 Parameter 14 (12768 - 52768) -20000 - +20000
# 00 49	0000 aaaa 0000 bbbb 0000 cccc 0000 dddd	MF3 Parameter 15 (12768 - 52768) -20000 - +20000
# 00 4D	0000 aaaa 0000 bbbb 0000 cccc 0000 dddd	MF3 Parameter 16 (12768 - 52768) -20000 - +20000
# 00 51	0000 aaaa 0000 bbbb 0000 cccc 0000 dddd	MF3 Parameter 17 (12768 - 52768) -20000 - +20000
# 00 55	0000 aaaa	
00 00 01 11	Total Size	

# 00 59	0000 bbbb 0000 cccc 0000 dddd	MF3 Parameter 18 (12768 - 52768) -20000 - +20000
# 00 5D	0000 aaaa 0000 bbbb 0000 cccc 0000 dddd	MF3 Parameter 19 (12768 - 52768) -20000 - +20000
# 00 61	0000 aaaa 0000 bbbb 0000 cccc 0000 dddd	MF3 Parameter 20 (12768 - 52768) -20000 - +20000
# 00 65	0000 aaaa 0000 bbbb 0000 cccc 0000 dddd	MF3 Parameter 21 (12768 - 52768) -20000 - +20000
# 00 69	0000 aaaa 0000 bbbb 0000 cccc 0000 dddd	MF3 Parameter 22 (12768 - 52768) -20000 - +20000
# 00 6D	0000 aaaa 0000 bbbb 0000 cccc 0000 dddd	MF3 Parameter 23 (12768 - 52768) -20000 - +20000
# 00 71	0000 aaaa 0000 bbbb 0000 cccc 0000 dddd	MF3 Parameter 24 (12768 - 52768) -20000 - +20000
# 00 75	0000 aaaa 0000 bbbb 0000 cccc 0000 dddd	MF3 Parameter 25 (12768 - 52768) -20000 - +20000
# 00 79	0000 aaaa 0000 bbbb 0000 cccc 0000 dddd	MF3 Parameter 26 (12768 - 52768) -20000 - +20000
# 00 7D	0000 aaaa 0000 bbbb 0000 cccc 0000 dddd	MF3 Parameter 27 (12768 - 52768) -20000 - +20000
# 01 01	0000 aaaa 0000 bbbb 0000 cccc 0000 dddd	MF3 Parameter 28 (12768 - 52768) -20000 - +20000
# 01 05	0000 aaaa 0000 bbbb 0000 cccc 0000 dddd	MF3 Parameter 29 (12768 - 52768) -20000 - +20000
# 01 09	0000 aaaa 0000 bbbb 0000 cccc 0000 dddd	MF3 Parameter 30 (12768 - 52768) -20000 - +20000
# 01 0D	0000 aaaa 0000 bbbb 0000 cccc 0000 dddd	MF3 Parameter 31 (12768 - 52768) -20000 - +20000
# 01 11	0000 aaaa 0000 bbbb 0000 cccc 0000 dddd	MF3 Parameter 32 (12768 - 52768) -20000 - +20000
00 00 01 11	Total Size	

Performance Common Chorus

Offset Address	Description	
00 00	0000 aaaa	Chorus Type (0 - 3)
00 01	0aaa aaaa	Chorus Level (0 - 127)
00 02	0000 00aa	Chorus Output Assign (0 - 3) A, B, ---, ---
00 03	0000 00aa	Chorus Output Select (0 - 2) MAIN, REV, MAIN+REV
# 00 04	0000 aaaa 0000 bbbb 0000 cccc 0000 dddd	Chorus Parameter 1 (12768 - 52768) -20000 - +20000
# 00 08	0000 aaaa 0000 bbbb 0000 cccc 0000 dddd	Chorus Parameter 2 (12768 - 52768) -20000 - +20000
# 00 0C	0000 aaaa 0000 bbbb 0000 cccc 0000 dddd	Chorus Parameter 3 (12768 - 52768) -20000 - +20000
# 00 10	0000 aaaa 0000 bbbb 0000 cccc 0000 dddd	Chorus Parameter 4 (12768 - 52768) -20000 - +20000
# 00 14	0000 aaaa 0000 bbbb 0000 cccc 0000 dddd	Chorus Parameter 5 (12768 - 52768) -20000 - +20000
# 00 18	0000 aaaa 0000 bbbb 0000 cccc 0000 dddd	Chorus Parameter 6 (12768 - 52768) -20000 - +20000
# 00 1C	0000 aaaa 0000 bbbb 0000 cccc 0000 dddd	Chorus Parameter 7 (12768 - 52768) -20000 - +20000
# 00 20	0000 aaaa 0000 bbbb 0000 cccc 0000 dddd	Chorus Parameter 8 (12768 - 52768) -20000 - +20000
# 00 24	0000 aaaa 0000 bbbb 0000 cccc 0000 dddd	Chorus Parameter 9 (12768 - 52768) -20000 - +20000
# 00 28	0000 aaaa 0000 bbbb	

MIDI Implementation

#	00 2C	0000 cccc 0000 dddd	Chorus Parameter 10	(12768 - 52768) -20000 - +20000
#	00 30	0000 aaaa 0000 bbbb 0000 cccc 0000 dddd	Chorus Parameter 11	(12768 - 52768) -20000 - +20000
#	00 34	0000 aaaa 0000 bbbb 0000 cccc 0000 dddd	Chorus Parameter 12	(12768 - 52768) -20000 - +20000
#	00 38	0000 aaaa 0000 bbbb 0000 cccc 0000 dddd	Chorus Parameter 13	(12768 - 52768) -20000 - +20000
#	00 3C	0000 aaaa 0000 bbbb 0000 cccc 0000 dddd	Chorus Parameter 14	(12768 - 52768) -20000 - +20000
#	00 40	0000 aaaa 0000 bbbb 0000 cccc 0000 dddd	Chorus Parameter 15	(12768 - 52768) -20000 - +20000
#	00 44	0000 aaaa 0000 bbbb 0000 cccc 0000 dddd	Chorus Parameter 16	(12768 - 52768) -20000 - +20000
#	00 48	0000 aaaa 0000 bbbb 0000 cccc 0000 dddd	Chorus Parameter 17	(12768 - 52768) -20000 - +20000
#	00 4C	0000 aaaa 0000 bbbb 0000 cccc 0000 dddd	Chorus Parameter 18	(12768 - 52768) -20000 - +20000
#	00 50	0000 aaaa 0000 bbbb 0000 cccc 0000 dddd	Chorus Parameter 19	(12768 - 52768) -20000 - +20000
#	00 54	0000 aaaa 0000 bbbb 0000 cccc 0000 dddd	Chorus Parameter 20	(12768 - 52768) -20000 - +20000
	00 00 00 54	Total Size		

Performance Common Reverb

Offset Address	Description	
00 00	0000 aaaa	Reverb Type (0 - 5)
00 01	0aaa aaaa	Reverb Level (0 - 127)
00 02	0000 00aa	Reverb Output Assign (0 - 3) A, B, ---, ---
# 00 03	0000 aaaa 0000 bbbb 0000 cccc 0000 dddd	Reverb Parameter 1 (12768 - 52768) -20000 - +20000
# 00 07	0000 aaaa 0000 bbbb 0000 cccc 0000 dddd	Reverb Parameter 2 (12768 - 52768) -20000 - +20000
# 00 0B	0000 aaaa 0000 bbbb 0000 cccc 0000 dddd	Reverb Parameter 3 (12768 - 52768) -20000 - +20000
# 00 0F	0000 aaaa 0000 bbbb 0000 cccc 0000 dddd	Reverb Parameter 4 (12768 - 52768) -20000 - +20000
# 00 13	0000 aaaa 0000 bbbb 0000 cccc 0000 dddd	Reverb Parameter 5 (12768 - 52768) -20000 - +20000
# 00 17	0000 aaaa 0000 bbbb 0000 cccc 0000 dddd	Reverb Parameter 6 (12768 - 52768) -20000 - +20000
# 00 1B	0000 aaaa 0000 bbbb 0000 cccc 0000 dddd	Reverb Parameter 7 (12768 - 52768) -20000 - +20000
# 00 1F	0000 aaaa 0000 bbbb 0000 cccc 0000 dddd	Reverb Parameter 8 (12768 - 52768) -20000 - +20000
# 00 23	0000 aaaa 0000 bbbb 0000 cccc 0000 dddd	Reverb Parameter 9 (12768 - 52768) -20000 - +20000
# 00 27	0000 aaaa 0000 bbbb 0000 cccc 0000 dddd	Reverb Parameter 10 (12768 - 52768) -20000 - +20000
# 00 2B	0000 aaaa 0000 bbbb 0000 cccc 0000 dddd	Reverb Parameter 11 (12768 - 52768) -20000 - +20000
# 00 2F	0000 aaaa 0000 bbbb 0000 cccc 0000 dddd	Reverb Parameter 12 (12768 - 52768) -20000 - +20000
# 00 33	0000 aaaa 0000 bbbb 0000 cccc 0000 dddd	Reverb Parameter 13 (12768 - 52768) -20000 - +20000
# 00 37	0000 aaaa 0000 bbbb 0000 cccc 0000 dddd	Reverb Parameter 14 (12768 - 52768) -20000 - +20000

#	00 3B	0000 aaaa 0000 bbbb 0000 cccc 0000 dddd	Reverb Parameter 15	(12768 - 52768) -20000 - +20000
#	00 3F	0000 aaaa 0000 bbbb 0000 cccc 0000 dddd	Reverb Parameter 16	(12768 - 52768) -20000 - +20000
#	00 43	0000 aaaa 0000 bbbb 0000 cccc 0000 dddd	Reverb Parameter 17	(12768 - 52768) -20000 - +20000
#	00 47	0000 aaaa 0000 bbbb 0000 cccc 0000 dddd	Reverb Parameter 18	(12768 - 52768) -20000 - +20000
#	00 4B	0000 aaaa 0000 bbbb 0000 cccc 0000 dddd	Reverb Parameter 19	(12768 - 52768) -20000 - +20000
#	00 4F	0000 aaaa 0000 bbbb 0000 cccc 0000 dddd	Reverb Parameter 20	(12768 - 52768) -20000 - +20000
	00 00 00 53	Total Size		

Performance MIDI

Offset Address	Description	
00 00	0000 000a	Receive Program Change (0 - 1) OFF, ON
00 01	0000 000a	Receive Bank Select (0 - 1) OFF, ON
00 02	0000 000a	Receive Bender (0 - 1) OFF, ON
00 03	0000 000a	Receive Polyphonic Key Pressure (0 - 1) OFF, ON
00 04	0000 000a	Receive Channel Pressure (0 - 1) OFF, ON
00 05	0000 000a	Receive Modulation (0 - 1) OFF, ON
00 06	0000 000a	Receive Volume (0 - 1) OFF, ON
00 07	0000 000a	Receive Pan (0 - 1) OFF, ON
00 08	0000 000a	Receive Expression (0 - 1) OFF, ON
00 09	0000 000a	Receive Hold-1 (0 - 1) OFF, ON
00 0A	0000 000a	Phase Lock (0 - 1) OFF, ON
00 0B	0000 0aaa	Velocity Curve Type (0 - 4) OFF, 1 - 4
	00 00 00 0C	Total Size

Performance Part

Offset Address	Description	
00 00	0000 aaaa	Receive Channel (0 - 15) 1 - 16
00 01	0000 000a	Receive Switch (0 - 1) OFF, ON
00 02	0000 0000	(reserve) <*> (1 - 0)
00 03	0000 0000	(reserve) <*> (1 - 0)
00 04	0aaa aaaa	Patch Bank Select MSB (CC# 0) (0 - 127)
00 05	0aaa aaaa	Patch Bank Select LSB (CC# 32) (0 - 127)
00 06	0aaa aaaa	Patch Program Number (PC) (0 - 127)
00 07	0aaa aaaa	Part Level (CC# 7) (0 - 127)
00 08	0aaa aaaa	Part Pan (CC# 10) (0 - 127)
00 09	0aaa aaaa	Part Coarse Tune (RPN# 2) L64 - 63R (16 - 112)
00 0A	0aaa aaaa	Part Fine Tune (RPN# 1) -48 - +48 (14 - 114)
00 0B	0000 00aa	Part Mono/Poly (MONO ON/POLY ON) MONO, POLY, PATCH (0 - 2)
00 0C	0000 00aa	Part Legato Switch (CC# 68) (0 - 2)
00 0D	000a aaaa	Part Pitch Bend Range (RPN# 0) OFF, ON, PATCH (0 - 25)
00 0E	0000 00aa	Part Portamento Switch (CC# 65) 0 - 24, PATCH (0 - 2)
# 00 0F	0000 aaaa 0000 bbbb	Part Portamento Time (CC# 5) OFF, ON, PATCH (0 - 128)
00 11	0aaa aaaa	Part Cutoff Offset (CC# 74) 0 - 127, PATCH (0 - 127)
00 12	0aaa aaaa	Part Resonance Offset (CC# 71) -64 - +63 (0 - 127)
00 13	0aaa aaaa	Part Attack Time Offset (CC# 73) -64 - +63 (0 - 127)
00 14	0aaa aaaa	Part Release Time Offset (CC# 72) -64 - +63 (0 - 127)
00 15	0000 0aaa	Part Octave Shift (61 - 67) -3 - +3
00 16	0aaa aaaa	Part Velocity Sens Offset (1 - 127) -63 - +63
00 17	0aaa aaaa	(reserve) <*>
00 18	0aaa aaaa	(reserve) <*>
00 19	0aaa aaaa	(reserve) <*>
00 1A	0aaa aaaa	(reserve) <*>
00 1B	0000 000a	Mute Switch (0 - 1) OFF, MUTE
00 1C	0aaa aaaa	Part Dry Send Level (0 - 127)
00 1D	0aaa aaaa	Part Chorus Send Level (CC# 93) (0 - 127)
00 1E	0aaa aaaa	Part Reverb Send Level (CC# 91) (0 - 127)
00 1F	0000 aaaa	Part Output Assign (0 - 13) MFx1, A, B, ---, ---
00 20	0000 00aa	Part Output MFx Select 1, 2, 3, 4, ---, ---, ---, --- PATCH (0 - 2) MFx1, MFx2, MFx3
00 21	0aaa aaaa	Part Decay Time Offset (CC# 75) (0 - 127) -64 - +63

MIDI Implementation

00 22	0aaa aaaa	Part Vibrato Rate (CC# 76)	(0 - 127)
00 23	0aaa aaaa	Part Vibrato Depth (CC# 77)	-64 - +63 (0 - 127)
00 24	0aaa aaaa	Part Vibrato Delay (CC# 78)	-64 - +63 (0 - 127)
00 25	0aaa aaaa	Part Scale Tune for C	(0 - 127)
00 26	0aaa aaaa	Part Scale Tune for C#	-64 - +63 (0 - 127)
00 27	0aaa aaaa	Part Scale Tune for D	(0 - 127)
00 28	0aaa aaaa	Part Scale Tune for D#	-64 - +63 (0 - 127)
00 29	0aaa aaaa	Part Scale Tune for E	(0 - 127)
00 2A	0aaa aaaa	Part Scale Tune for F	-64 - +63 (0 - 127)
00 2B	0aaa aaaa	Part Scale Tune for F#	(0 - 127)
00 2C	0aaa aaaa	Part Scale Tune for G	-64 - +63 (0 - 127)
00 2D	0aaa aaaa	Part Scale Tune for G#	(0 - 127)
00 2E	0aaa aaaa	Part Scale Tune for A	-64 - +63 (0 - 127)
00 2F	0aaa aaaa	Part Scale Tune for A#	(0 - 127)
00 30	0aaa aaaa	Part Scale Tune for B	-64 - +63 (0 - 127)
00 00 00 31	Total Size		

Performance Zone

Offset Address	Description	
00 00	000a aaaa	(reserve) <*>
00 01	0000 000a	Zone Switch (0 - 1)
00 02	0000 000a	(reserve) <*>
# 00 03	0000 aaaa 0000 bbbb	External Bank Select MSB (CC# 0) (0 - 128)
# 00 05	0aaa aaaa 0000 aaaa 0000 bbbb	External Bank Select LSB (CC# 32) (0 - 127)
# 00 06	0000 aaaa 0000 bbbb	External Program Number (PC) (0 - 128)
# 00 08	0000 aaaa 0000 bbbb	External Level (CC# 7) (0 - 128)
# 00 0A	0000 aaaa 0000 bbbb	External Pan (CC# 10) (0 - 128)
00 0C	0aaa aaaa	Keyboard Range Lower (0 - 127)
00 0D	0aaa aaaa	Keyboard Range Upper C-1 - UPPER (0 - 127)
00 0E	0000 000a	Control Bender (0 - 1)
00 0F	0000 000a	Control Aftertouch (0 - 1)
00 10	0000 000a	Control Modulation (0 - 1)
00 11	0000 000a	Control Hold Pedal (0 - 1)
00 12	0000 000a	Control Pedal (0 - 1)
00 13	0000 000a	(reserve) <*>
00 14	0000 000a	Control D Beam (0 - 1)
00 15	0000 000a	Control Knob 1 (0 - 1)
00 16	0000 000a	Control Knob 2 (0 - 1)
00 17	0000 000a	Control Knob 3 (0 - 1)
00 18	0000 000a	Control Knob 4 (0 - 1)
00 19	0000 000a	(reserve) <*>
00 1A	0000 000a	(reserve) <*>
00 00 00 1B	Total Size	

Performance Controller

Offset Address	Description	
00 00	0000 000a	(reserve) <*>
00 01	0aaa aaaa	Beam Assign (0 - 104)
00 02	0aaa aaaa	Beam Range Lower (0 - 127)
00 03	0aaa aaaa	Beam Range Upper (0 - 127)
00 04	0000 aaaa	Beam Trigger Pad (0 - 15)
00 05	0aaa aaaa	Beam Trigger Velo (1 - 127)
00 06	0aaa aaaa	Beam Trigger Mode (0 - 1)
00 07	0aaa aaaa	Knob 1 Assign (0 - 103)
00 08	0aaa aaaa	Knob 2 Assign (0 - 103)
00 09	0aaa aaaa	Knob 3 Assign (0 - 103)
00 0A	0aaa aaaa	Knob 4 Assign (0 - 103)
00 0B	0aaa aaaa	Switch 1 Assign (0 - 13)

00 0C	0aaa aaaa	Switch 2 Assign	MONO/POLY, PORTAMENTO, HOLD1, MFX1-SW, MFX2-SW, MFX3-SW, CHO-SW, REV-SW, MAS-SW, SEQ-LOOP, RHY-START/STOP (0 - 13)
00 0D	0000 000a	(reserve) <*>	
00 0E	0aaa aaaa	Arp/Ptn Grid	(0 - 8) 04_, 08_, 08L, 08H, 08t, 16_, 16L, 16H, 16t
00 0F	0aaa aaaa	Arp/Ptn Duration	(0 - 9) 30, 40, 50, 60, 70, 80, 90, 100, 120, FUL
00 10	0000 000a	Arpeggio Switch	(0 - 1)
00 11	0aaa aaaa	Arpeggio Bank	OFF, ON (0 - 1)
00 12	0aaa aaaa	Arpeggio Style	USER, PRESET (0 - 127)
00 13	0aaa aaaa	Arpeggio Motif	(0 - 11) UP/L, UP/H, UP/_/, dn/L, dn/H, dn/_/, U/L, U/H, U/_/, rn/L, rn/H, rn/_/, PHRASE
00 14	0000 0aaa	Arpeggio Octave Range	(61 - 67) -3 - +3
00 15	0000 000a	Arpeggio Hold	OFF, ON (0 - 1)
00 16	0aaa aaaa	Arpeggio Accent Rate	(0 - 100)
00 17	0aaa aaaa	Arpeggio Velocity	(0 - 127)
00 18	0000 aaaa	Arpeggio Zone Number	REAL, (0 - 15)
00 19	0000 000a	Rhythm Pattern Switch	ZONE1 - ZONE16 (0 - 1)
00 1A	0aaa aaaa	Rhythm Pattern Group Bank	OFF, ON (0 - 1)
00 1B	0aaa aaaa	Rhythm Pattern Group Number	USER, PRESET (0 - 31)
00 1C	0aaa aaaa	Rhythm Pattern Accent Rate	(0 - 100)
00 1D	0aaa aaaa	Rhythm Pattern Velocity	(0 - 127)
00 1E	0000 000a	Chord Switch	REAL, (0 - 1)
00 1F	0aaa aaaa	Chord Group	OFF, ON (0 - 1)
00 20	00aa aaaa	Chord Form	USER, PRESET (0 - 63)
00 21	0aaa aaaa	(reserve) <*>	
00 22	0aaa aaaa	(reserve) <*>	
00 23	000a aaaa	Pad Transmit Channel	(0 - 15)
00 24	0aaa aaaa	(reserve) <*>	
00 25	0aaa aaaa	Pad 1 Note Number	(0 - 127)
00 26	0aaa aaaa	Pad 1 Velocity	C-1 - G9 (0 - 127)
00 27	0aaa aaaa	(reserve) <*>	
00 28	0aaa aaaa	Pad 2 Note Number	(0 - 127)
00 29	0aaa aaaa	Pad 2 Velocity	C-1 - G9 (0 - 127)
00 2A	0aaa aaaa	(reserve) <*>	
00 2B	0aaa aaaa	Pad 3 Note Number	(0 - 127)
00 2C	0aaa aaaa	Pad 3 Velocity	C-1 - G9 (0 - 127)
00 2D	0aaa aaaa	(reserve) <*>	
00 2E	0aaa aaaa	Pad 4 Note Number	(0 - 127)
00 2F	0aaa aaaa	Pad 4 Velocity	C-1 - G9 (0 - 127)
00 30	0aaa aaaa	(reserve) <*>	
00 31	0aaa aaaa	Pad 5 Note Number	(0 - 127)
00 32	0aaa aaaa	Pad 5 Velocity	C-1 - G9 (0 - 127)
00 33	0aaa aaaa	(reserve) <*>	
00 34	0aaa aaaa	Pad 6 Note Number	(0 - 127)
00 35	0aaa aaaa	Pad 6 Velocity	C-1 - G9 (0 - 127)
00 36	0aaa aaaa	(reserve) <*>	
00 37	0aaa aaaa	Pad 7 Note Number	(0 - 127)
00 38	0aaa aaaa	Pad 7 Velocity	C-1 - G9 (0 - 127)
00 39	0aaa aaaa	(reserve) <*>	
00 3A	0aaa aaaa	Pad 8 Note Number	(0 - 127)
00 3B	0aaa aaaa	Pad 8 Velocity	C-1 - G9 (0 - 127)
00 3C	0aaa aaaa	(reserve) <*>	
00 3D	0aaa aaaa	Pad 9 Note Number	(0 - 127)
00 3E	0aaa aaaa	Pad 9 Velocity	C-1 - G9 (0 - 127)
00 3F	0aaa aaaa	(reserve) <*>	
00 40	0aaa aaaa	Pad 10 Note Number	(0 - 127)
00 41	0aaa aaaa	Pad 10 Velocity	C-1 - G9 (0 - 127)
00 42	0aaa aaaa	(reserve) <*>	
00 43	0aaa aaaa	Pad 11 Note Number	(0 - 127)
00 44	0aaa aaaa	Pad 11 Velocity	C-1 - G9 (0 - 127)
00 45	0aaa aaaa	(reserve) <*>	
00 46	0aaa aaaa	Pad 12 Note Number	(0 - 127)
00 47	0aaa aaaa	Pad 12 Velocity	C-1 - G9 (0 - 127)
00 48	0aaa aaaa	(reserve) <*>	
00 49	0aaa aaaa	Pad 13 Note Number	(0 - 127)
00 4A	0aaa aaaa	Pad 13 Velocity	C-1 - G9 (0 - 127)
00 4B	0aaa aaaa	(reserve) <*>	
00 4C	0aaa aaaa	Pad 14 Note Number	(0 - 127)
00 4D	0aaa aaaa	Pad 14 Velocity	C-1 - G9 (0 - 127)
00 4E	0aaa aaaa	(reserve) <*>	
00 4F	0aaa aaaa	Pad 15 Note Number	(0 - 127)
00 50	0aaa aaaa	Pad 15 Velocity	C-1 - G9 (0 - 127)
00 51	0aaa aaaa	(reserve) <*>	
00 52	0aaa aaaa	Pad 16 Note Number	(0 - 127)
00 53	0aaa aaaa	Pad 16 Velocity	C-1 - G9 (0 - 127)

MIDI Implementation

#	00 54	0000 aaaa 0000 bbbb	Recommended Tempo	(20 - 250)
	00 56	0000 000a	Rolled Chord	(0 - 1) OFF, ON
	00 57	0000 00aa	Rolled Chord Type	(0 - 2) UP, DOWN, ALTERNATE
	00 00 00 58	Total Size		

Arpeggio Common

Offset Address	Description		
# 00 00	0000 aaaa 0000 bbbb	End Step	(1 - 32)
00 02	0aaa aaaa	Arpeggio Name 1	(32 - 127)
00 03	0aaa aaaa	Arpeggio Name 2	(32 - 127)
00 04	0aaa aaaa	Arpeggio Name 3	(32 - 127)
00 05	0aaa aaaa	Arpeggio Name 4	(32 - 127)
00 06	0aaa aaaa	Arpeggio Name 5	(32 - 127)
00 07	0aaa aaaa	Arpeggio Name 6	(32 - 127)
00 08	0aaa aaaa	Arpeggio Name 7	(32 - 127)
00 09	0aaa aaaa	Arpeggio Name 8	(32 - 127)
00 0A	0aaa aaaa	Arpeggio Name 9	(32 - 127)
00 0B	0aaa aaaa	Arpeggio Name 10	(32 - 127)
00 0C	0aaa aaaa	Arpeggio Name 11	(32 - 127)
00 0D	0aaa aaaa	Arpeggio Name 12	(32 - 127)
00 0E	0aaa aaaa	Arpeggio Name 13	(32 - 127)
00 0F	0aaa aaaa	Arpeggio Name 14	(32 - 127)
00 10	0aaa aaaa	Arpeggio Name 15	(32 - 127)
00 11	0aaa aaaa	Arpeggio Name 16	(32 - 127)
00 00 00 12	Total Size		

Arpeggio Pattern

Offset Address	Description		
# 00 00	0000 aaaa 0000 bbbb	Original Note	(0 - 128)
# 00 02	0000 aaaa 0000 bbbb	Step1 Data	(0 - 128)
# 00 04	0000 aaaa 0000 bbbb	Step2 Data	(0 - 128)
# 00 06	0000 aaaa 0000 bbbb	Step3 Data	(0 - 128)
# 00 08	0000 aaaa 0000 bbbb	Step4 Data	(0 - 128)
# 00 0A	0000 aaaa 0000 bbbb	Step5 Data	(0 - 128)
# 00 0C	0000 aaaa 0000 bbbb	Step6 Data	(0 - 128)
# 00 0E	0000 aaaa 0000 bbbb	Step7 Data	(0 - 128)
# 00 10	0000 aaaa 0000 bbbb	Step8 Data	(0 - 128)
# 00 12	0000 aaaa 0000 bbbb	Step9 Data	(0 - 128)
# 00 14	0000 aaaa 0000 bbbb	Step10 Data	(0 - 128)
# 00 16	0000 aaaa 0000 bbbb	Step11 Data	(0 - 128)
# 00 18	0000 aaaa 0000 bbbb	Step12 Data	(0 - 128)
# 00 1A	0000 aaaa 0000 bbbb	Step13 Data	(0 - 128)
# 00 1C	0000 aaaa 0000 bbbb	Step14 Data	(0 - 128)
# 00 1E	0000 aaaa 0000 bbbb	Step15 Data	(0 - 128)
# 00 20	0000 aaaa 0000 bbbb	Step16 Data	(0 - 128)
# 00 22	0000 aaaa 0000 bbbb	Step17 Data	(0 - 128)
# 00 24	0000 aaaa 0000 bbbb	Step18 Data	(0 - 128)
# 00 26	0000 aaaa 0000 bbbb	Step19 Data	(0 - 128)
# 00 28	0000 aaaa 0000 bbbb	Step20 Data	(0 - 128)
# 00 2A	0000 aaaa 0000 bbbb	Step21 Data	(0 - 128)
# 00 2C	0000 aaaa 0000 bbbb	Step22 Data	(0 - 128)
# 00 2E	0000 aaaa 0000 bbbb	Step23 Data	(0 - 128)
# 00 30	0000 aaaa 0000 bbbb	Step24 Data	(0 - 128)
# 00 32	0000 aaaa 0000 bbbb	Step25 Data	(0 - 128)
# 00 34	0000 aaaa 0000 bbbb	Step26 Data	(0 - 128)
# 00 36	0000 aaaa 0000 bbbb	Step27 Data	(0 - 128)
# 00 38	0000 aaaa 0000 bbbb	Step28 Data	(0 - 128)
# 00 3A	0000 aaaa 0000 bbbb	Step29 Data	(0 - 128)
# 00 3C	0000 aaaa 0000 bbbb	Step30 Data	(0 - 128)
# 00 3E	0000 aaaa 0000 bbbb	Step31 Data	(0 - 128)
# 00 40	0000 aaaa 0000 bbbb	Step32 Data	(0 - 128)
00 00 00 42	Total Size		

Chord Pattern

Offset Address	Description
----------------	-------------

00 00	0000 000a	Chord Note1	(0 - 1) OFF, ON
00 01	0000 000a	Chord Note2	(0 - 1) OFF, ON
00 02	0000 000a	Chord Note3	(0 - 1) OFF, ON
00 03	0000 000a	Chord Note4	(0 - 1) OFF, ON
00 04	0000 000a	Chord Note5	(0 - 1) OFF, ON
00 05	0000 000a	Chord Note6	(0 - 1) OFF, ON
00 06	0000 000a	Chord Note7	(0 - 1) OFF, ON
00 07	0000 000a	Chord Note8	(0 - 1) OFF, ON
00 08	0000 000a	Chord Note9	(0 - 1) OFF, ON
00 09	0000 000a	Chord Note10	(0 - 1) OFF, ON
00 0A	0000 000a	Chord Note11	(0 - 1) OFF, ON
00 0B	0000 000a	Chord Note12	(0 - 1) OFF, ON
00 0C	0000 000a	Chord Note13	(0 - 1) OFF, ON
00 0D	0000 000a	Chord Note14	(0 - 1) OFF, ON
00 0E	0000 000a	Chord Note15	(0 - 1) OFF, ON
00 0F	0000 000a	Chord Note16	(0 - 1) OFF, ON
00 10	0000 000a	Chord Note17	(0 - 1) OFF, ON
00 11	0000 000a	Chord Note18	(0 - 1) OFF, ON
00 12	0000 000a	Chord Note19	(0 - 1) OFF, ON
00 13	0000 000a	Chord Note20	(0 - 1) OFF, ON
00 14	0000 000a	Chord Note21	(0 - 1) OFF, ON
00 15	0000 000a	Chord Note22	(0 - 1) OFF, ON
00 16	0000 000a	Chord Note23	(0 - 1) OFF, ON
00 17	0000 000a	Chord Note24	(0 - 1) OFF, ON
00 18	0000 000a	Chord Note25	(0 - 1) OFF, ON
00 19	0000 000a	Chord Note26	(0 - 1) OFF, ON
00 1A	0000 000a	Chord Note27	(0 - 1) OFF, ON
00 1B	0000 000a	Chord Note28	(0 - 1) OFF, ON
00 1C	0000 000a	Chord Note29	(0 - 1) OFF, ON
00 1D	0000 000a	Chord Note30	(0 - 1) OFF, ON
00 1E	0000 000a	Chord Note31	(0 - 1) OFF, ON
00 1F	0000 000a	Chord Note32	(0 - 1) OFF, ON
00 20	0000 000a	Chord Note33	(0 - 1) OFF, ON
00 21	0000 000a	Chord Note34	(0 - 1) OFF, ON
00 22	0000 000a	Chord Note35	(0 - 1) OFF, ON
00 23	0000 000a	Chord Note36	(0 - 1) OFF, ON
00 24	0000 000a	Chord Note37	(0 - 1) OFF, ON
00 25	0000 000a	Chord Note38	(0 - 1) OFF, ON
00 26	0000 000a	Chord Note39	(0 - 1) OFF, ON
00 27	0000 000a	Chord Note40	(0 - 1) OFF, ON
00 28	0000 000a	Chord Note41	(0 - 1) OFF, ON
00 29	0000 000a	Chord Note42	(0 - 1) OFF, ON
00 2A	0000 000a	Chord Note43	(0 - 1) OFF, ON
00 2B	0000 000a	Chord Note44	(0 - 1) OFF, ON
00 2C	0000 000a	Chord Note45	(0 - 1) OFF, ON
00 2D	0000 000a	Chord Note46	(0 - 1) OFF, ON
00 2E	0000 000a	Chord Note47	(0 - 1) OFF, ON
00 2F	0000 000a	Chord Note48	(0 - 1) OFF, ON
00 30	0000 000a	Chord Note49	(0 - 1) OFF, ON
00 31	0000 000a	Chord Note50	(0 - 1) OFF, ON
00 32	0000 000a	Chord Note51	(0 - 1) OFF, ON
00 33	0000 000a	Chord Note52	(0 - 1) OFF, ON
00 34	0000 000a	Chord Note53	(0 - 1) OFF, ON
00 35	0000 000a	Chord Note54	(0 - 1) OFF, ON
00 36	0000 000a	Chord Note55	(0 - 1) OFF, ON
00 37	0000 000a	Chord Note56	(0 - 1) OFF, ON
00 38	0000 000a	Chord Note57	(0 - 1) OFF, ON
00 39	0000 000a	Chord Note58	(0 - 1) OFF, ON
00 3A	0000 000a	Chord Note59	(0 - 1) OFF, ON
00 3B	0000 000a	Chord Note60	(0 - 1) OFF, ON
00 3C	0000 000a	Chord Note61	(0 - 1) OFF, ON
00 3D	0000 000a	Chord Note62	(0 - 1) OFF, ON
00 3E	0000 000a	Chord Note63	(0 - 1) OFF, ON
00 3F	0000 000a	Chord Note64	(0 - 1) OFF, ON
00 40	0000 000a	Chord Note65	(0 - 1) OFF, ON
00 41	0000 000a	Chord Note66	(0 - 1) OFF, ON
00 42	0000 000a	Chord Note67	(0 - 1) OFF, ON
00 43	0000 000a	Chord Note68	(0 - 1) OFF, ON
00 44	0000 000a	Chord Note69	(0 - 1) OFF, ON

MIDI Implementation

00 45	0000 000a	Chord Note70	OFF, ON (0 - 1)
00 46	0000 000a	Chord Note71	OFF, ON (0 - 1)
00 47	0000 000a	Chord Note72	OFF, ON (0 - 1)
00 48	0000 000a	Chord Note73	OFF, ON (0 - 1)
00 49	0000 000a	Chord Note74	OFF, ON (0 - 1)
00 4A	0000 000a	Chord Note75	OFF, ON (0 - 1)
00 4B	0000 000a	Chord Note76	OFF, ON (0 - 1)
00 4C	0000 000a	Chord Note77	OFF, ON (0 - 1)
00 4D	0000 000a	Chord Note78	OFF, ON (0 - 1)
00 4E	0000 000a	Chord Note79	OFF, ON (0 - 1)
00 4F	0000 000a	Chord Note80	OFF, ON (0 - 1)
00 50	0000 000a	Chord Note81	OFF, ON (0 - 1)
00 51	0000 000a	Chord Note82	OFF, ON (0 - 1)
00 52	0000 000a	Chord Note83	OFF, ON (0 - 1)
00 53	0000 000a	Chord Note84	OFF, ON (0 - 1)
00 54	0000 000a	Chord Note85	OFF, ON (0 - 1)
00 55	0000 000a	Chord Note86	OFF, ON (0 - 1)
00 56	0000 000a	Chord Note87	OFF, ON (0 - 1)
00 57	0000 000a	Chord Note88	OFF, ON (0 - 1)
00 58	0000 000a	Chord Note89	OFF, ON (0 - 1)
00 59	0000 000a	Chord Note90	OFF, ON (0 - 1)
00 5A	0000 000a	Chord Note91	OFF, ON (0 - 1)
00 5B	0000 000a	Chord Note92	OFF, ON (0 - 1)
00 5C	0000 000a	Chord Note93	OFF, ON (0 - 1)
00 5D	0000 000a	Chord Note94	OFF, ON (0 - 1)
00 5E	0000 000a	Chord Note95	OFF, ON (0 - 1)
00 5F	0000 000a	Chord Note96	OFF, ON (0 - 1)
00 60	0000 000a	Chord Note97	OFF, ON (0 - 1)
00 61	0000 000a	Chord Note98	OFF, ON (0 - 1)
00 62	0000 000a	Chord Note99	OFF, ON (0 - 1)
00 63	0000 000a	Chord Note100	OFF, ON (0 - 1)
00 64	0000 000a	Chord Note101	OFF, ON (0 - 1)
00 65	0000 000a	Chord Note102	OFF, ON (0 - 1)
00 66	0000 000a	Chord Note103	OFF, ON (0 - 1)
00 67	0000 000a	Chord Note104	OFF, ON (0 - 1)
00 68	0000 000a	Chord Note105	OFF, ON (0 - 1)
00 69	0000 000a	Chord Note106	OFF, ON (0 - 1)
00 6A	0000 000a	Chord Note107	OFF, ON (0 - 1)
00 6B	0000 000a	Chord Note108	OFF, ON (0 - 1)
00 6C	0000 000a	Chord Note109	OFF, ON (0 - 1)
00 6D	0000 000a	Chord Note110	OFF, ON (0 - 1)
00 6E	0000 000a	Chord Note111	OFF, ON (0 - 1)
00 6F	0000 000a	Chord Note112	OFF, ON (0 - 1)
00 70	0000 000a	Chord Note113	OFF, ON (0 - 1)
00 71	0000 000a	Chord Note114	OFF, ON (0 - 1)
00 72	0000 000a	Chord Note115	OFF, ON (0 - 1)
00 73	0000 000a	Chord Note116	OFF, ON (0 - 1)
00 74	0000 000a	Chord Note117	OFF, ON (0 - 1)
00 75	0000 000a	Chord Note118	OFF, ON (0 - 1)
00 76	0000 000a	Chord Note119	OFF, ON (0 - 1)
00 77	0000 000a	Chord Note120	OFF, ON (0 - 1)
00 78	0000 000a	Chord Note121	OFF, ON (0 - 1)
00 79	0000 000a	Chord Note122	OFF, ON (0 - 1)
00 7A	0000 000a	Chord Note123	OFF, ON (0 - 1)
00 7B	0000 000a	Chord Note124	OFF, ON (0 - 1)
00 7C	0000 000a	Chord Note125	OFF, ON (0 - 1)
00 7D	0000 000a	Chord Note126	OFF, ON (0 - 1)
00 7E	0000 000a	Chord Note127	OFF, ON (0 - 1)
00 7F	0000 000a	Chord Note128	OFF, ON (0 - 1)
01 00	0aaa aaaa	Chord Pattern Name 1	(32 - 127)
01 01	0aaa aaaa	Chord Pattern Name 2	(32 - 127)
01 02	0aaa aaaa	Chord Pattern Name 3	(32 - 127)
01 03	0aaa aaaa	Chord Pattern Name 4	(32 - 127)
01 04	0aaa aaaa	Chord Pattern Name 5	(32 - 127)
01 05	0aaa aaaa	Chord Pattern Name 6	(32 - 127)
01 06	0aaa aaaa	Chord Pattern Name 7	(32 - 127)
01 07	0aaa aaaa	Chord Pattern Name 8	(32 - 127)
01 08	0aaa aaaa	Chord Pattern Name 9	(32 - 127)

01 09	0aaa aaaa	Chord Pattern Name 10	(32 - 127)
01 0A	0aaa aaaa	Chord Pattern Name 11	(32 - 127)
01 0B	0aaa aaaa	Chord Pattern Name 12	(32 - 127)
01 0C	0aaa aaaa	Chord Pattern Name 13	(32 - 127)
01 0D	0aaa aaaa	Chord Pattern Name 14	(32 - 127)
01 0E	0aaa aaaa	Chord Pattern Name 15	(32 - 127)
01 0F	0aaa aaaa	Chord Pattern Name 16	(32 - 127)
00 00 01 10		Total Size	

○Rhythm Group

Offset Address	Description		
00 00	0aaa aaaa	Rhythm Group Name 1	(32 - 127)
00 01	0aaa aaaa	Rhythm Group Name 2	(32 - 127)
00 02	0aaa aaaa	Rhythm Group Name 3	(32 - 127)
00 03	0aaa aaaa	Rhythm Group Name 4	(32 - 127)
00 04	0aaa aaaa	Rhythm Group Name 5	(32 - 127)
00 05	0aaa aaaa	Rhythm Group Name 6	(32 - 127)
00 06	0aaa aaaa	Rhythm Group Name 7	(32 - 127)
00 07	0aaa aaaa	Rhythm Group Name 8	(32 - 127)
00 08	0aaa aaaa	Rhythm Group Name 9	(32 - 127)
00 09	0aaa aaaa	Rhythm Group Name 10	(32 - 127)
00 0A	0aaa aaaa	Rhythm Group Name 11	(32 - 127)
00 0B	0aaa aaaa	Rhythm Group Name 12	(32 - 127)
00 0C	0aaa aaaa	Rhythm Group Name 13	(32 - 127)
00 0D	0aaa aaaa	Rhythm Group Name 14	(32 - 127)
00 0E	0aaa aaaa	Rhythm Group Name 15	(32 - 127)
00 0F	0aaa aaaa	Rhythm Group Name 16	(32 - 127)
00 10	0aaa aaaa	Recommended Rhythm Bank Select MSB	(0 - 127)
00 11	0aaa aaaa	Recommended Rhythm Bank Select LSB	(0 - 127)
00 12	0aaa aaaa	Recommended Rhythm Program Number	(0 - 127)
00 13	0aaa aaaa	Pad 1 Mode	(0 - 2)
00 14	0aaa aaaa	Pad 1 Note Number	OFF, NOTE, PTN (0 - 127) C-1 - G9
00 15	0aaa aaaa	Pad 1 Velocity	(0 - 127)
00 16	0000 000a	Pad 1 Rhythm Pattern Group	REAL, 1 - 127 (0 - 1) USER, PRESET
# 00 17	0000 aaaa	Pad 1 Rhythm Pattern Number	(0 - 255)
00 19	0aaa aaaa	Pad 2 Mode	(0 - 2)
00 1A	0aaa aaaa	Pad 2 Note Number	OFF, NOTE, PTN (0 - 127) C-1 - G9
00 1B	0aaa aaaa	Pad 2 Velocity	(0 - 127)
00 1C	0000 000a	Pad 2 Rhythm Pattern Group	REAL, 1 - 127 (0 - 1) USER, PRESET
# 00 1D	0000 aaaa	Pad 2 Rhythm Pattern Number	(0 - 255)
00 1F	0aaa aaaa	Pad 3 Mode	(0 - 2)
00 20	0aaa aaaa	Pad 3 Note Number	OFF, NOTE, PTN (0 - 127) C-1 - G9
00 21	0aaa aaaa	Pad 3 Velocity	(0 - 127)
00 22	0000 000a	Pad 3 Rhythm Pattern Group	REAL, 1 - 127 (0 - 1) USER, PRESET
# 00 23	0000 aaaa	Pad 3 Rhythm Pattern Number	(0 - 255)
00 25	0aaa aaaa	Pad 4 Mode	(0 - 2)
00 26	0aaa aaaa	Pad 4 Note Number	OFF, NOTE, PTN (0 - 127) C-1 - G9
00 27	0aaa aaaa	Pad 4 Velocity	(0 - 127)
00 28	0000 000a	Pad 4 Rhythm Pattern Group	REAL, 1 - 127 (0 - 1) USER, PRESET
# 00 29	0000 aaaa	Pad 4 Rhythm Pattern Number	(0 - 255)
00 2B	0aaa aaaa	Pad 5 Mode	(0 - 2)
00 2C	0aaa aaaa	Pad 5 Note Number	OFF, NOTE, PTN (0 - 127) C-1 - G9
00 2D	0aaa aaaa	Pad 5 Velocity	(0 - 127)
00 2E	0000 000a	Pad 5 Rhythm Pattern Group	REAL, 1 - 127 (0 - 1) USER, PRESET
# 00 2F	0000 aaaa	Pad 5 Rhythm Pattern Number	(0 - 255)
00 31	0000 bbbb	Pad 6 Mode	(0 - 2)
00 32	0aaa aaaa	Pad 6 Note Number	OFF, NOTE, PTN (0 - 127) C-1 - G9
00 33	0aaa aaaa	Pad 6 Velocity	(0 - 127)
00 34	0000 000a	Pad 6 Rhythm Pattern Group	REAL, 1 - 127 (0 - 1) USER, PRESET
# 00 35	0000 aaaa	Pad 6 Rhythm Pattern Number	(0 - 255)
00 37	0000 bbbb	Pad 7 Mode	(0 - 2)
00 38	0aaa aaaa	Pad 7 Note Number	OFF, NOTE, PTN (0 - 127) C-1 - G9
00 39	0aaa aaaa	Pad 7 Velocity	(0 - 127)
00 3A	0000 000a	Pad 7 Rhythm Pattern Group	REAL, 1 - 127 (0 - 1) USER, PRESET
# 00 3B	0000 aaaa	Pad 7 Rhythm Pattern Number	(0 - 255)
00 3D	0aaa aaaa	Pad 8 Mode	(0 - 2)
00 3E	0aaa aaaa	Pad 8 Note Number	OFF, NOTE, PTN (0 - 127) C-1 - G9
00 3F	0aaa aaaa	Pad 8 Velocity	(0 - 127)
00 40	0000 000a	Pad 8 Rhythm Pattern Group	REAL, 1 - 127 (0 - 1) USER, PRESET

MIDI Implementation

#	Offset	Address	Description	Range	Default	Parameter
			USER, PRESET			
#	00 41	0000 aaaa	Pad 8 Rhythm Pattern Number	(0 - 255)		
	00 43	0000 bbbb	Pad 9 Mode	(0 - 2)		
	00 44	0000 aaaa	Pad 9 Note Number	OFF, NOTE, PTN		
	00 45	0000 aaaa	Pad 9 Velocity	(0 - 127)		
	00 46	0000 000a	Pad 9 Rhythm Pattern Group	C-1 - G9		
#	00 47	0000 aaaa	Pad 9 Rhythm Pattern Number	(0 - 255)		
	00 49	0000 bbbb	Pad 10 Mode	(0 - 2)		
	00 4A	0000 aaaa	Pad 10 Note Number	OFF, NOTE, PTN		
	00 4B	0000 aaaa	Pad 10 Velocity	(0 - 127)		
	00 4C	0000 000a	Pad 10 Rhythm Pattern Group	C-1 - G9		
#	00 4D	0000 aaaa	Pad 10 Rhythm Pattern Number	(0 - 255)		
	00 4F	0000 aaaa	Pad 11 Mode	(0 - 2)		
	00 50	0000 aaaa	Pad 11 Note Number	OFF, NOTE, PTN		
	00 51	0000 aaaa	Pad 11 Velocity	(0 - 127)		
	00 52	0000 000a	Pad 11 Rhythm Pattern Group	C-1 - G9		
#	00 53	0000 aaaa	Pad 11 Rhythm Pattern Number	(0 - 255)		
	00 55	0000 bbbb	Pad 12 Mode	(0 - 2)		
	00 56	0000 aaaa	Pad 12 Note Number	OFF, NOTE, PTN		
	00 57	0000 aaaa	Pad 12 Velocity	(0 - 127)		
	00 58	0000 000a	Pad 12 Rhythm Pattern Group	C-1 - G9		
#	00 59	0000 aaaa	Pad 12 Rhythm Pattern Number	(0 - 255)		
	00 5B	0000 aaaa	Pad 13 Mode	(0 - 2)		
	00 5C	0000 aaaa	Pad 13 Note Number	OFF, NOTE, PTN		
	00 5D	0000 aaaa	Pad 13 Velocity	(0 - 127)		
	00 5E	0000 000a	Pad 13 Rhythm Pattern Group	C-1 - G9		
#	00 5F	0000 aaaa	Pad 13 Rhythm Pattern Number	(0 - 255)		
	00 61	0000 aaaa	Pad 14 Mode	(0 - 2)		
	00 62	0000 aaaa	Pad 14 Note Number	OFF, NOTE, PTN		
	00 63	0000 aaaa	Pad 14 Velocity	(0 - 127)		
	00 64	0000 000a	Pad 14 Rhythm Pattern Group	C-1 - G9		
#	00 65	0000 aaaa	Pad 14 Rhythm Pattern Number	(0 - 255)		
	00 67	0000 bbbb	Pad 15 Mode	(0 - 2)		
	00 68	0000 aaaa	Pad 15 Note Number	OFF, NOTE, PTN		
	00 69	0000 aaaa	Pad 15 Velocity	(0 - 127)		
	00 6A	0000 000a	Pad 15 Rhythm Pattern Group	C-1 - G9		
#	00 6B	0000 aaaa	Pad 15 Rhythm Pattern Number	(0 - 255)		
	00 6D	0000 bbbb	Pad 16 Mode	(0 - 2)		
	00 6E	0000 aaaa	Pad 16 Note Number	OFF, NOTE, PTN		
	00 6F	0000 aaaa	Pad 16 Velocity	(0 - 127)		
	00 70	0000 000a	Pad 16 Rhythm Pattern Group	C-1 - G9		
#	00 71	0000 aaaa	Pad 16 Rhythm Pattern Number	(0 - 255)		
	00 00 00 73	Total Size				

○Patch Common

Offset	Address	Description	Range	Default	Parameter
00 00	0aaa aaaa	Patch Name 1	(32 - 127) [ASCII]		
00 01	0aaa aaaa	Patch Name 2	(32 - 127) [ASCII]		
00 02	0aaa aaaa	Patch Name 3	(32 - 127) [ASCII]		
00 03	0aaa aaaa	Patch Name 4	(32 - 127) [ASCII]		
00 04	0aaa aaaa	Patch Name 5	(32 - 127) [ASCII]		
00 05	0aaa aaaa	Patch Name 6	(32 - 127) [ASCII]		
00 06	0aaa aaaa	Patch Name 7	(32 - 127) [ASCII]		
00 07	0aaa aaaa	Patch Name 8	(32 - 127) [ASCII]		
00 08	0aaa aaaa	Patch Name 9	(32 - 127) [ASCII]		
00 09	0aaa aaaa	Patch Name 10	(32 - 127) [ASCII]		
00 0A	0aaa aaaa	Patch Name 11	(32 - 127) [ASCII]		
00 0B	0aaa aaaa	Patch Name 12	(32 - 127) [ASCII]		
00 0C	0aaa aaaa	Patch Category	(0 - 127)		
00 0D	0000 000a	(reserve) <*>			
00 0E	0aaa aaaa	Patch Level	(0 - 127)		
00 0F	0aaa aaaa	Patch Pan	(0 - 127)		
00 10	0000 000a	Patch Priority	L64 - 63R		
00 11	0aaa aaaa	Patch Coarse Tune	(0 - 1)		
00 12	0aaa aaaa	Patch Fine Tune	LAST, LOUDEST		
00 13	0000 0aaa	Octave Shift	(16 - 112)		
00 14	0000 00aa	Stretch Tune Depth	(-48 - +48)		
00 15	0aaa aaaa	Analog Feel	(14 - 114)		
00 16	0000 000a	Mono/Poly	(-50 - +50)		
00 17	0000 000a	Legato Switch	(61 - 67)		
			(-3 - +3)		
			(0 - 3)		
			OFF, 1 - 3		
			(0 - 127)		
			(0 - 1)		
			MONO, POLY		
			(0 - 1)		

MIDI Implementation

00 3A	0aaa aaaa	Matrix Control 2 Sens 3	(1 - 127) -63 - +63
00 3B	00aa aaaa	Matrix Control 2 Destination 4	(0 - 34) OFF, PCH, CUT, RES, LEV, PAN, DRY, CHO, REV, PIT-LFO1, PIT-LFO2, TVF-LFO1, TVF-LFO2, TVA-LFO1, TVA-LFO2, PAN-LFO1, PAN-LFO2, LFO1-RATE, LFO2-RATE, PIT-ATK, PIT-DCY, PIT-REL, TVF-ATK, TVF-DCY, TVF-REL, TVA-ATK, TVA-DCY, TVA-REL, TMT, FXM, MFX1, MFX2, MFX3, MFX4, TIME
00 3C	0aaa aaaa	Matrix Control 2 Sens 4	(1 - 127) -63 - +63
00 3D	0aaa aaaa	Matrix Control 3 Source	(0 - 109) OFF, CC01 - CC31, CC33 - CC95, BEND, APT, SYS1 - SYS4, VELOCITY, KEYFOLLOW, TEMPO, LFO1, LFO2, PIT-ENV, TVF-ENV, TVA-ENV
00 3E	00aa aaaa	Matrix Control 3 Destination 1	(0 - 34) OFF, PCH, CUT, RES, LEV, PAN, DRY, CHO, REV, PIT-LFO1, PIT-LFO2, TVF-LFO1, TVF-LFO2, TVA-LFO1, TVA-LFO2, PAN-LFO1, PAN-LFO2, LFO1-RATE, LFO2-RATE, PIT-ATK, PIT-DCY, PIT-REL, TVF-ATK, TVF-DCY, TVF-REL, TVA-ATK, TVA-DCY, TVA-REL, TMT, FXM, MFX1, MFX2, MFX3, MFX4, TIME
00 3F	0aaa aaaa	Matrix Control 3 Sens 1	(1 - 127) -63 - +63
00 40	00aa aaaa	Matrix Control 3 Destination 2	(0 - 34) OFF, PCH, CUT, RES, LEV, PAN, DRY, CHO, REV, PIT-LFO1, PIT-LFO2, TVF-LFO1, TVF-LFO2, TVA-LFO1, TVA-LFO2, PAN-LFO1, PAN-LFO2, LFO1-RATE, LFO2-RATE, PIT-ATK, PIT-DCY, PIT-REL, TVF-ATK, TVF-DCY, TVF-REL, TVA-ATK, TVA-DCY, TVA-REL, TMT, FXM, MFX1, MFX2, MFX3, MFX4, TIME
00 41	0aaa aaaa	Matrix Control 3 Sens 2	(1 - 127) -63 - +63
00 42	00aa aaaa	Matrix Control 3 Destination 3	(0 - 34) OFF, PCH, CUT, RES, LEV, PAN, DRY, CHO, REV, PIT-LFO1, PIT-LFO2, TVF-LFO1, TVF-LFO2, TVA-LFO1, TVA-LFO2, PAN-LFO1, PAN-LFO2, LFO1-RATE, LFO2-RATE, PIT-ATK, PIT-DCY, PIT-REL, TVF-ATK, TVF-DCY, TVF-REL, TVA-ATK, TVA-DCY, TVA-REL, TMT, FXM, MFX1, MFX2, MFX3, MFX4, TIME
00 43	0aaa aaaa	Matrix Control 3 Sens 3	(1 - 127) -63 - +63
00 44	00aa aaaa	Matrix Control 3 Destination 4	(0 - 34) OFF, PCH, CUT, RES, LEV, PAN, DRY, CHO, REV, PIT-LFO1, PIT-LFO2, TVF-LFO1, TVF-LFO2, TVA-LFO1, TVA-LFO2, PAN-LFO1, PAN-LFO2, LFO1-RATE, LFO2-RATE, PIT-ATK, PIT-DCY, PIT-REL, TVF-ATK, TVF-DCY, TVF-REL, TVA-ATK, TVA-DCY, TVA-REL, TMT, FXM, MFX1, MFX2, MFX3, MFX4, TIME
00 45	0aaa aaaa	Matrix Control 3 Sens 4	(1 - 127) -63 - +63
00 46	0aaa aaaa	Matrix Control 4 Source	(0 - 109) OFF, CC01 - CC31, CC33 - CC95, BEND, APT, SYS1 - SYS4, VELOCITY, KEYFOLLOW, TEMPO, LFO1, LFO2, PIT-ENV, TVF-ENV, TVA-ENV
00 47	00aa aaaa	Matrix Control 4 Destination 1	(0 - 34) OFF, PCH, CUT, RES, LEV, PAN, DRY, CHO, REV, PIT-LFO1, PIT-LFO2, TVF-LFO1, TVF-LFO2, TVA-LFO1, TVA-LFO2, PAN-LFO1, PAN-LFO2, LFO1-RATE, LFO2-RATE, PIT-ATK, PIT-DCY, PIT-REL, TVF-ATK, TVF-DCY, TVF-REL, TVA-ATK, TVA-DCY, TVA-REL, TMT, FXM, MFX1, MFX2, MFX3, MFX4, TIME
00 48	0aaa aaaa	Matrix Control 4 Sens 1	(1 - 127) -63 - +63
00 49	00aa aaaa	Matrix Control 4 Destination 2	(0 - 34) OFF, PCH, CUT, RES, LEV, PAN, DRY, CHO, REV, PIT-LFO1, PIT-LFO2, TVF-LFO1, TVF-LFO2, TVA-LFO1, TVA-LFO2, PAN-LFO1, PAN-LFO2, LFO1-RATE, LFO2-RATE, PIT-ATK, PIT-DCY, PIT-REL, TVF-ATK, TVF-DCY, TVF-REL, TVA-ATK, TVA-DCY, TVA-REL, TMT, FXM, MFX1, MFX2, MFX3, MFX4, TIME
00 4A	0aaa aaaa	Matrix Control 4 Sens 2	(1 - 127) -63 - +63
00 4B	00aa aaaa	Matrix Control 4 Destination 3	(0 - 34) OFF, PCH, CUT, RES, LEV, PAN, DRY, CHO, REV, PIT-LFO1, PIT-LFO2, TVF-LFO1, TVF-LFO2, TVA-LFO1, TVA-LFO2, PAN-LFO1, PAN-LFO2, LFO1-RATE, LFO2-RATE, PIT-ATK, PIT-DCY, PIT-REL, TVF-ATK, TVF-DCY, TVF-REL, TVA-ATK, TVA-DCY, TVA-REL, TMT, FXM, MFX1, MFX2, MFX3, MFX4, TIME
00 4C	0aaa aaaa	Matrix Control 4 Sens 3	(1 - 127) -63 - +63
00 4D	00aa aaaa	Matrix Control 4 Destination 4	(0 - 34) OFF, PCH, CUT, RES, LEV, PAN, DRY, CHO, REV, PIT-LFO1, PIT-LFO2, TVF-LFO1, TVF-LFO2, TVA-LFO1, TVA-LFO2, PAN-LFO1, PAN-LFO2, LFO1-RATE, LFO2-RATE, PIT-ATK, PIT-DCY, PIT-REL, TVF-ATK, TVF-DCY, TVF-REL, TVA-ATK, TVA-DCY, TVA-REL, TMT, FXM, MFX1, MFX2, MFX3, MFX4, TIME
00 4E	0aaa aaaa	Matrix Control 4 Sens 4	(1 - 127) -63 - +63
00 00 00 4F	Total Size		

○Patch Common MFX

Offset Address	Description	
00 00	0aaa aaaa	MFX Type (0 - 127)
00 01	0aaa aaaa	MFX Dry Send Level (0 - 127)
00 02	0aaa aaaa	MFX Chorus Send Level (0 - 127)
00 03	0aaa aaaa	MFX Reverb Send Level (0 - 127)
00 04	0000 00aa	MFX Output Assign (0 - 3) A, B, ---, ---
00 05	0aaa aaaa	MFX Control 1 Source (0 - 101) OFF, CC01 - CC31, CC33 - CC95, BEND, APT, SYS1 - SYS4
00 06	0aaa aaaa	MFX Control 1 Sens (1 - 127) -63 - +63
00 07	0aaa aaaa	MFX Control 2 Source (0 - 101) OFF, CC01 - CC31, CC33 - CC95, BEND, APT, SYS1 - SYS4
00 08	0aaa aaaa	MFX Control 2 Sens (1 - 127) -63 - +63
00 09	0aaa aaaa	MFX Control 3 Source (0 - 101) OFF, CC01 - CC31, CC33 - CC95, BEND, APT, SYS1 - SYS4
00 0A	0aaa aaaa	MFX Control 3 Sens (1 - 127) -63 - +63
00 0B	0aaa aaaa	MFX Control 4 Source (0 - 101) OFF, CC01 - CC31, CC33 - CC95, BEND, APT, SYS1 - SYS4
00 0C	0aaa aaaa	MFX Control 4 Sens (1 - 127) -63 - +63
00 0D	000a aaaa	MFX Control Assign 1 (0 - 16) OFF, 1 - 16
00 0E	000a aaaa	MFX Control Assign 2 (0 - 16) OFF, 1 - 16
00 0F	000a aaaa	MFX Control Assign 3 (0 - 16) OFF, 1 - 16
00 10	000a aaaa	MFX Control Assign 4 (0 - 16) OFF, 1 - 16
# 00 11	0000 aaaa 0000 bbbb 0000 cccc 0000 dddd	MFX Parameter 1 (12768 - 52768) -20000 - +20000
# 00 15	0000 aaaa 0000 bbbb 0000 cccc 0000 dddd	MFX Parameter 2 (12768 - 52768) -20000 - +20000
# 00 19	0000 aaaa 0000 bbbb 0000 cccc 0000 dddd	MFX Parameter 3 (12768 - 52768) -20000 - +20000
# 00 1D	0000 aaaa 0000 bbbb 0000 cccc 0000 dddd	MFX Parameter 4 (12768 - 52768) -20000 - +20000
# 00 21	0000 aaaa 0000 bbbb 0000 cccc 0000 dddd	MFX Parameter 5 (12768 - 52768) -20000 - +20000
# 00 25	0000 aaaa 0000 bbbb 0000 cccc 0000 dddd	MFX Parameter 6 (12768 - 52768) -20000 - +20000
# 00 29	0000 aaaa 0000 bbbb 0000 cccc 0000 dddd	MFX Parameter 7 (12768 - 52768) -20000 - +20000
# 00 2D	0000 aaaa 0000 bbbb 0000 cccc 0000 dddd	MFX Parameter 8 (12768 - 52768) -20000 - +20000
# 00 31	0000 aaaa 0000 bbbb 0000 cccc 0000 dddd	MFX Parameter 9 (12768 - 52768) -20000 - +20000
# 00 35	0000 aaaa 0000 bbbb 0000 cccc 0000 dddd	MFX Parameter 10 (12768 - 52768) -20000 - +20000
# 00 39	0000 aaaa 0000 bbbb 0000 cccc 0000 dddd	MFX Parameter 11 (12768 - 52768) -20000 - +20000
# 00 3D	0000 aaaa 0000 bbbb 0000 cccc 0000 dddd	MFX Parameter 12 (12768 - 52768) -20000 - +20000
# 00 41	0000 aaaa 0000 bbbb 0000 cccc 0000 dddd	MFX Parameter 13 (12768 - 52768) -20000 - +20000
# 00 45	0000 aaaa 0000 bbbb 0000 cccc 0000 dddd	MFX Parameter 14 (12768 - 52768) -20000 - +20000
# 00 49	0000 aaaa 0000 bbbb 0000 cccc 0000 dddd	MFX Parameter 15 (12768 - 52768) -20000 - +20000
# 00 4D	0000 aaaa 0000 bbbb 0000 cccc 0000 dddd	MFX Parameter 16 (12768 - 52768) -20000 - +20000
# 00 51	0000 aaaa 0000 bbbb 0000 cccc 0000 dddd	MFX Parameter 17 (12768 - 52768) -20000 - +20000
# 00 55	0000 aaaa 0000 bbbb 0000 cccc 0000 dddd	MFX Parameter 18 (12768 - 52768) -20000 - +20000
# 00 59	0000 aaaa 0000 bbbb 0000 cccc 0000 dddd	MFX Parameter 19 (12768 - 52768) -20000 - +20000
# 00 5D	0000 aaaa 0000 bbbb 0000 cccc 0000 dddd	MFX Parameter 20 (12768 - 52768)

MIDI Implementation

#	00 47	0000 dddd 0000 aaaa 0000 bbbb 0000 cccc 0000 dddd	Reverb Parameter 17 Reverb Parameter 18	(12768 - 52768) -20000 - +20000 (12768 - 52768) -20000 - +20000
#	00 4B	0000 aaaa 0000 bbbb 0000 cccc 0000 dddd	Reverb Parameter 19	(12768 - 52768) -20000 - +20000
#	00 4F	0000 aaaa 0000 bbbb 0000 cccc 0000 dddd	Reverb Parameter 20	(12768 - 52768) -20000 - +20000
	00 00 00 53	Total Size		

○Patch TMT (Tone Mix Table)

Offset Address	Description	
00 00	0000 aaaa	Structure Type 1 & 2 (0 - 9) 1 - 10
00 01	0000 00aa	Booster 1 & 2 (0 - 3) 0, +6, +12, +18 [dB]
00 02	0000 aaaa	Structure Type 3 & 4 (0 - 9) 1 - 10
00 03	0000 00aa	Booster 3 & 4 (0 - 3) 0, +6, +12, +18 [dB]
00 04	0000 00aa	TMT Velocity Control (0 - 3) OFF, ON, RANDOM, CYCLE
00 05	0000 000a	TMT1 Tone Switch (0 - 1) OFF, ON
00 06	0aaa aaaa	TMT1 Keyboard Range Lower (0 - 127) C-1 - UPPER
00 07	0aaa aaaa	TMT1 Keyboard Range Upper (0 - 127) LOWER - G9
00 08	0aaa aaaa	TMT1 Keyboard Fade Width Lower (0 - 127)
00 09	0aaa aaaa	TMT1 Keyboard Fade Width Upper (0 - 127)
00 0A	0aaa aaaa	TMT1 Velocity Range Lower (1 - 127) 1 - UPPER
00 0B	0aaa aaaa	TMT1 Velocity Range Upper (1 - 127) LOWER - 127
00 0C	0aaa aaaa	TMT1 Velocity Fade Width Lower (0 - 127)
00 0D	0aaa aaaa	TMT1 Velocity Fade Width Upper (0 - 127)
00 0E	0000 000a	TMT2 Tone Switch (0 - 1) OFF, ON
00 0F	0aaa aaaa	TMT2 Keyboard Range Lower (0 - 127) C-1 - UPPER
00 10	0aaa aaaa	TMT2 Keyboard Range Upper (0 - 127) LOWER - G9
00 11	0aaa aaaa	TMT2 Keyboard Fade Width Lower (0 - 127)
00 12	0aaa aaaa	TMT2 Keyboard Fade Width Upper (0 - 127)
00 13	0aaa aaaa	TMT2 Velocity Range Lower (1 - 127) 1 - UPPER
00 14	0aaa aaaa	TMT2 Velocity Range Upper (1 - 127) LOWER - 127
00 15	0aaa aaaa	TMT2 Velocity Fade Width Lower (0 - 127)
00 16	0aaa aaaa	TMT2 Velocity Fade Width Upper (0 - 127)
00 17	0000 000a	TMT3 Tone Switch (0 - 1) OFF, ON
00 18	0aaa aaaa	TMT3 Keyboard Range Lower (0 - 127) C-1 - UPPER
00 19	0aaa aaaa	TMT3 Keyboard Range Upper (0 - 127) LOWER - G9
00 1A	0aaa aaaa	TMT3 Keyboard Fade Width Lower (0 - 127)
00 1B	0aaa aaaa	TMT3 Keyboard Fade Width Upper (0 - 127)
00 1C	0aaa aaaa	TMT3 Velocity Range Lower (1 - 127) 1 - UPPER
00 1D	0aaa aaaa	TMT3 Velocity Range Upper (1 - 127) LOWER - 127
00 1E	0aaa aaaa	TMT3 Velocity Fade Width Lower (0 - 127)
00 1F	0aaa aaaa	TMT3 Velocity Fade Width Upper (0 - 127)
00 20	0000 000a	TMT4 Tone Switch (0 - 1) OFF, ON
00 21	0aaa aaaa	TMT4 Keyboard Range Lower (0 - 127) C-1 - UPPER
00 22	0aaa aaaa	TMT4 Keyboard Range Upper (0 - 127) LOWER - G9
00 23	0aaa aaaa	TMT4 Keyboard Fade Width Lower (0 - 127)
00 24	0aaa aaaa	TMT4 Keyboard Fade Width Upper (0 - 127)
00 25	0aaa aaaa	TMT4 Velocity Range Lower (1 - 127) 1 - UPPER
00 26	0aaa aaaa	TMT4 Velocity Range Upper (1 - 127) LOWER - 127
00 27	0aaa aaaa	TMT4 Velocity Fade Width Lower (0 - 127)
00 28	0aaa aaaa	TMT4 Velocity Fade Width Upper (0 - 127)
00 00 00 29	Total Size	

○Patch Tone

Offset Address	Description	
00 00	0aaa aaaa	Tone Level (0 - 127)
00 01	0aaa aaaa	Tone Coarse Tune (16 - 112) -48 - +48
00 02	0aaa aaaa	Tone Fine Tune (14 - 114) -50 - +50
00 03	000a aaaa	Tone Random Pitch Depth (0 - 30) 0, 1, 2, 3, 4, 5, 6, 7, 8, 9, 10, 20, 30, 40, 50, 60, 70, 80, 90, 100, 200, 300, 400, 500, 600, 700, 800, 900, 1000, 1200
00 04	0aaa aaaa	Tone Pan (0 - 127) L64 - 63R
00 05	000a aaaa	Tone Pan Keyfollow (54 - 74) -100 - +100
00 06	00aa aaaa	Tone Random Pan Depth (0 - 63)
00 07	0aaa aaaa	Tone Alternate Pan Depth (1 - 127) L63 - 63R
00 08	0000 000a	Tone Env Mode (0 - 1) NO-SUS, SUSTAIN
00 09	0000 00aa	Tone Delay Mode (0 - 3) NORMAL, HOLD, KEY-OFF-NORMAL, KEY-OFF-DECAY
# 00 0A	0000 aaaa 0000 bbbb	Tone Delay Time (0 - 149) 0 - 127, MUSICAL-NOTES
00 0C	0aaa aaaa	Tone Dry Send Level (0 - 127)
00 0D	0aaa aaaa	Tone Chorus Send Level (MFX) (0 - 127)
00 0E	0aaa aaaa	Tone Reverb Send Level (MFX) (0 - 127)

00 0F	0aaa aaaa	Tone Chorus Send Level (non MFX) (0 - 127)
00 10	0aaa aaaa	Tone Reverb Send Level (non MFX) (0 - 127)
00 11	0000 aaaa	Tone Output Assign (0 - 12) 1, 2, 3, 4, MFX, A, B, ---, ---, ---
00 12	0000 000a	Tone Receive Bender (0 - 1) OFF, ON
00 13	0000 000a	Tone Receive Expression (0 - 1) OFF, ON
00 14	0000 000a	Tone Receive Hold-1 (0 - 1) OFF, ON
00 15	0000 000a	Tone Receive Pan Mode (0 - 1) CONTINUOUS, KEY-ON
00 16	0000 000a	Tone Redamper Switch (0 - 1) OFF, ON
00 17	0000 00aa	Tone Control 1 Switch 1 (0 - 2) OFF, ON, REVERSE
00 18	0000 00aa	Tone Control 1 Switch 2 (0 - 2) OFF, ON, REVERSE
00 19	0000 00aa	Tone Control 1 Switch 3 (0 - 2) OFF, ON, REVERSE
00 1A	0000 00aa	Tone Control 1 Switch 4 (0 - 2) OFF, ON, REVERSE
00 1B	0000 00aa	Tone Control 2 Switch 1 (0 - 2) OFF, ON, REVERSE
00 1C	0000 00aa	Tone Control 2 Switch 2 (0 - 2) OFF, ON, REVERSE
00 1D	0000 00aa	Tone Control 2 Switch 3 (0 - 2) OFF, ON, REVERSE
00 1E	0000 00aa	Tone Control 2 Switch 4 (0 - 2) OFF, ON, REVERSE
00 1F	0000 00aa	Tone Control 3 Switch 1 (0 - 2) OFF, ON, REVERSE
00 20	0000 00aa	Tone Control 3 Switch 2 (0 - 2) OFF, ON, REVERSE
00 21	0000 00aa	Tone Control 3 Switch 3 (0 - 2) OFF, ON, REVERSE
00 22	0000 00aa	Tone Control 3 Switch 4 (0 - 2) OFF, ON, REVERSE
00 23	0000 00aa	Tone Control 4 Switch 1 (0 - 2) OFF, ON, REVERSE
00 24	0000 00aa	Tone Control 4 Switch 2 (0 - 2) OFF, ON, REVERSE
00 25	0000 00aa	Tone Control 4 Switch 3 (0 - 2) OFF, ON, REVERSE
00 26	0000 00aa	Tone Control 4 Switch 4 (0 - 2) OFF, ON, REVERSE
00 27	0000 00aa	Wave Group Type (0 - 3) INT, SRX, SAMPLE, MULTISAMPLE
# 00 28	0000 aaaa 0000 bbbb 0000 cccc 0000 dddd	Wave Group ID (0 - 16384) OFF, 1 - 16384
# 00 2C	0000 aaaa 0000 bbbb 0000 cccc 0000 dddd	Wave Number L (Mono) (0 - 16384) OFF, 1 - 16384
# 00 30	0000 aaaa 0000 bbbb 0000 cccc 0000 dddd	Wave Number R (0 - 16384) OFF, 1 - 16384
00 34	0000 00aa	Wave Gain (-6, 0, +6, +12 [dB])
00 35	0000 000a	Wave FXM Switch (0 - 1) OFF, ON
00 36	0000 00aa	Wave FXM Color (0 - 3) 1 - 4
00 37	000a aaaa	Wave FXM Depth (0 - 16)
00 38	0000 000a	Wave Tempo Sync (0 - 1) OFF, ON
00 39	00aa aaaa	Wave Pitch Keyfollow (44 - 84) -200 - +200
00 3A	000a aaaa	Pitch Env Depth (52 - 76) -12 - +12
00 3B	0aaa aaaa	Pitch Env Velocity Sens (1 - 127) -53 - +63
00 3C	0aaa aaaa	Pitch Env Time 1 Velocity Sens (1 - 127) -63 - +63
00 3D	0aaa aaaa	Pitch Env Time 4 Velocity Sens (1 - 127) -63 - +63
00 3E	000a aaaa	Pitch Env Time Keyfollow (54 - 74) -100 - +100
00 3F	0aaa aaaa	Pitch Env Time 1 (0 - 127)
00 40	0aaa aaaa	Pitch Env Time 2 (0 - 127)
00 41	0aaa aaaa	Pitch Env Time 3 (0 - 127)
00 42	0aaa aaaa	Pitch Env Time 4 (0 - 127)
00 43	0aaa aaaa	Pitch Env Level 0 (1 - 127) -53 - +63
00 44	0aaa aaaa	Pitch Env Level 1 (1 - 127) -63 - +63
00 45	0aaa aaaa	Pitch Env Level 2 (1 - 127) -63 - +63
00 46	0aaa aaaa	Pitch Env Level 3 (1 - 127) -63 - +63
00 47	0aaa aaaa	Pitch Env Level 4 (1 - 127) -63 - +63
00 48	0000 0aaa	TVF Filter Type (0 - 6) OFF, LPF, BPF, HPF, PKG, LFP2, LFP3
00 49	0aaa aaaa	TVF Cutoff Frequency (0 - 127)
00 4A	00aa aaaa	TVF Cutoff Keyfollow (44 - 84) -200 - +200
00 4B	0000 0aaa	TVF Cutoff Velocity Curve (0 - 7) FIXED, 1 - 7
00 4C	0aaa aaaa	TVF Cutoff Velocity Sens (1 - 127) -63 - +63
00 4D	0aaa aaaa	TVF Resonance (0 - 127)
00 4E	0aaa aaaa	TVF Resonance Velocity Sens (1 - 127) -63 - +63
00 4F	0aaa aaaa	TVF Env Depth (1 - 127) -53 - +63
00 50	0000 0aaa	TVF Env Velocity Curve (0 - 7) FIXED, 1 - 7
00 51	0aaa aaaa	TVF Env Velocity Sens (1 - 127) -63 - +63
00 52	0aaa aaaa	TVF Env Time 1 Velocity Sens (1 - 127) -63 - +63
00 53	0aaa aaaa	TVF Env Time 4 Velocity Sens (1 - 127) -63 - +63
00 54	000a aaaa	TVF Env Time Keyfollow (54 - 74) -100 - +100
00 55	0aaa aaaa	TVF Env Time 1 (0 - 127)
00 56	0aaa aaaa	TVF Env Time 2 (0 - 127)
00 57	0aaa aaaa	TVF Env Time 3 (0 - 127)
00 58	0aaa aaaa	TVF Env Time 4 (0 - 127)
00 59	0aaa aaaa	TVF Env Level 0 (0 - 127)
00 5A	0aaa aaaa	TVF Env Level 1 (0 - 127)
00 5B	0aaa aaaa	TVF Env Level 2 (0 - 127)
00 5C	0aaa aaaa	TVF Env Level 3 (0 - 127)
00 5D	0aaa aaaa	TVF Env Level 4 (0 - 127)

MIDI Implementation

#	00 4D	0000 aaaa 0000 bbbb 0000 cccc 0000 dddd	MFX Parameter 16	(12768 - 52768) -20000 - +20000
#	00 51	0000 aaaa 0000 bbbb 0000 cccc 0000 dddd	MFX Parameter 17	(12768 - 52768) -20000 - +20000
#	00 55	0000 aaaa 0000 bbbb 0000 cccc 0000 dddd	MFX Parameter 18	(12768 - 52768) -20000 - +20000
#	00 59	0000 aaaa 0000 bbbb 0000 cccc 0000 dddd	MFX Parameter 19	(12768 - 52768) -20000 - +20000
#	00 5D	0000 aaaa 0000 bbbb 0000 cccc 0000 dddd	MFX Parameter 20	(12768 - 52768) -20000 - +20000
#	00 61	0000 aaaa 0000 bbbb 0000 cccc 0000 dddd	MFX Parameter 21	(12768 - 52768) -20000 - +20000
#	00 65	0000 aaaa 0000 bbbb 0000 cccc 0000 dddd	MFX Parameter 22	(12768 - 52768) -20000 - +20000
#	00 69	0000 aaaa 0000 bbbb 0000 cccc 0000 dddd	MFX Parameter 23	(12768 - 52768) -20000 - +20000
#	00 6D	0000 aaaa 0000 bbbb 0000 cccc 0000 dddd	MFX Parameter 24	(12768 - 52768) -20000 - +20000
#	00 71	0000 aaaa 0000 bbbb 0000 cccc 0000 dddd	MFX Parameter 25	(12768 - 52768) -20000 - +20000
#	00 75	0000 aaaa 0000 bbbb 0000 cccc 0000 dddd	MFX Parameter 26	(12768 - 52768) -20000 - +20000
#	00 79	0000 aaaa 0000 bbbb 0000 cccc 0000 dddd	MFX Parameter 27	(12768 - 52768) -20000 - +20000
#	00 7D	0000 aaaa 0000 bbbb 0000 cccc 0000 dddd	MFX Parameter 28	(12768 - 52768) -20000 - +20000
#	01 01	0000 aaaa 0000 bbbb 0000 cccc 0000 dddd	MFX Parameter 29	(12768 - 52768) -20000 - +20000
#	01 05	0000 aaaa 0000 bbbb 0000 cccc 0000 dddd	MFX Parameter 30	(12768 - 52768) -20000 - +20000
#	01 09	0000 aaaa 0000 bbbb 0000 cccc 0000 dddd	MFX Parameter 31	(12768 - 52768) -20000 - +20000
#	01 0D	0000 aaaa 0000 bbbb 0000 cccc 0000 dddd	MFX Parameter 32	(12768 - 52768) -20000 - +20000
00 00 01 11		Total Size		

○Rhythm Common Chorus

Offset Address	Description	
00 00	0000 aaaa	Chorus Type (0 - 3)
00 01	0aaa aaaa	Chorus Level (0 - 127)
00 02	0000 00aa	Chorus Output Assign (0 - 3)
00 03	0000 00aa	Chorus Output Select (0 - 2) MAIN, REV, MAIN+REV
# 00 04	0000 aaaa 0000 bbbb 0000 cccc 0000 dddd	Chorus Parameter 1 (12768 - 52768) -20000 - +20000
# 00 08	0000 aaaa 0000 bbbb 0000 cccc 0000 dddd	Chorus Parameter 2 (12768 - 52768) -20000 - +20000
# 00 0C	0000 aaaa 0000 bbbb 0000 cccc 0000 dddd	Chorus Parameter 3 (12768 - 52768) -20000 - +20000
# 00 10	0000 aaaa 0000 bbbb 0000 cccc 0000 dddd	Chorus Parameter 4 (12768 - 52768) -20000 - +20000
# 00 14	0000 aaaa 0000 bbbb 0000 cccc 0000 dddd	Chorus Parameter 5 (12768 - 52768) -20000 - +20000
# 00 18	0000 aaaa 0000 bbbb 0000 cccc 0000 dddd	Chorus Parameter 6 (12768 - 52768) -20000 - +20000
# 00 1C	0000 aaaa 0000 bbbb 0000 cccc 0000 dddd	Chorus Parameter 7 (12768 - 52768) -20000 - +20000

#	00 20	0000 aaaa 0000 bbbb 0000 cccc 0000 dddd	Chorus Parameter 8	(12768 - 52768) -20000 - +20000
#	00 24	0000 aaaa 0000 bbbb 0000 cccc 0000 dddd	Chorus Parameter 9	(12768 - 52768) -20000 - +20000
#	00 28	0000 aaaa 0000 bbbb 0000 cccc 0000 dddd	Chorus Parameter 10	(12768 - 52768) -20000 - +20000
#	00 2C	0000 aaaa 0000 bbbb 0000 cccc 0000 dddd	Chorus Parameter 11	(12768 - 52768) -20000 - +20000
#	00 30	0000 aaaa 0000 bbbb 0000 cccc 0000 dddd	Chorus Parameter 12	(12768 - 52768) -20000 - +20000
#	00 34	0000 aaaa 0000 bbbb 0000 cccc 0000 dddd	Chorus Parameter 13	(12768 - 52768) -20000 - +20000
#	00 38	0000 aaaa 0000 bbbb 0000 cccc 0000 dddd	Chorus Parameter 14	(12768 - 52768) -20000 - +20000
#	00 3C	0000 aaaa 0000 bbbb 0000 cccc 0000 dddd	Chorus Parameter 15	(12768 - 52768) -20000 - +20000
#	00 40	0000 aaaa 0000 bbbb 0000 cccc 0000 dddd	Chorus Parameter 16	(12768 - 52768) -20000 - +20000
#	00 44	0000 aaaa 0000 bbbb 0000 cccc 0000 dddd	Chorus Parameter 17	(12768 - 52768) -20000 - +20000
#	00 48	0000 aaaa 0000 bbbb 0000 cccc 0000 dddd	Chorus Parameter 18	(12768 - 52768) -20000 - +20000
#	00 4C	0000 aaaa 0000 bbbb 0000 cccc 0000 dddd	Chorus Parameter 19	(12768 - 52768) -20000 - +20000
#	00 50	0000 aaaa 0000 bbbb 0000 cccc 0000 dddd	Chorus Parameter 20	(12768 - 52768) -20000 - +20000
00 00 00 54		Total Size		

○Rhythm Common Reverb

Offset Address	Description	
00 00	0000 aaaa	Reverb Type (0 - 5)
00 01	aaaa aaaa	Reverb Level (0 - 127)
00 02	0000 00aa	Reverb Output Assign (0 - 3) A, B, ---, ---
# 00 03	0000 aaaa 0000 bbbb 0000 cccc 0000 dddd	Reverb Parameter 1 (12768 - 52768) -20000 - +20000
# 00 07	0000 aaaa 0000 bbbb 0000 cccc 0000 dddd	Reverb Parameter 2 (12768 - 52768) -20000 - +20000
# 00 0B	0000 aaaa 0000 bbbb 0000 cccc 0000 dddd	Reverb Parameter 3 (12768 - 52768) -20000 - +20000
# 00 0F	0000 aaaa 0000 bbbb 0000 cccc 0000 dddd	Reverb Parameter 4 (12768 - 52768) -20000 - +20000
# 00 13	0000 aaaa 0000 bbbb 0000 cccc 0000 dddd	Reverb Parameter 5 (12768 - 52768) -20000 - +20000
# 00 17	0000 aaaa 0000 bbbb 0000 cccc 0000 dddd	Reverb Parameter 6 (12768 - 52768) -20000 - +20000
# 00 1B	0000 aaaa 0000 bbbb 0000 cccc 0000 dddd	Reverb Parameter 7 (12768 - 52768) -20000 - +20000
# 00 1F	0000 aaaa 0000 bbbb 0000 cccc 0000 dddd	Reverb Parameter 8 (12768 - 52768) -20000 - +20000
# 00 23	0000 aaaa 0000 bbbb 0000 cccc 0000 dddd	Reverb Parameter 9 (12768 - 52768) -20000 - +20000
# 00 27	0000 aaaa 0000 bbbb 0000 cccc 0000 dddd	Reverb Parameter 10 (12768 - 52768) -20000 - +20000
# 00 2B	0000 aaaa 0000 bbbb 0000 cccc 0000 dddd	Reverb Parameter 11 (12768 - 52768) -20000 - +20000
# 00 2F	0000 aaaa 0000 bbbb 0000 cccc	

#	00 33	0000 dddd	Reverb Parameter 12	(12768 - 52768) -20000 - +20000
		0000 aaaa		
		0000 bbbb		
		0000 cccc		
		0000 dddd		
#	00 37	0000 aaaa	Reverb Parameter 13	(12768 - 52768) -20000 - +20000
		0000 bbbb		
		0000 cccc		
		0000 dddd		
#	00 3B	0000 aaaa	Reverb Parameter 14	(12768 - 52768) -20000 - +20000
		0000 bbbb		
		0000 cccc		
		0000 dddd		
#	00 3F	0000 aaaa	Reverb Parameter 15	(12768 - 52768) -20000 - +20000
		0000 bbbb		
		0000 cccc		
		0000 dddd		
#	00 43	0000 aaaa	Reverb Parameter 16	(12768 - 52768) -20000 - +20000
		0000 bbbb		
		0000 cccc		
		0000 dddd		
#	00 47	0000 aaaa	Reverb Parameter 17	(12768 - 52768) -20000 - +20000
		0000 bbbb		
		0000 cccc		
		0000 dddd		
#	00 4B	0000 aaaa	Reverb Parameter 18	(12768 - 52768) -20000 - +20000
		0000 bbbb		
		0000 cccc		
		0000 dddd		
#	00 4F	0000 aaaa	Reverb Parameter 19	(12768 - 52768) -20000 - +20000
		0000 bbbb		
		0000 cccc		
		0000 dddd		
	00 00 53	Total Size		

○Rhythm Tone

Offset Address	Description		
00 00	0aaa aaaa	Tone Name 1 (32 - 127)	
00 01	0aaa aaaa	Tone Name 2 (32 - 127) [ASCII]	
00 02	0aaa aaaa	Tone Name 3 (32 - 127) [ASCII]	
00 03	0aaa aaaa	Tone Name 4 (32 - 127) [ASCII]	
00 04	0aaa aaaa	Tone Name 5 (32 - 127) [ASCII]	
00 05	0aaa aaaa	Tone Name 6 (32 - 127) [ASCII]	
00 06	0aaa aaaa	Tone Name 7 (32 - 127) [ASCII]	
00 07	0aaa aaaa	Tone Name 8 (32 - 127) [ASCII]	
00 08	0aaa aaaa	Tone Name 9 (32 - 127) [ASCII]	
00 09	0aaa aaaa	Tone Name 10 (32 - 127) [ASCII]	
00 0A	0aaa aaaa	Tone Name 11 (32 - 127) [ASCII]	
00 0B	0aaa aaaa	Tone Name 12 (32 - 127) [ASCII]	
00 0C	0000 000a	Assign Type (0 - 1) MULTI, SINGLE	
00 0D	000a aaaa	Mute Group (0 - 31) OFF, 1 - 31	
00 0E	0aaa aaaa	Tone Level (0 - 127)	
00 0F	0aaa aaaa	Tone Coarse Tune (0 - 127)	
00 10	0aaa aaaa	Tone Fine Tune (C-1 - G9) (14 - 114)	
00 11	000a aaaa	Tone Random Pitch Depth (0 - 30) 0, 1, 2, 3, 4, 5, 6, 7, 8, 9, 10, 20, 30, 40, 50, 60, 70, 80, 90, 100, 200, 300, 400, 500, 600, 700, 800, 900, 1000, 1100,	
00 12	0aaa aaaa	Tone Pan (0 - 127) L64 - 63R	
00 13	00aa aaaa	Tone Random Pan Depth (0 - 63)	
00 14	0aaa aaaa	Tone Alternate Pan Depth (1 - 127) L63 - 63R	
00 15	0000 000a	Tone Env Mode (0 - 1) NO-SUS, SUSTAIN	
00 16	0aaa aaaa	Tone Dry Send Level (0 - 127)	
00 17	0aaa aaaa	Tone Chorus Send Level (0 - 127)	
00 18	0aaa aaaa	Tone Reverb Send Level (0 - 127)	
00 19	0aaa aaaa	Tone Chorus Send Level (non MPX) (0 - 127)	
00 1A	0aaa aaaa	Tone Reverb Send Level (non MPX) (0 - 127)	
00 1B	0000 aaaa	Tone Output Assign (0 - 12) MPX, A, B, ---, ---, 1, 2, 3, 4, ---, ---, ---, ---	
00 1C	00aa aaaa	Tone Pitch Bend Range (0 - 48)	
00 1D	0000 000a	Tone Receive Expression (0 - 1) OFF, ON	
00 1E	0000 000a	Tone Receive Hold-1 (0 - 1) OFF, ON	
00 1F	0000 000a	Tone Receive Pan Mode (0 - 1) CONTINUOUS, KEY-ON	
00 20	0000 00aa	WMT Velocity Control (0 - 2) OFF, ON, RANDOM	
00 21	0000 000a	WMT1 Wave Switch (0 - 1) OFF, ON	
00 22	0000 00aa	WMT1 Wave Group Type (0 - 3) INT, SRX, SAMPLE, MULTISAMPLE	
#	00 23	0000 aaaa 0000 bbbb 0000 cccc 0000 dddd	WMT1 Wave Group ID (0 - 16384) OFF, 1 - 16384
#	00 27	0000 aaaa 0000 bbbb 0000 cccc 0000 dddd	WMT1 Wave Number L (Mono) (0 - 16384) OFF, 1 - 16384
#	00 2B	0000 aaaa 0000 bbbb 0000 cccc	WMT1 Wave Number R (0 - 16384) OFF, 1 - 16384

	00 2F	0000 00aa	WMT1 Wave Gain	(0 - 16384) OFF, 1 - 16384
		0000 000a	WMT1 Wave FXM Switch	(0 - 1) OFF, ON
	00 30	0000 00aa	WMT1 Wave FXM Color	-6, 0, +6, +12 [dB] (0 - 3)
	00 31	0000 00aa	WMT1 Wave FXM Depth	(0 - 16) 1 - 4
	00 32	000a aaaa	WMT1 Wave Tempo Sync	(0 - 16) (0 - 1)
	00 33	0000 000a	WMT1 Wave Coarse Tune	(16 - 112) OFF, ON
	00 34	0aaa aaaa	WMT1 Wave Fine Tune	(16 - 112) -48 - +48
	00 35	0aaa aaaa	WMT1 Wave Pan	(14 - 114) -50 - +50
	00 36	0aaa aaaa	WMT1 Wave Random Pan Switch	(0 - 127) L64 - 63R
	00 37	0000 000a	WMT1 Wave Alternate Pan Switch	(0 - 1) OFF, ON
	00 38	0000 00aa	WMT1 Wave Level	(0 - 2) OFF, ON, REVERSE
	00 39	0aaa aaaa	WMT1 Velocity Range Lower	(0 - 127) (1 - 127)
	00 3A	0aaa aaaa	WMT1 Velocity Range Upper	1 - UPPER (1 - 127)
	00 3B	0aaa aaaa	WMT1 Velocity Fade Width Lower	LOWER - 127 (0 - 127)
	00 3C	0aaa aaaa	WMT1 Velocity Fade Width Upper	(0 - 127) (0 - 1)
	00 3D	0000 000a	WMT2 Wave Switch	(0 - 1) OFF, ON
	00 3E	0000 00aa	WMT2 Wave Group Type	(0 - 3) INT, SRX, SAMPLE, MULTISAMPLE
#	00 40	0000 aaaa 0000 bbbb 0000 cccc 0000 dddd	WMT2 Wave Group ID	(0 - 16384) OFF, 1 - 16384
#	00 44	0000 aaaa 0000 bbbb 0000 cccc 0000 dddd	WMT2 Wave Number L (Mono)	(0 - 16384) OFF, 1 - 16384
#	00 48	0000 aaaa 0000 bbbb 0000 cccc 0000 dddd	WMT2 Wave Number R	(0 - 16384) OFF, 1 - 16384
	00 4C	0000 00aa	WMT2 Wave Gain	(0 - 16384) OFF, 1 - 16384
	00 4D	0000 000a	WMT2 Wave FXM Switch	(0 - 3) -6, 0, +6, +12 [dB] OFF, ON
	00 4E	0000 00aa	WMT2 Wave FXM Color	(0 - 3) 1 - 4
	00 4F	000a aaaa	WMT2 Wave FXM Depth	(0 - 16) 1 - 4
	00 50	0000 000a	WMT2 Wave Tempo Sync	(0 - 1) OFF, ON
	00 51	0aaa aaaa	WMT2 Wave Coarse Tune	(16 - 112) OFF, ON
	00 52	0aaa aaaa	WMT2 Wave Fine Tune	(16 - 114) -48 - +48
	00 53	0aaa aaaa	WMT2 Wave Pan	(14 - 114) -50 - +50
	00 54	0000 000a	WMT2 Wave Random Pan Switch	(0 - 127) L64 - 63R
	00 55	0000 00aa	WMT2 Wave Alternate Pan Switch	(0 - 1) OFF, ON
	00 56	0aaa aaaa	WMT2 Wave Level	(0 - 2) OFF, ON, REVERSE
	00 57	0aaa aaaa	WMT2 Velocity Range Lower	(0 - 127) (1 - 127)
	00 58	0aaa aaaa	WMT2 Velocity Range Upper	1 - UPPER (1 - 127)
	00 59	0aaa aaaa	WMT2 Velocity Fade Width Lower	LOWER - 127 (0 - 127)
	00 5A	0aaa aaaa	WMT2 Velocity Fade Width Upper	(0 - 127) (0 - 1)
	00 5B	0000 000a	WMT3 Wave Switch	(0 - 1) OFF, ON
	00 5C	0000 00aa	WMT3 Wave Group Type	(0 - 3) INT, SRX, SAMPLE, MULTISAMPLE
#	00 5D	0000 aaaa 0000 bbbb 0000 cccc 0000 dddd	WMT3 Wave Group ID	(0 - 16384) OFF, 1 - 16384
#	00 61	0000 aaaa 0000 bbbb 0000 cccc 0000 dddd	WMT3 Wave Number L (Mono)	(0 - 16384) OFF, 1 - 16384
#	00 65	0000 aaaa 0000 bbbb 0000 cccc 0000 dddd	WMT3 Wave Number R	(0 - 16384) OFF, 1 - 16384
	00 69	0000 00aa	WMT3 Wave Gain	(0 - 16384) OFF, 1 - 16384
	00 6A	0000 000a	WMT3 Wave FXM Switch	(0 - 3) -6, 0, +6, +12 [dB] OFF, ON
	00 6B	0000 00aa	WMT3 Wave FXM Color	(0 - 3) 1 - 4
	00 6C	000a aaaa	WMT3 Wave FXM Depth	(0 - 16) 1 - 4
	00 6D	0000 000a	WMT3 Wave Tempo Sync	(0 - 1) OFF, ON
	00 6E	0aaa aaaa	WMT3 Wave Coarse Tune	(16 - 112) OFF, ON
	00 6F	0aaa aaaa	WMT3 Wave Fine Tune	(16 - 114) -48 - +48
	00 70	0aaa aaaa	WMT3 Wave Pan	(14 - 114) -50 - +50
	00 71	0000 000a	WMT3 Wave Random Pan Switch	(0 - 127) L64 - 63R
	00 72	0000 00aa	WMT3 Wave Alternate Pan Switch	(0 - 1) OFF, ON
	00 73	0aaa aaaa	WMT3 Wave Level	(0 - 2) OFF, ON, REVERSE
	00 74	0aaa aaaa	WMT3 Velocity Range Lower	(0 - 127) (1 - 127)
	00 75	0aaa aaaa	WMT3 Velocity Range Upper	1 - UPPER (1 - 127)
	00 76	0aaa aaaa	WMT3 Velocity Fade Width Lower	LOWER - 127 (0 - 127)
	00 77	0aaa aaaa	WMT3 Velocity Fade Width Upper	(0 - 127) (0 - 1)
	00 78	0000 000a	WMT4 Wave Switch	(0 - 1) OFF, ON
	00 79	0000 00aa	WMT4 Wave Group Type	(0 - 3) INT, SRX, SAMPLE, MULTISAMPLE
#	00 7A	0000 aaaa 0000 bbbb 0000 cccc 0000 dddd	WMT4 Wave Group ID	(0 - 16384) OFF, 1 - 16384
#	00 7E	0000 aaaa 0000 bbbb 0000 cccc 0000 dddd	WMT4 Wave Number L (Mono)	(0 - 16384) OFF, 1 - 16384
#	01 02	0000 aaaa 0000 bbbb 0000 cccc 0000 dddd	WMT4 Wave Number R	(0 - 16384) OFF, 1 - 16384
	01 06	0000 00aa	WMT4 Wave Gain	(0 - 16384) OFF, 1 - 16384

MIDI Implementation

01 07	0000 000a	WMT4 Wave FXM Switch	-6, 0, +6, +12 [dB] (0 - 1) OFF, ON
01 08	0000 00aa	WMT4 Wave FXM Color	(0 - 3) 1 - 4
01 09	000a aaaa	WMT4 Wave FXM Depth	(0 - 16)
01 0A	0000 000a	WMT4 Wave Tempo Sync	(0 - 1) OFF, ON
01 0B	0aaa aaaa	WMT4 Wave Coarse Tune	(16 - 112) -48 - +48
01 0C	0aaa aaaa	WMT4 Wave Fine Tune	(14 - 114) -50 - +50
01 0D	0aaa aaaa	WMT4 Wave Pan	(0 - 127) L64 - 63R
01 0E	0000 000a	WMT4 Wave Random Pan Switch	(0 - 1) OFF, ON
01 0F	0000 00aa	WMT4 Wave Alternate Pan Switch	(0 - 2) OFF, ON, REVERSE
01 10	0aaa aaaa	WMT4 Wave Level	(0 - 127)
01 11	0aaa aaaa	WMT4 Velocity Range Lower	(1 - 127) 1 - UPPER
01 12	0aaa aaaa	WMT4 Velocity Range Upper	(1 - 127) LOWER - 127
01 13	0aaa aaaa	WMT4 Velocity Fade Width Lower	(0 - 127)
01 14	0aaa aaaa	WMT4 Velocity Fade Width Upper	(0 - 127)
01 15	000a aaaa	Pitch Env Depth	(52 - 76) -12 - +12
01 16	0aaa aaaa	Pitch Env Velocity Sens	(1 - 127)
01 17	0aaa aaaa	Pitch Env Time 1 Velocity Sens	-63 - +63 (1 - 127)
01 18	0aaa aaaa	Pitch Env Time 4 Velocity Sens	-63 - +63 (1 - 127)
01 19	0aaa aaaa	Pitch Env Time 1	(0 - 127)
01 1A	0aaa aaaa	Pitch Env Time 2	(0 - 127)
01 1B	0aaa aaaa	Pitch Env Time 3	(0 - 127)
01 1C	0aaa aaaa	Pitch Env Time 4	(0 - 127)
01 1D	0aaa aaaa	Pitch Env Level 0	(1 - 127)
01 1E	0aaa aaaa	Pitch Env Level 1	-63 - +63 (1 - 127)
01 1F	0aaa aaaa	Pitch Env Level 2	-63 - +63 (1 - 127)
01 20	0aaa aaaa	Pitch Env Level 3	-63 - +63 (1 - 127)
01 21	0aaa aaaa	Pitch Env Level 4	-63 - +63 (1 - 127)
01 22	0000 0aaa	TVF Filter Type	(0 - 6) OFF, LPF, BPF, HPF, PKG, LPP2, LPP3
01 23	0aaa aaaa	TVF Cutoff Frequency	(0 - 127)
01 24	0000 0aaa	TVF Cutoff Velocity Curve	(0 - 7) FIXED, 1 - 7
01 25	0aaa aaaa	TVF Cutoff Velocity Sens	(1 - 127) -63 - +63
01 26	0aaa aaaa	TVF Resonance	(0 - 127)
01 27	0aaa aaaa	TVF Resonance Velocity Sens	(1 - 127) -63 - +63
01 28	0aaa aaaa	TVF Env Depth	(1 - 127) -63 - +63
01 29	0000 0aaa	TVF Env Velocity Curve Type	(0 - 7) FIXED, 1 - 7
01 2A	0aaa aaaa	TVF Env Velocity Sens	(1 - 127) -63 - +63
01 2B	0aaa aaaa	TVF Env Time 1 Velocity Sens	(1 - 127) -63 - +63
01 2C	0aaa aaaa	TVF Env Time 4 Velocity Sens	(1 - 127) -63 - +63
01 2D	0aaa aaaa	TVF Env Time 1	(0 - 127)
01 2E	0aaa aaaa	TVF Env Time 2	(0 - 127)
01 2F	0aaa aaaa	TVF Env Time 3	(0 - 127)
01 30	0aaa aaaa	TVF Env Time 4	(0 - 127)
01 31	0aaa aaaa	TVF Env Level 0	(0 - 127)
01 32	0aaa aaaa	TVF Env Level 1	(0 - 127)
01 33	0aaa aaaa	TVF Env Level 2	(0 - 127)
01 34	0aaa aaaa	TVF Env Level 3	(0 - 127)
01 35	0aaa aaaa	TVF Env Level 4	(0 - 127)
01 36	0000 0aaa	TVA Level Velocity Curve	(0 - 7) FIXED, 1 - 7
01 37	0aaa aaaa	TVA Level Velocity Sens	(1 - 127) -63 - +63
01 38	0aaa aaaa	TVA Env Time 1 Velocity Sens	(1 - 127) -63 - +63
01 39	0aaa aaaa	TVA Env Time 4 Velocity Sens	(1 - 127) -63 - +63
01 3A	0aaa aaaa	TVA Env Time 1	(0 - 127)
01 3B	0aaa aaaa	TVA Env Time 2	(0 - 127)
01 3C	0aaa aaaa	TVA Env Time 3	(0 - 127)
01 3D	0aaa aaaa	TVA Env Time 4	(0 - 127)
01 3E	0aaa aaaa	TVA Env Level 1	(0 - 127)
01 3F	0aaa aaaa	TVA Env Level 2	(0 - 127)
01 40	0aaa aaaa	TVA Env Level 3	(0 - 127)
01 41	0000 000a	One Shot Mode	(0 - 1) OFF, ON
01 42	0aaa aaaa	Aftertouch Time Ctrl Sens	(1 - 127) -63 - +63
00 00 01 43	Total Size		

2. GS (Model ID = 42H)

System Parameter

Start Address	Description	
# 40 00 00	0000 aaaa 0000 bbbb 0000 cccc 0000 dddd	Master Tune (24 - 2024)
40 00 04	0aaa aaaa	Master Volume (0 - 127)
40 00 05	0aaa aaaa	Master Key Shift (40 - 89)
40 00 06	0aaa aaaa	Master Pan (-24 - +24 [semitone]) (1 - 127) L63 - 63R
40 00 7F	0aaa aaaa	Mode Set (0 - 127) GS-RESET, GS-EXIT

Common Parameter

Start Address	Description	
40 01 10	0aaa aaaa	Voice Reserve 1 (0 - 24)
40 01 11	0aaa aaaa	Voice Reserve 2 (0 - 24)

40 01 12	0aaa aaaa	Voice Reserve 3 (0 - 24)
40 01 13	0aaa aaaa	Voice Reserve 4 (0 - 24)
40 01 14	0aaa aaaa	Voice Reserve 5 (0 - 24)
40 01 15	0aaa aaaa	Voice Reserve 6 (0 - 24)
40 01 16	0aaa aaaa	Voice Reserve 7 (0 - 24)
40 01 17	0aaa aaaa	Voice Reserve 8 (0 - 24)
40 01 18	0aaa aaaa	Voice Reserve 9 (0 - 24)
40 01 19	0aaa aaaa	Voice Reserve 10 (0 - 24)
40 01 1A	0aaa aaaa	Voice Reserve 11 (0 - 24)
40 01 1B	0aaa aaaa	Voice Reserve 12 (0 - 24)
40 01 1C	0aaa aaaa	Voice Reserve 13 (0 - 24)
40 01 1D	0aaa aaaa	Voice Reserve 14 (0 - 24)
40 01 1E	0aaa aaaa	Voice Reserve 15 (0 - 24)
40 01 1F	0aaa aaaa	Voice Reserve 16 (0 - 24)
40 01 30	0aaa aaaa	Reverb Macro (0 - 7)
40 01 31	0aaa aaaa	Reverb Character (0 - 7)
40 01 32	0aaa aaaa	Reverb Pre-LPF (0 - 7)
40 01 33	0aaa aaaa	Reverb Level (0 - 127)
40 01 34	0aaa aaaa	Reverb Time (0 - 127)
40 01 35	0aaa aaaa	Reverb Delay Feedback (0 - 127)
40 01 36	0aaa aaaa	Reverb Send Level to Chorus<*> (0 - 127)
40 01 38	0aaa aaaa	Chorus Macro (0 - 7)
40 01 39	0aaa aaaa	Chorus Pre-LPF (0 - 7)
40 01 3A	0aaa aaaa	Chorus Level (0 - 127)
40 01 3B	0aaa aaaa	Chorus Feedback (0 - 127)
40 01 3C	0aaa aaaa	Chorus Delay (0 - 127)
40 01 3D	0aaa aaaa	Chorus Rate (0 - 127)
40 01 3E	0aaa aaaa	Chorus Depth (0 - 127)
40 01 3F	0aaa aaaa	Chorus Send Level to Reverb (0 - 127)

Part Parameter

Start Address	Description	
# 40 1x 00	0aaa aaaa 0aaa aaaa	Tone Number CC#00 Value (0 - 127) Tone Number PC Value (0 - 127)
40 1x 02	0aaa aaaa	Rx. Channel (0 - 16) 1 - 16, OFF
40 1x 03	0000 000a	Rx. Pitch Bend (0 - 1) OFF, ON
40 1x 04	0000 000a	Rx. Channel Pressure (0 - 1) OFF, ON
40 1x 05	0000 000a	Rx. Program Change (0 - 1) OFF, ON
40 1x 06	0000 000a	Rx. Control Change (0 - 1) OFF, ON
40 1x 07	0000 000a	Rx. Poly Pressure (0 - 1) OFF, ON
40 1x 08	0000 000a	Rx. Note Message (0 - 1) OFF, ON
40 1x 09	0000 000a	Rx. RPN (0 - 1) OFF, ON
40 1x 0A	0000 000a	Rx. NRPN (0 - 1) OFF, ON
40 1x 0B	0000 000a	Rx. Modulation (0 - 1) OFF, ON
40 1x 0C	0000 000a	Rx. Volume (0 - 1) OFF, ON
40 1x 0D	0000 000a	Rx. Panpot (0 - 1) OFF, ON
40 1x 0E	0000 000a	Rx. Expression (0 - 1) OFF, ON
40 1x 0F	0000 000a	Rx. Hold-1 (0 - 1) OFF, ON
40 1x 10	0000 000a	Rx. Portamento (0 - 1) OFF, ON
40 1x 11	0000 000a	Rx. Sostenuo (0 - 1) OFF, ON
40 1x 12	0000 000a	Rx. Soft (0 - 1) OFF, ON
40 1x 13	0aaa aaaa	Mono / Poly Mode (0 - 1) MODE, POLY
40 1x 14	0aaa aaaa	Assign Mode<*> (0 - 2) MODE, POLY
40 1x 15	0aaa aaaa	Use for Rhythm Part (0 - 2) SINGLE, LIMITED-MULTI, FULL-MULTI
40 1x 16	0aaa aaaa	Pitch Key Shift (-24 - +24 [semitone]) (40 - 88)
# 40 1x 17	0000 aaaa 0000 bbbb	Pitch Offset Fine (8 - 248) -12.0 - +12.0 [Hz]
40 1x 19	0aaa aaaa	Part Level (CC# 7) (0 - 127)
40 1x 1A	0aaa aaaa	Velocity Sens Depth (0 - 127) -64 - +63
40 1x 1B	0aaa aaaa	Velocity Sens Offset (0 - 127) -64 - +63
40 1x 1C	0aaa aaaa	Part Panpot (CC# 10) (0 - 127) RANDOM, L63 - 63R
40 1x 1D	0aaa aaaa	Keyboard Range Low (0 - 127)
40 1x 1E	0aaa aaaa	Keyboard Range High (0 - 127)
40 1x 1F	0aaa aaaa	CC1 Controller Number (0 - 95)
40 1x 20	0aaa aaaa	CC2 Controller Number (0 - 95)
40 1x 21	0aaa aaaa	Chorus Send Level (CC# 93) (0 - 127)
40 1x 22	0aaa aaaa	Reverb Send Level (CC# 93) (0 - 127)
40 1x 23	0000 000a	Rx. Bank Select<*> (0 - 1) OFF, ON
40 1x 24	0000 000a	Rx. Bank Select LSB<*> (0 - 1) OFF, ON
40 1x 30	0aaa aaaa	Tone Modify 1 (Vibrato Rate) (-64 - +63) (0 - 127)
40 1x 31	0aaa aaaa	Tone Modify 2 (Vibrato Depth) (-64 - +63) (0 - 127)
40 1x 32	0aaa aaaa	Tone Modify 3 (TVF Cutoff Freq.) (-64 - +63) (0 - 127)
40 1x 33	0aaa aaaa	Tone Modify 4 (TVF Resonance) (-64 - +63) (0 - 127)
40 1x 34	0aaa aaaa	Tone Modify 5 (TVF&TVA Env. Attack) (-64 - +63) (0 - 127)
40 1x 35	0aaa aaaa	Tone Modify 6 (TVF&TVA Env. Decay) (-64 - +63) (0 - 127)
40 1x 36	0aaa aaaa	Tone Modify 7 (TVF&TVA Env. Release) (-64 - +63) (0 - 127)
40 1x 37	0aaa aaaa	Tone Modify 8 (Vibrato Delay) (-64 - +63) (0 - 127)
40 1x 40	0aaa aaaa	Scale Tuning C (-64 - +63 [cent]) (0 - 127)
40 1x 41	0aaa aaaa	Scale Tuning C# (-64 - +63 [cent]) (0 - 127)
40 1x 42	0aaa aaaa	Scale Tuning D (-64 - +63 [cent]) (0 - 127)
40 1x 43	0aaa aaaa	Scale Tuning D# (-64 - +63 [cent]) (0 - 127)
40 1x 44	0aaa aaaa	Scale Tuning E (-64 - +63 [cent]) (0 - 127)
40 1x 45	0aaa aaaa	Scale Tuning F (-64 - +63 [cent]) (0 - 127)
40 1x 46	0aaa aaaa	Scale Tuning F# (-64 - +63 [cent]) (0 - 127)

MIDI Implementation

40 1x 47	0aaa aaaa	Scale Tuning G	-64 - +63 [cent] (0 - 127)
40 1x 48	0aaa aaaa	Scale Tuning G#	-64 - +63 [cent] (0 - 127)
40 1x 49	0aaa aaaa	Scale Tuning A	-64 - +63 [cent] (0 - 127)
40 1x 4A	0aaa aaaa	Scale Tuning A#	-64 - +63 [cent] (0 - 127)
40 1x 4B	0aaa aaaa	Scale Tuning B	-64 - +63 [cent] (0 - 127)
40 2x 00	0aaa aaaa	Mod Pitch Control	(40 - 88) -24 - +24 [semitone]
40 2x 01	0aaa aaaa	Mod TVF Cutoff Control	(0 - 127) -9600 - +9600 [cent]
40 2x 02	0aaa aaaa	Mod Amplitude Control	(0 - 127) -100.0 - +100.0 [%]
40 2x 03	0aaa aaaa	Mod LFO1 Rate Control	(0 - 127) -10.0 - +10.0 [Hz]
40 2x 04	0aaa aaaa	Mod LFO1 Pitch Control	(0 - 127) 0 - 600 [cent]
40 2x 05	0aaa aaaa	Mod LFO1 TVF Depth	(0 - 127) 0 - 2400 [cent]
40 2x 06	0aaa aaaa	Mod LFO1 TVA Depth	(0 - 127) 0 - 100.0 [%]
40 2x 07	0aaa aaaa	Mod LFO2 Rate Control	(0 - 127) -10.0 - +10.0 [Hz]
40 2x 08	0aaa aaaa	Mod LFO2 Pitch Control	(0 - 127) 0 - 600 [cent]
40 2x 09	0aaa aaaa	Mod LFO2 TVF Depth	(0 - 127) 0 - 2400 [cent]
40 2x 0A	0aaa aaaa	Mod LFO2 TVA Depth	(0 - 127) 0 - 100.0 [%]
40 2x 10	0aaa aaaa	Bend Pitch Control	(64 - 88) 0 - 24 [semitone]
40 2x 11	0aaa aaaa	Bend TVF Cutoff Control	(0 - 127) -9600 - +9600 [cent]
40 2x 12	0aaa aaaa	Bend Amplitude Control	(0 - 127) -100.0 - +100.0 [%]
40 2x 13	0aaa aaaa	Bend LFO1 Rate Control	(0 - 127) -10.0 - +10.0 [Hz]
40 2x 14	0aaa aaaa	Bend LFO1 Pitch Control	(0 - 127) 0 - 600 [cent]
40 2x 15	0aaa aaaa	Bend LFO1 TVF Depth	(0 - 127) 0 - 2400 [cent]
40 2x 16	0aaa aaaa	Bend LFO1 TVA Depth	(0 - 127) 0 - 100.0 [%]
40 2x 17	0aaa aaaa	Bend LFO2 Rate Control	(0 - 127) -10.0 - +10.0 [Hz]
40 2x 18	0aaa aaaa	Bend LFO2 Pitch Control	(0 - 127) 0 - 600 [cent]
40 2x 19	0aaa aaaa	Bend LFO2 TVF Depth	(0 - 127) 0 - 2400 [cent]
40 2x 1A	0aaa aaaa	Bend LFO2 TVA Depth	(0 - 127) 0 - 100.0 [%]
40 2x 20	0aaa aaaa	CAf Pitch Control	(40 - 88) -24 - +24 [semitone]
40 2x 21	0aaa aaaa	CAf TVF Cutoff Control	(0 - 127) -9600 - +9600 [cent]
40 2x 22	0aaa aaaa	CAf Amplitude Control	(0 - 127) -100.0 - +100.0 [%]
40 2x 23	0aaa aaaa	CAf LFO1 Rate Control	(0 - 127) -10.0 - +10.0 [Hz]
40 2x 24	0aaa aaaa	CAf LFO1 Pitch Control	(0 - 127) 0 - 600 [cent]
40 2x 25	0aaa aaaa	CAf LFO1 TVF Depth	(0 - 127) 0 - 2400 [cent]
40 2x 26	0aaa aaaa	CAf LFO1 TVA Depth	(0 - 127) 0 - 100.0 [%]
40 2x 27	0aaa aaaa	CAf LFO2 Rate Control	(0 - 127) -10.0 - +10.0 [Hz]
40 2x 28	0aaa aaaa	CAf LFO2 Pitch Control	(0 - 127) 0 - 600 [cent]
40 2x 29	0aaa aaaa	CAf LFO2 TVF Depth	(0 - 127) 0 - 2400 [cent]
40 2x 2A	0aaa aaaa	CAf LFO2 TVA Depth	(0 - 127) 0 - 100.0 [%]
40 2x 30	0aaa aaaa	PAf Pitch Control	(40 - 88) -24 - +24 [semitone]
40 2x 31	0aaa aaaa	PAf TVF Cutoff Control	(0 - 127) -9600 - +9600 [cent]
40 2x 32	0aaa aaaa	PAf Amplitude Control	(0 - 127) -100.0 - +100.0 [%]
40 2x 33	0aaa aaaa	PAf LFO1 Rate Control	(0 - 127) -10.0 - +10.0 [Hz]
40 2x 34	0aaa aaaa	PAf LFO1 Pitch Control	(0 - 127) 0 - 600 [cent]
40 2x 35	0aaa aaaa	PAf LFO1 TVF Depth	(0 - 127) 0 - 2400 [cent]
40 2x 36	0aaa aaaa	PAf LFO1 TVA Depth	(0 - 127) 0 - 100.0 [%]
40 2x 37	0aaa aaaa	PAf LFO2 Rate Control	(0 - 127) -10.0 - +10.0 [Hz]
40 2x 38	0aaa aaaa	PAf LFO2 Pitch Control	(0 - 127) 0 - 600 [cent]
40 2x 39	0aaa aaaa	PAf LFO2 TVF Depth	(0 - 127) 0 - 2400 [cent]
40 2x 3A	0aaa aaaa	PAf LFO2 TVA Depth	(0 - 127) 0 - 100.0 [%]
40 2x 40	0aaa aaaa	CC1 Pitch Control	(40 - 88) -24 - +24 [semitone]
40 2x 41	0aaa aaaa	CC1 TVF Cutoff Control	(0 - 127) -9600 - +9600 [cent]
40 2x 42	0aaa aaaa	CC1 Amplitude Control	(0 - 127) -100.0 - +100.0 [%]
40 2x 43	0aaa aaaa	CC1 LFO1 Rate Control	(0 - 127) -10.0 - +10.0 [Hz]
40 2x 44	0aaa aaaa	CC1 LFO1 Pitch Control	(0 - 127) 0 - 600 [cent]
40 2x 45	0aaa aaaa	CC1 LFO1 TVF Depth	(0 - 127) 0 - 2400 [cent]
40 2x 46	0aaa aaaa	CC1 LFO1 TVA Depth	(0 - 127) 0 - 100.0 [%]
40 2x 47	0aaa aaaa	CC1 LFO2 Rate Control	(0 - 127) -10.0 - +10.0 [Hz]
40 2x 48	0aaa aaaa	CC1 LFO2 Pitch Control	(0 - 127) 0 - 600 [cent]
40 2x 49	0aaa aaaa	CC1 LFO2 TVF Depth	(0 - 127) 0 - 2400 [cent]
40 2x 4A	0aaa aaaa	CC1 LFO2 TVA Depth	(0 - 127) 0 - 100.0 [%]
40 2x 50	0aaa aaaa	CC2 Pitch Control	(40 - 88) -24 - +24 [semitone]
40 2x 51	0aaa aaaa	CC2 TVF Cutoff Control	(0 - 127) -9600 - +9600 [cent]
40 2x 52	0aaa aaaa	CC2 Amplitude Control	(0 - 127) -100.0 - +100.0 [%]
40 2x 53	0aaa aaaa	CC2 LFO1 Rate Control	(0 - 127) -10.0 - +10.0 [Hz]
40 2x 54	0aaa aaaa	CC2 LFO1 Pitch Control	(0 - 127) 0 - 600 [cent]
40 2x 55	0aaa aaaa	CC2 LFO1 TVF Depth	(0 - 127) 0 - 2400 [cent]

40 2x 56	0aaa aaaa	CC2 LFO1 TVA Depth	0 - 2400 [cent] (0 - 127)
40 2x 57	0aaa aaaa	CC2 LFO2 Rate Control	0 - 100.0 [%] (0 - 127)
40 2x 58	0aaa aaaa	CC2 LFO2 Pitch Control	-10.0 - +10.0 [Hz] (0 - 127)
40 2x 59	0aaa aaaa	CC2 LFO2 TVF Depth	0 - 600 [cent] (0 - 127)
40 2x 5A	0aaa aaaa	CC2 LFO2 TVA Depth	0 - 2400 [cent] (0 - 127)

x: BLOCK NUMBER (0-F)
 Part 1 (MIDI ch = 1) x = 1
 Part 2 (MIDI ch = 2) x = 2
 :
 :
 Part 9 (MIDI ch = 9) x = 9
 Part10 (MIDI ch = 10) x = 0
 Part11 (MIDI ch = 11) x = A
 Part12 (MIDI ch = 12) x = B
 :
 :
 Part16 (MIDI ch = 16) x = F

Drum Setup Parameter

Start	Address	Description	
41 m0 00	0aaa aaaa	Drum Map Name 1	(32 - 127)
41 m0 01	0aaa aaaa	Drum Map Name 2	32 - 127 [ASCII] (32 - 127)
41 m0 02	0aaa aaaa	Drum Map Name 3	32 - 127 [ASCII] (32 - 127)
41 m0 03	0aaa aaaa	Drum Map Name 4	32 - 127 [ASCII] (32 - 127)
41 m0 04	0aaa aaaa	Drum Map Name 5	32 - 127 [ASCII] (32 - 127)
41 m0 05	0aaa aaaa	Drum Map Name 6	32 - 127 [ASCII] (32 - 127)
41 m0 06	0aaa aaaa	Drum Map Name 7	32 - 127 [ASCII] (32 - 127)
41 m0 07	0aaa aaaa	Drum Map Name 8	32 - 127 [ASCII] (32 - 127)
41 m0 08	0aaa aaaa	Drum Map Name 9	32 - 127 [ASCII] (32 - 127)
41 m0 09	0aaa aaaa	Drum Map Name 10	32 - 127 [ASCII] (32 - 127)
41 m0 0A	0aaa aaaa	Drum Map Name 11	32 - 127 [ASCII] (32 - 127)
41 m0 0B	0aaa aaaa	Drum Map Name 12	32 - 127 [ASCII] (32 - 127)
41 m1 rr	0aaa aaaa	Play Note Number	(0 - 127)
41 m2 rr	0aaa aaaa	Level	(0 - 127)
41 m3 rr	0aaa aaaa	Assign Group Number	(0 - 127)
41 m4 rr	0aaa aaaa	Panpot	NON, 1 - 127 (0 - 127)
41 m5 rr	0aaa aaaa	Reverb Send Level	RANDOM, L63 - 63R (0 - 127)
41 m6 rr	0aaa aaaa	Chorus Send Level	0.0 - 1.0 (0 - 127)
41 m7 rr	0000 000a	Rx. Note Off	0.0 - 1.0 (0 - 1)
41 m8 rr	0000 000a	Rx. Note On	OFF, ON (0 - 1) OFF, ON

m: Map number (0 = MAP1, 1 = MAP2)
 rr: drum part note number (00H-7FH)

6. Supplementary Material

Decimal and Hexadecimal Table

(An "H" is appended to the end of numbers in hexadecimal notation.)
 In MIDI documentation, data values and addresses/sizes of Exclusive messages, etc. are expressed as hexadecimal values for each 7 bits.
 The following table shows how these correspond to decimal numbers.

D	H	D	H	D	H	D	H
0	00H	32	20H	64	40H	96	60H
1	01H	33	21H	65	41H	97	61H
2	02H	34	22H	66	42H	98	62H
3	03H	35	23H	67	43H	99	63H
4	04H	36	24H	68	44H	100	64H
5	05H	37	25H	69	45H	101	65H
6	06H	38	26H	70	46H	102	66H
7	07H	39	27H	71	47H	103	67H
8	08H	40	28H	72	48H	104	68H
9	09H	41	29H	73	49H	105	69H
10	0AH	42	2AH	74	4AH	106	6AH
11	0BH	43	2BH	75	4BH	107	6BH
12	0CH	44	2CH	76	4CH	108	6CH
13	0DH	45	2DH	77	4DH	109	6DH
14	0EH	46	2EH	78	4EH	110	6EH
15	0FH	47	2FH	79	4FH	111	6FH
16	10H	48	30H	80	50H	112	70H
17	11H	49	31H	81	51H	113	71H
18	12H	50	32H	82	52H	114	72H
19	13H	51	33H	83	53H	115	73H
20	14H	52	34H	84	54H	116	74H
21	15H	53	35H	85	55H	117	75H
22	16H	54	36H	86	56H	118	76H
23	17H	55	37H	87	57H	119	77H
24	18H	56	38H	88	58H	120	78H
25	19H	57	39H	89	59H	121	79H
26	1AH	58	3AH	90	5AH	122	7AH
27	1BH	59	3BH	91	5BH	123	7BH
28	1CH	60	3CH	92	5CH	124	7CH
29	1DH	61	3DH	93	5DH	125	7DH
30	1EH	62	3EH	94	5EH	126	7EH
31	1FH	63	3FH	95	5FH	127	7FH

D: decimal

H: hexadecimal

- * Decimal values such as MIDI channel, bank select, and program change are listed as one greater than the values given in the above table.
- * A 7-bit byte can express data in the range of 128 steps. For data where greater precision is required, we must use two or more bytes. For example, two hexadecimal numbers aa bbH expressing two 7-bit bytes would indicate a value of $aa \times 128 + bb$.
- * In the case of values which have a +/- sign, 00H = -64, 40H = +/-0, and 7FH = +63, so that the decimal expression would be 64 less than the value given in the above chart. In the case of two types, 00 00H = -8192, 40 00H = +/-0, and 7F 7FH = +8191. For example, if aa bbH were expressed as decimal, this would be $aa \text{ bbH} - 40 \text{ 00H} = aa \times 128 + bb - 64 \times 128$.
- * Data marked "Use nibbled data" is expressed in hexadecimal in 4-bit units. A value expressed as a 2-byte nibble 0a 0bH has the value of $a \times 16 + b$.

<Example1> What is the decimal expression of 5AH?

From the preceding table, 5AH = 90

<Example2> What is the decimal expression of the value 12 34H given as hexadecimal for each 7 bits?

From the preceding table, since 12H = 18 and 34H = 52
 $18 \times 128 + 52 = 2356$

<Example3> What is the decimal expression of the nibbled value 0A 03 09 0D?

From the preceding table, since 0AH = 10, 03H = 3, 09H = 9, 0DH = 13
 $((10 \times 16 + 3) \times 16 + 9) \times 16 + 13 = 41885$

<Example4> What is the nibbled expression of the decimal value 1258?

```

16 ) 1258
   ) 78 ...10
   ) 4 ...14
   ) 0 ... 4

```

Since from the preceding table, 0 = 00H, 4 = 04H, 14 = 0EH, 10 = 0AH, the result is: 00 04 0E 0AH.

Examples of Actual MIDI Messages

<Example1> 92 3E 5F

9n is the Note-on status, and n is the MIDI channel number. Since 2H = 2, 3EH = 62, and 5FH = 95, this is a Note-on message with MIDI CH = 3, note number 62 (note name is D4), and velocity 95.

<Example2> CE 49

CnH is the Program Change status, and n is the MIDI channel number. Since EH = 14 and 49H = 73, this is a Program Change message with MIDI CH = 15, program number 74.

<Example3> EA 00 28

EnH is the Pitch Bend Change status, and n is the MIDI channel number. The 2nd byte (00H = 0) is the LSB and the 3rd byte (28H = 40) is the MSB, but Pitch Bend Value is a signed number in which 40 00H (= $64 \times 12 + 80 = 8192$) is 0, so this Pitch Bend Value is $28 \text{ 00H} - 40 \text{ 00H} = 40 \times 12 + 80 - (64 \times 12 + 80) = 5120 - 8192 = -3072$

If the Pitch Bend Sensitivity is set to 2 semitones, -8192 (00 00H) will cause the pitch to change -200 cents, so in this case $-200 \times (-3072) \div (-8192) = -75$ cents of Pitch Bend is being applied to MIDI channel 11.

<Example4> B3 64 00 65 00 06 0C 26 00 64 7F 65 7F

BnH is the Control Change status, and n is the MIDI channel number. For Control Changes, the 2nd byte is the control number, and the 3rd byte is the value. In a case in which two or more messages consecutive messages have the same status, MIDI has a provision called "running status" which allows the status byte of the second and following messages to be omitted. Thus, the above messages have the following meaning.

B3	64 00	MIDI ch.4, lower byte of RPN parameter number:	00H
(B3)	65 00	(MIDI ch.4) upper byte of RPN parameter number:	00H
(B3)	06 0C	(MIDI ch.4) upper byte of parameter value:	0CH
(B3)	26 00	(MIDI ch.4) lower byte of parameter value:	00H
(B3)	64 7F	(MIDI ch.4) lower byte of RPN parameter number:	7FH
(B3)	65 7F	(MIDI ch.4) upper byte of RPN parameter number:	7FH

In other words, the above messages specify a value of 0C 00H for RPN parameter number 00 00H on MIDI channel 4, and then set the RPN parameter number to 7F 7FH.

RPN parameter number 00 00H is Pitch Bend Sensitivity, and the MSB of the value indicates semitone units, so a value of 0CH = 12 sets the maximum pitch bend range to +/-12 semitones (1 octave). (On GS sound generators the LSB of Pitch Bend Sensitivity is ignored, but the LSB should be transmitted anyway (with a value of 0) so that operation will be correct on any device.)

Once the parameter number has been specified for RPN or NRPN, all Data Entry messages transmitted on that same channel will be valid, so after the desired value has been transmitted, it is a good idea to set the parameter number to 7F 7FH to prevent accidents. This is the reason for the (B3) 64 7F (B3) 65 7F at the end.

It is not desirable for performance data (such as Standard MIDI File data) to contain many events with running status as given in <Example 4>. This is because if playback is halted during the song and then rewound or fast-forwarded, the sequencer may not be able to transmit the correct status, and the sound generator will then misinterpret the data. Take care to give each event its own status.

It is also necessary that the RPN or NRPN parameter number setting and the value setting be done in the proper order. On some sequencers, events occurring in the same (or consecutive) clock may be transmitted in an order different than the order in which they were received. For this reason it is a good idea to slightly skew the time of each event (about 1 tick for TPQN = 96, and about 5 ticks for TPQN = 480).

* TPQN: Ticks Per Quarter Note

■ Example of an Exclusive Message and Calculating a Checksum

Roland Exclusive messages (RQ1, DT1) are transmitted with a checksum at the end (before F7) to make sure that the message was correctly received. The value of the checksum is determined by the address and data (or size) of the transmitted Exclusive message.

● How to calculate the checksum (hexadecimal numbers are indicated by "H")

The checksum is a value derived by adding the address, size, and checksum itself and inverting the lower 7 bits.

Here's an example of how the checksum is calculated. We will assume that in the Exclusive message we are transmitting, the address is aabbccddH and the data or size is eeffH.

aa + bb + cc + dd + ee + ff = sum
 sum ÷ 128 = quotient ... remainder
 128 - remainder = checksum

<Example> Setting CHORUS TYPE of PERFORMANCE COMMON to DELAY (DT1)

According to the **Parameter Address Map** (P.311), the start address of Temporary Performance is 10 00 00 00H, the offset address of CHORUS at PERFORMANCE COMMON is 04 00H, and the address of CHORUS TYPE is 00 00H. Therefore the address of CHORUS TYPE of PERFORMANCE COMMON is;

```

10 00 00 00H
   04 00H
+) 00 00H
-----
10 00 04 00H
    
```

DELAY has the value of 02H.
 So the system exclusive message should be sent is;

F0 41 10 00 6B 12 10 00 04 00 02 ?? F7
 (1) (2) (3) (4) (5) address data checksum (6)

(1) Exclusive Status (2) ID (Roland) (3) Device ID (17)
 (4) Model ID (Fantom-X6/X7/X8) (5) Command ID (DT1) (6) End of Exclusive

Then calculate the checksum.

10H + 00H + 04H + 00H + 02H = 16 + 0 + 4 + 0 + 2 = 22 (sum)
 22 (sum) ÷ 128 = 0 (quotient) ... 22 (remainder)
 checksum = 128 - 22 (remainder) = 106 = 6AH

This means that F0 41 10 00 6B 12 10 00 04 00 02 6A F7 is the message should be sent.

■ The Scale Tune Feature (address: 40 1x 40)

The scale tune feature allows you to finely adjust the individual pitch of the notes from C through B. Though the settings are made while working with one octave, the fine adjustments will affect all octaves. By making the appropriate Scale Tune settings, you can obtain a complete variety of tuning methods other than equal temperament. As examples, three possible types of scale setting are explained below.

* The scale tune value received by the part 1 is used in Patch mode and Piano mode.

○ Equal Temperament

This method of tuning divides the octave into 12 equal parts. It is currently the most widely used form of tuning, especially in occidental music. On the Fantom, the default settings for the Scale Tune feature produce equal temperament.

○ Just Temperament (Tonic of C)

The principal triads resound much more beautifully than with equal temperament, but this benefit can only be obtained in one key. If transposed, the chords tend to become ambiguous. The example given involves settings for a key in which C is the keynote.

○ Arabian Scale

By altering the setting for Scale Tune, you can obtain a variety of other tunings suited for ethnic music. For example, the settings introduced below will set the unit to use the Arabian Scale.

Example Settings

Note name	Equal Temperament	Just Temperament (Key-tone C)	Arabian Scale
C	0	0	-6
C#	0	-8	+45
D	0	+4	-2
Eb	0	+16	-12
E	0	-14	-51
F	0	-2	-8
F#	0	-10	+43
G	0	+2	-4
G#	0	+14	+47
A	0	-16	0
Bb	0	+14	-10
B	0	-12	-49

The values in the table are given in cents. Convert these values to hexadecimal, and transmit them as Exclusive data.

For example, to set the tune (C-B) of the Part 1 Arabian Scale, send the following data:

F0 41 10 42 12 40 11 40 3A 6D 3E 34 0D 38 6B 3C 6F 40 36 0F 76 F7

■ ASCII Code Table

Patch Name and Performance Name, etc., of MIDI data are described the ASCII code in the table below.

D	H	Char	D	H	Char	D	H	Char
32	20H	SP	64	40H	@	96	60H	`
33	21H	!	65	41H	A	97	61H	a
34	22H	"	66	42H	B	98	62H	b
35	23H	#	67	43H	C	99	63H	c
36	24H	\$	68	44H	D	100	64H	d
37	25H	%	69	45H	E	101	65H	e
38	26H	&	70	46H	F	102	66H	f
39	27H	`	71	47H	G	103	67H	g
40	28H	(72	48H	H	104	68H	h
41	29H)	73	49H	I	105	69H	i
42	2AH	*	74	4AH	J	106	6AH	j
43	2BH	+	75	4BH	K	107	6BH	k
44	2CH	,	76	4CH	L	108	6CH	l
45	2DH	-	77	4DH	M	109	6DH	m
46	2EH	.	78	4EH	N	110	6EH	n
47	2FH	/	79	4FH	O	111	6FH	o
48	30H	0	80	50H	P	112	70H	p
49	31H	1	81	51H	Q	113	71H	q
50	32H	2	82	52H	R	114	72H	r
51	33H	3	83	53H	S	115	73H	s
52	34H	4	84	54H	T	116	74H	t
53	35H	5	85	55H	U	117	75H	u
54	36H	6	86	56H	V	118	76H	v
55	37H	7	87	57H	W	119	77H	w
56	38H	8	88	58H	X	120	78H	x
57	39H	9	89	59H	Y	121	79H	y
58	3AH	:	90	5AH	Z	122	7AH	z
59	3BH	;	91	5BH	[123	7BH	{
60	3CH	<	92	5CH	\	124	7CH	
61	3DH	=	93	5DH]	125	7DH	}
62	3EH	>	94	5EH	^			
63	3FH	?	95	5FH	_			

D: decimal

H: hexadecimal

* "SP" is space.

<Bank Select and Program Change Correspondence Chart>

Patch

Group	Number	Bank Select		Program Number
		MSB	LSB	
USER	001-128	87	0	1-128
	129-256	87	1	1-128
CARD	001-128	87	32	1-128
	129-256	87	33	1-128
PR-A	001-128	87	64	1-128
PR-B	001-128	87	65	1-128
PR-C	001-128	87	66	1-128
PR-D	001-128	87	67	1-128
PR-E	001-128	87	68	1-128
PR-F	001-128	87	69	1-128
PR-G	001-128	87	70	1-128
PR-H	001-128	87	71	1-128
GM(2)	001-256	121	0-	1-128
XP-A (SRX-01) (SRX-02) :	001-	93	0	1-
	001-	93	1	1-
	:	:	:	:
XP-B (SRX-01) (SRX-02) :	001-	93	0	1-
	001-	93	1	1-
	:	:	:	:
XP-C (SRX-01) (SRX-02) :	001-	93	0	1-
	001-	93	1	1-
	:	:	:	:
XP-D (SRX-01) (SRX-02) :	001-	93	0	1-
	001-	93	1	1-
	:	:	:	:

* The XP groups vary depending on the Wave Expansion Board(s) you've installed. For information about an SRX series board, refer to the Owner's Manual that came with it.

Rhythm Set

Group	Number	Bank Select		Program Number
		MSB	LSB	
USER	001-032	86	0	1-32
CARD	001-032	86	32	1-32
PRST	001-040	86	64	1-40
GM(2)	001-009	120	---	1-57
XP-A (SRX-01) (SRX-02) :	001-	92	0	1-
	001-	92	1	1-
	:	:	:	:
XP-B (SRX-01) (SRX-02) :	001-	92	0	1-
	001-	92	1	1-
	:	:	:	:
XP-C (SRX-01) (SRX-02) :	001-	92	0	1-
	001-	92	1	1-
	:	:	:	:
XP-D (SRX-01) (SRX-02) :	001-	92	0	1-
	001-	92	1	1-
	:	:	:	:

* The XP groups vary depending on the Wave Expansion Board(s) you've installed. For information about an SRX series board, refer to the Owner's Manual that came with it.

Performance

Group	Number	Bank Select		Program Number
		MSB	LSB	
USER	01-64	85	0	1-64
CARD	01-64	85	32	1-64
PRST	01-64	85	64	1-64

* To switch multitimbres, the external MIDI device's transmit channel needs to be matched up with the Control Channel of the Fantom-X. (P.230)

MIDI Implementation Chart

Function...	Transmitted	Recognized	Remarks
Basic Channel Default Changed	All channel X	All channel 1-16	There is no specific basic channel.
Mode Default Messages Altered	X X *****	X X	
Note Number : True Voice	0-127 *****	0-127 0-127	
Velocity Note On Note Off	O O	O O	
After Touch Key's Channel's	O O	O O	*1 *1
Pitch Bend	O	O	*1
Control Change 0-119	O	O	*1
Program Change : True Number	O *****	O 0-127	*1
System Exclusive	O	O	*1
System Common : Quarter Frames : Song Position : Song Select : Tune Request	O O X O	O O X O	*1 *1 *1
System Real Time : Clock : Commands	O O	O O	*1 *1
Aux Messages : All Sound Off : Reset All Controllers : Local On/Off : All Notes Off : Active Sensing : System Reset	O O X O O X	O O X O (123-127) O X	*2 *3 *3
Notes	*1 O X is selectable. *2 Not stored/transmitted when received, but can be created and transmitted using Microscope. *3 Mode Messages (123-127) are recorded and transmitted, after all currently sounding notes are turned off. The All Note Message itself is not recorded or transmitted. However, it can be created in Microscope and transmitted.		

Mode 1 : OMNI ON, POLY
Mode 3 : OMNI OFF, POLY

Mode 2 : OMNI ON, MONO
Mode 4 : OMNI OFF, MONO

O : Yes
X : No

Specifications

Fantom-X6/X7/X8:

Synthesizer Keyboard (Conforms to General MIDI 2 System)

Keyboard

[X6] 61 keys	(with velocity and channel aftertouch)
[X7] 76 keys	(with velocity and channel aftertouch)
[X8] 88 keys	(Progressive Hammer action Mechanism and channel aftertouch)

Sound Generator Section

Maximum Polyphony

128 voices (shared with the sampling section)

Parts

16 parts

Wave Memory

128 M bytes (16-bit linear equivalent)

Waveforms

1,480

Preset Memory

Patches:	1,024 + 256 (GM2)
Rhythm Sets:	40 + 9 (GM2)
Performances:	64

User Memory

Patches:	256
Rhythm Sets:	32
Performances:	64

Card Memory (PC card)

Patches:	256
Rhythm Sets:	32
Performances:	64

Effects

Multi-Effects:	3 systems, 78 types
Chorus:	3 types
Reverb:	5 types
Input Effects:	6 types
Mastering Effects:	3-band compressor

Sampling Section

Data Format

16-bit linear (File Type: .WAV/.AIFF)

Sampling Frequency

44.1 kHz (fixed)

Maximum Sampling Time

- When sampling memory isn't expanded (32 MB)
mono: 360 sec. approx., stereo: 180 sec. approx.
- When sampling memory is expanded with DIMM (544 MB)
mono: 107 min. approx., stereo: 53 min. approx.

Number of Samples

User memory: 2,000 (maximum total approximately 32 MB)
Card memory: 7,000 (PC card)

Sequencer Section

Tracks

Phrase tracks (16 MIDI channels per track): 16
Tempo track: 1
Beat track: 1

Patterns

100

* *Up to one hundred patterns can be created in a song*

Resolution

480 TPQN

Tempo

5–300

Note Capacity

approx. 400,000 notes

Song Length

9,998 measures

Recording Method

Realtime recording, Step recording

Others

Arpeggio

Preset:	128
User:	128

Rhythm Pattern

Preset:	256 (32 groups)
User:	256 (32 groups)

Specifications

Chord Memory

Preset: 64
User: 64

Display

Graphic 320 x 240 dots backlit LCD (Color)

Pads

16 pads, Velocity and Aftertouch sensitive

Controllers

Pitch Bend/Modulation Lever
Control Knob x 4
Assignable Switch x 2
D Beam Controller

Connectors

Headphones Jack
A (MIX) Output Jacks (L/MONO, R): 1/4 inch TRS phone type
B Output Jacks (L, R): 1/4 inch phone type
Input Jacks (L/MONO/MIC, R): 1/4 inch phone type
Hold Pedal Jack (Half Pedal recognition)
Control Pedal Jack (assignable)
MIDI Connectors (IN, OUT, THRU)
USB Connector (supports file transfer (mass storage class) and MIDI)
Digital Audio Interface (COAXIAL INPUT/OUTPUT)
AC Inlet

Expansion Slots

- Expansion of waveforms and patches for the internal sound generator
SRX expansion boards: 4 slots
- Expansion of sampling memory
DIMM: 1 slot (supports 128 MB, 256 MB, 512 MB (3.3 V))

External Storage Device

PC card: 1 slot (supports SmartMedia and CompactFlash using a PC card adapter)

Power Supply

AC 117 V, AC 230 V, AC 240 V (50/60 Hz)
AC 220 V (60 Hz)

Power Consumption

17 W

Dimensions

[X6] 1,050 (W) x 358 (D) x 125 (H) mm
41-3/8 (W) x 14-1/8 (D) x 4-15/16 (H) inches
[X7] 1,262 (W) 358 (D) x 125 (H) mm
49-11/16 (W) x 14-1/8 (D) x 4-15/16 (H) inches
[X8] 1,408 (W) 455 (D) x 165 (H) mm
55-7/16 (W) x 17-15/16 (D) x 6-1/2 (H) inches

Weight

[X6] 12.5 kg / 27 lbs 9 oz
[X7] 14.5 kg / 32 lbs
[X8] 29.5 kg / 65 lbs 1 oz

Accessories

Handbook
Owner's Manual
Sample Data (Audio) CD
CD-ROM (Editor, USB MIDI driver)
PC Card Protector
Power Cord

Options

Wave Expansion Board: SRX Series
Keyboard Stand: [X6] [X7] KS-12 / [X8] KS-17
Pedal Switch: DP series
Foot Switch: BOSS FS-5U
Expression Pedal: EV-5

* *In the interest of product improvement, the specifications and/or appearance of this unit are subject to change without prior notice.*

Index

Symbols

+OCT/-OCT	24
.BMP	220
.MID	31
.SVQ	31, 223
.TXT	220, 223
.WAV	148, 202, 220, 223

A

A-Env Level 1-3	
Patch	73
Rhythm Set	95
A-Env T1 V-Sens	
Patch	72
Rhythm Set	94
A-Env T4 V-Sens	
Patch	73
Rhythm Set	94
A-Env Time 1-4	
Patch	73
Rhythm Set	94
A-Env Time KF	73
Aftertouch	24
Aftertouch Sens	162, 226
Aftertouch Time Ctrl Sens	88
AIFF	148, 202, 220, 223
All Reset	239
Alternate Pan Depth	
Patch	72
Rhythm Set	94
Amp	156
Analog Feel	61
Arabian Scale	
Performance	112
System Function	232
Arp Accent	124, 130
Arp Motif	130
Arp Part	130
Arp Range	124
Arp Velocity	130
Arp/Rhythm Duration	130
Arp/Rhythm Grid	129
Arpeggio	128
Holding	128
On/Off	128
Arpeggio Style	129
Arpeggio Style Edit	131, 138
Arpeggio/Rhythm Sync Switch	227
Assign a Name	
File Name	199
Rhythm Tone Name	87
Assign to Keyboard	152
Assign To Pad	151
Assign Type	87
Assignable	50
Control Setting	114
D Beam	50, 116, 122
Assignable Sw	51

Assignable Switches	46
Attack	124, 217
Attack Time Offset	62
Auditioning	
Patch	42
Auto Chop	158
Auto divide sampling	143
Auto Punch-In	171
Auto Trigger	143
Auto Trigger Level	143

B

Background	233
Background Picture	233
Backing Up	
User Data	235
Base Note	161
Beat	
Auto Chop	158
Track Edit	185
Beat Track	31
Bend Range Down	67
Bend Range Up	67
Bias	
Patch	72
Track Edit	186-187, 190
Bias Direction	72
Bias Level	72
Bias Position	72
Bitmap File	221
BMP	220
Bookmark	37
Booster 1&2, 3&4	65
BPM	
Sample	150
Brightness Ctrl	239

C	
Card	
File	223
Format	223
Patch	39
Performance	99
Sample	146
Song	199
Storage	219
USER	52
Card Format	224
Category	61
Ch/Part	
Change Duration	187
Change Velocity	186
Copy	184
Data Thin	190
Erase	183
Extract	188
Quantize	181
Shift Clock	189
Transpose	185
Chain Play	164
Change Channel	186
Change Duration	187
Change Velocity	186
Chop	157
Chop Type	158
Chord	
Step Recording	175
Chord Form	133
Chord Memory	133
Chorus	29, 215
Chorus Level	209, 211
Chorus Output Assign	209, 211
Chorus Output Select	209, 211
Chorus Send Level	49, 115, 124
Chorus Source	108, 209, 212
Chorus Type	208, 211
Clip 1 Note No.	239
Clip filter	239
Clip Reset	239
Color Cb Ctrl	239
Color Cr Ctrl	239
Combine	158
Compare	58
Patch	60
Rhythm Set	86
Compare Function	
Rhythm Set	85
Connecting	
Amp and Speaker System	19
Continuous Hold Pedal	126, 226
Control Aftertouch	118
Control Bender	118
Control D Beam	119
Control Hold Pedal	118
Control Knob	119
Control Modulation	118
Control Pedal	25, 118, 126
Control Pedal Assign	126, 226
Control Pedal Polarity	126, 226
Control Setting	47, 114
Controller Section	26
Copy	195, 224
Patch (Tone) Setting	58
Phrases	184
Rhythm Tone Setting	84
Copy Mode	184
Copy Times	184
Copying	
File	224
Patch (Tone) Setting	58
Rhythm Tone Setting	84
Count In	170
Create	194
Create Multisample	153
Create Rhythm	152
Ctrl	114
CTRL Destination 1–4	81
CTRL Sens 1–4	82
Ctrl Switch	118
CTRL Tone 1–4	82
Ctrl Tx Ch	239
Ctrl1–4	80
Current Part	100
Cursor	34
Cutoff	49, 115, 123–124
Cutoff Frequency	
Patch	69
Rhythm Set	92
Cutoff Key follow	70
Cutoff Offset	61
Cutoff V-Curve	
Patch	70
Rhythm Set	92
Cutoff V-Sens	
Patch	70
Rhythm Set	93
D	
D Beam	
Assignable	50, 116
Pad Trigger	48, 114
Solo Synth	49, 115
D Beam Controller	121
D Beam Sens	226
Data Thin	190
Data Thin Time	190
Data Thin Value	190
DEC	35
Default File Type	233
Delay Time	75
Delay Time KF	75
Delete	184, 224

- Deleting
 Dividing Point 158
 File 224
 Measure 184
 Sample 147
 Demo Song 23
 Destination 1–4 214
 Device ID 230
 Digital Input Level 141
 Dissolve Time 239
 Drop Format 228
 Dst 184
 Dst Measure 184
 Dst Track / Pattern
 Track Edit 184, 188
 Duration 137
- E**
- Editing
 Micro Edit 192
 Patch 56
 Performance 107
 Rhythm Group 139
 Sample 146
 Song 177
 Track Edit 180
 Editor 236
 Effect 29, 206
 Patch Mode 207
 Performance Mode 210
 Emphasis 155
 End Point
 Loop Point 179
 Punch-In Recording 171
 Selecting 149
 Envelope 26
 Equal Temperament
 Performance 112
 System Function 232
 Erase 195
 Song 183
 Exchange 191
 Expanding
 Memory 244
 Ext Bank Select LSB 112
 Ext Bank Select MSB 112
 Ext Level 112
 Ext Pan 113
 Ext Program Number 112
 Extract 188
- F**
- Factory Reset 235
 Fade Ctrl 239
 Fade Mode 75
 Fade Time 75
 Fantom-X Editor 236
 Fantom-X Librarian 236
- Favorite Patch 44
 Features 234
 F-Env Depth
 Patch 71
 Rhythm Set 93
 F-Env Level 0–4
 Patch 71
 F-Env Level 1–4
 Rhythm Set 93
 F-Env T1 V-Sens
 Patch 70
 Rhythm Set 93
 F-Env T4 V-Sens
 Patch 70
 Rhythm Set 93
 F-Env Time 1–4
 Patch 71
 Rhythm Set 93
 F-Env Time KF 71
 F-Env V-Curve
 Patch 70
 Rhythm Set 93
 F-Env V-Sens
 Patch 70
 Rhythm Set 93
 File 223
 File Name 199
 File Utility 223
 Filter 69
 Filter Type 49, 115, 123
 Patch 69
 Rhythm Set 92
 Function Button 34
 FXM 63, 89
 FXM Color
 Patch 63
 Rhythm Set 89
 FXM Depth
 Patch 63
 Rhythm Set 89
 FXM Switch
 Patch 63
 Rhythm Set 89
- G**
- Gap Time 143, 233
 Gate Time 174
 General
 Patch 60
 Rhythm Set 87
 GM
 Patch 39
 Rhythm Set 52
 GM2
 Patch 39
 Rhythm Set 52
 Grid 137
 Grid Resolution 172

H

Hold	160
Hold Pedal	24
Hold Pedal Polarity	
Control Pedal	126
System Parameter	226

I

Import	
Audio File	148
Text File	221
Import Audio	148, 202, 220
Import BMP	43, 221
Import Text	221
Importing	
Audio file	220
Bitmap File	221
WAV/AIFF File	202
INC	35
Initializing	
Memory Card	224
Patch Setting	57
Performance Setting	119
Rhythm Set Settings	84
Input Effect	142
Input Effect Setup	142
Input Effect SW	141
Input Effect Type	141
Input Quantize	172
Input Select	141, 143, 233
Input Setting	141, 143
Input Source	141
Input Velo	174
Insert	185

J

Just Temperament	112
System Function	232

K

Kbd Patch Rx/Tx Ch	230
KBD/PAD Mute Group	204
KBD/PAD Pattern	204
KBD/PAD Playback Mode	204
Key Fade Lower	65
Key Fade Upper	66
Key Range Lower	65
Key Range Upper	65
Key Touch	54
Key Trigger	75
Keyboard	226
Keyboard Note	204
Keyboard Range Lower	110
Keyboard Range Upper	111
Keyboard Sens	226
Keyboard Switch	101, 103, 107, 110
Keyboard Velocity	226
Knob	47, 51, 117, 124–125

Arpeggio	131
Assign	125
Effect	213
Rhythm Pattern	136
Selecting	149
Knob Assign 1–4	51, 117, 125

L

Layer	33, 97, 100, 102
LCD Contrast	22
Legato Retrigger	77
Legato Switch	77
Level	217
Auto Chop	158
D Beam	49, 115, 124
Level V-Curve	
Patch	71
Rhythm Set	94
Level V-Sens	
Patch	71
Rhythm Set	94
LFO	27, 124
LFO 1/2	74
LFO Osc 1 Pitch Depth	50, 115, 124
LFO Osc 1 Pulse Width Depth	50, 116, 124
LFO Osc 2 Pitch Depth	50, 116, 124
LFO Osc 2 Pulse Width Depth	50, 116, 124
LFO Rate	49, 74, 115, 124
LFO Step Type	76
Librarian	236
Live Setting	42
Live Setting function	99
Load	201
Load All Samples	202
Load Demo Song	234
Load Preset Sample at Stratup	234
Load Song	202
Load Song+Samples	201
Load User Samples at Stratup	234
Loading	
Sample	147, 202
Song	177, 201–202
Song with Samples	201
Local Switch	229, 239
Locate Position	179
Loop End Fine	150
Loop Mode	150
Loop Play	166
Loop Point	179
Loop Recording	171
Loop Start	149
Loop Start Fine	150
Loop Tune	150
Loop/Punch	171
Low Frequency Oscillator	27

- M**
- Magnify 186–187
 - Manual Punch-In 171
 - Master Key Shift 230
 - Master Level 229
 - Master Tune 229
 - Mastering 217
 - Mastering Effect 29, 217
 - Matrix Control 80
 - Matrix Control 1–4 Source 81
 - Measure, For
 - Change Channel 187
 - Change Duration 187
 - Change Velocity 186
 - Data Thin 190
 - Delete 184
 - Erase 183
 - Extract 188
 - Insert 185
 - Quantize 181
 - Shift Clock 189
 - Time Fit 191
 - Transpose 185
 - Memo
 - Live Setting Screen 221
 - Memory 28, 244
 - Memory Card 29, 31, 52, 248
 - Patch 39
 - Performance 99
 - Memory Info 234
 - Merge 188
 - Metronome 228
 - Metronome Level 228
 - Metronome Mode 228
 - Metronome Sound 228
 - MFX
 - HUMANIZER 273
 - RING MODULATOR 275
 - MFX 1–3 Control Channel 118
 - MFX Chorus Send Level 208, 211
 - MFX Control 213
 - MFX Control Channel 214
 - MFX Ctrl Ch 118
 - MFX Output Assign 208, 211
 - MFX Output Level 208, 211
 - MFX Reverb Send Level 208, 211
 - MFX Structure 215
 - MFX Type 208, 211
 - MFX1–3 213
 - MFX1–3 Source 108, 212
 - MFX1–3 TYPE 215
 - Micro Edit 192
 - MIDI 222, 230
 - MIDI Channel 186
 - Change Duration 187
 - Change Velocity 186
 - Copy 184
 - Data Thin 190
 - Erase 183
 - Extract 188
 - Quantize 181
 - Shift Clock 189
 - Transpose 185
 - MIDI Clock 227
 - MIDI Mode 218, 222
 - MIDI Update 165
 - Misc 78
 - Mix In Chorus Send Level 141
 - Mix In Output Asgn 141
 - Mix In Output Level 141
 - Mix In Reverb Send Level 141
 - Mix Sampling 143
 - Mix/Parallel 230
 - Mixer 33, 97, 103
 - MMC Mode 227
 - MMC Output 227
 - Mode 33
 - Modulation Lever 24
 - Mono 46
 - Mono/Poly 77
 - Move 195, 224
 - Moving
 - Dividing Point 158
 - File 224
 - MTC 227–228
 - MTC Error Level 228
 - MTC Frame Rate 227
 - MTC Offset Time Frame 228
 - MTC Offset Time Hour 228
 - MTC Offset Time Minute 228
 - MTC Offset Time Second 228
 - MTC Sync Output 227
 - Multi 214
 - Multi-Effects 29, 213
 - Multi-Effects 1 Source 212
 - Multi-Effects Chorus Send Level 208, 211
 - Multi-Effects Control 213–214
 - Multi-Effects Control Channel 214
 - Multi-Effects Output Assign 208, 211
 - Multi-Effects Output Level 208, 211
 - Multi-Effects Reverb Send Level 208, 211
 - Multi-Effects Structure 215
 - Multi-Effects Type 208, 211
 - Multisample 32, 153
 - Mute 105, 178
 - Mute Group 87
 - Mute Part 105
 - Mute Switch 107
 - Muting
 - Tempo Track 166

N

Name	36
File Name	199
Song Name	197
Non-Drop Format	228
Normalize	156
Note	161
Note Tx Ch	239
Note Type	174
Number of Voices	111

O

Oct	24
Oct Range	131
Octave Shift	24, 45, 61
On/Off	
Chord Memory	133
Effects	206
Rhythm	135
Switching external input	141
V-LINK	238
One Shot Mode	88
Open/Close	55
Original Key	150
OSC 1/2 Coarse Tune	49, 115, 123
OSC 1/2 Fine Tune	49, 115, 123
OSC 1/2 Pulse Width	49, 115, 123
OSC 1/2 Waveform	49, 115, 123
OSC Sync Switch	49
OSC1 Sync Switch	115, 123
OSC2 Level	49, 115, 123
Output	73
Output Gain	230

P

Pad	122, 160
Mute Part	105
Rhythm Pattern	135
RPS	203
Sample	151
Pad Common Velo	162
Pad Control Mode	48, 114, 123
PAD MODE	239
PAD Number	204
Pad Number	48, 114, 122
Pad Part	161
Pad Patch Rx/Tx Ch	230
Pad Sens	162
Pad Setting	161
Pad Trigger	122
Pad Velocity	48, 114, 122
Pan Depth	76
Pan Key Follow	
Patch	72
Part	27
Part Attack Time Offset	110
Part Chorus Send Level	108, 210
Part Coarse Tune	109

Part Cutoff Offset	110
Part Decay Time Offset	110
Part Fine Tune	109
Part Information	106
Part Legato Switch	109
Part Level	108
Part Mono/Poly	109
Part Octave Shift	109
Part Output Assign	108, 210
Part Output Level	108, 210
Part Output MFX Select	108, 210
Part Pan	108
Part Pitch Bend Range	109
Part Portamento Switch	109
Part Portamento Time	109
Part Release Time Offset	110
Part Resonance Offset	110
Part Reverb Send Level	108, 211
Part Select	207, 210
Part Velocity Sensitivity Offset	111
Part Vibrato Delay	111
Part Vibrato Depth	111
Part Vibrato Rate	111
Patch	61
Card	39
GM	39
GM2	39
Memory Card	39
PR-A-H	39
Preset A-H	39
USER	39
Wave Expansion Board	39
XP-A-D	39
Patch Bank	107
Patch Category	61
Patch Coarse Tune	61
Patch Finder	40
Patch Fine Tune	61
Patch Level	61
Patch mode	33
Patch Number	107
Patch Out Assign	73
Patch Output Assign	207
Patch Pan	61
Patch Parameter	60
Patch Play Screen	38
Patch Priority	61
Patch Remain	230
Patch Scale Tune for C-B	232
Patch Type	107
Patch/Rhythm Set Group	161
Patch/Rhythm Set Number	161
Patch/Rhythm Set Type	161
Patches	27
Pattern	31
PC Card Protector	248
PC card slot	248
Pedal/D Beam	226

- P-Env Depth
 - Patch 68
 - Rhythm Set 91
 - P-Env Level 0–4
 - Patch 68
 - Rhythm Set 91
 - P-Env T1 V-Sens
 - Patch 67
 - Rhythm Set 91
 - P-Env T4 V-Sens
 - Patch 68
 - Rhythm Set 91
 - P-Env Time 1–4
 - Patch 68
 - Rhythm Set 91
 - P-Env Time KF 68
 - P-Env V-Sens
 - Patch 67
 - Rhythm Set 91
 - Performance 27
 - Card 99
 - Memory Card 99
 - Preset 99
 - PRST 99
 - USER 99
 - Performance Control Channel 230
 - Performance Layer Screen 97–98
 - Performance Mixer Screen 97–98
 - Performance Mode 33
 - Performance Part View 106–107
 - Phase Lock 113
 - Phrase Loop 63, 89
 - Phrase Preview 42
 - Phrase Track 30
 - Piano Mode 54
 - Pitch
 - Patch 67
 - Rhythm Set 91
 - Pitch Bend 24
 - Pitch Depth 75
 - Pitch Env
 - Patch 68
 - Rhythm Set 91
 - Play Speed Ctrl 239
 - Playing Back
 - Demo Song 23
 - Song 164
 - Portamento 47, 77
 - Portamento Mode 77
 - Portamento Start 78
 - Portamento Switch 77
 - Portamento Time 78
 - Portamento Type 77
 - Power 21
 - Power Up Mode 234
 - PR-A–H 39
 - Pre Sample Time 143, 233
 - Preset 52
 - Performance 99
 - Preset A–H
 - Patch 39
 - Preset Memory 29
 - Preview 232
 - Preview 1–4 Note Number 232
 - Preview 1–4 Velocity 232
 - Preview Function 183
 - Preview Mode 232
 - PRST
 - Performance 99
 - Punch-In Recording 171
- ## Q
- Quantize 181
 - Quantize Template 182
 - Quantize Type 181
 - Quick Play 164
- ## R
- Random Pan Depth
 - Patch 72
 - Rhythm Set 94
 - Random Pitch Depth 67
 - Range 50, 116, 124
 - Range Max 50, 116, 122
 - Range Min 50, 116, 122
 - Range Min, Range Max 183, 185–187, 189–191
 - Rate 172, 182
 - Rate Detune 75
 - RATIO 217
 - Realtime Control Knob 47
 - Arpeggio 131
 - Assign 125
 - Effect 213
 - Rhythm Pattern 136
 - Selecting 149
 - Realtime Controller 124
 - Realtime Controller Knob 125
 - Realtime Erase 173
 - Realtime Recording 170
 - Realtime Time Stretch 63, 89
 - Rec Mode
 - Realtime Recording 170
 - Step Recording 174, 176
 - Rec Track
 - Realtime Recording 170
 - Step Recording 174, 176
 - Receive Bank Select
 - MIDI Filter 113
 - System Function 231
 - Receive Channel 112
 - Receive Channel Pressure 113
 - Receive Exclusive 231
 - Receive Expression 113
 - Receive GM System On 231
 - Receive GM2 System On 231
 - Receive GS Reset 231

Receive Hold 1	113	Routing	207, 210
Receive Modulation	113	RPS Function	203
Receive Pan	113	S	
Receive Pitch Bend	113	Sample	32
Receive Polyphonic Key Pressure	113	Sample Edit Screen	148
Receive Program Change	113, 231	Sample List	146
Receive Switch	112	Sample Parameters	150
Receive Volume	113	Sampling	32, 141
Recommended Tempo	118	System	233
Record		Sampling Length	143
RPS	203	Sampling mode	142
Recording		Save	198
Song	168	Save All Samples	200
Recording Quantize	172	Save as SMF	200
Recording Select	172	Save Song	199
Rehearsal Function	173	Save Song+Samples	199
Release	124, 217	Saving	
Release Time Offset	62	Arpeggio Style	132
Remote Keyboard Switch	231	Chord Form	134
Repeat	179	Patch	59
Re-Sampling	143	Piano Mode	55
Reset Grid function	149	Rhythm Group	140
Resolution	181	Rhythm Pattern	139
Resonance	124	Rhythm Set	86
D Beam	49, 115, 124	Sample	159, 200
Patch	69	Song	198–200
Piano Mode	55	System Function	225
Rhythm Set	92	System Settings	225
Resonance Offset	62	Scale Tune	111, 232
Resonance V-Sens		Scale Tune Switch	232
Patch	70	Screen Saver	233
Rhythm Set	93	Screen Saver Time	233
Rest	175	Screen Saver Type	233
Reverb	29, 216	Select	
Reverb Level	209, 212	Rhythm Group	136
Reverb Output Assign	209, 212	Rhythm Pattern	136
Reverb Send Level	49, 115, 124	Sample	146
Reverb Source	108, 209, 212	Selecting	
Reverb Type	209, 212	Editing	146
Rhy Accent	124	Patch	39–40, 44
Rhythm Accent	137	Performance	99
Rhythm Group Edit	139	Rhythm Set	52
Rhythm Groups	135	TONE	46
Rhythm Level	87	Sens 1–4	214
Rhythm Out Assign	95	Sequencer	30
Rhythm Pattern	135	Sequencer Section	26
Rhythm Pattern Velocity	137	Shift Clock	189
Rhythm Set		Shuffle Resolution	172
GM	52	Simultaneous Polyphony	28
USER	52	Skip Back Sampling	145
Wave Expansion Board	52	Skip Back Time	233
XP-A-D	52	S-MRC Format	166
Rhythm Set Parameter	87	Soft Through	231
Rhythm Sets	27	Solo	105
Ring Modulator	65	Solo sampling	143
Roll Function	160	Solo Switch	107
Roll Resolution	162	Solo Synth	123
Rolled Chord	134		

- Solo/Portamento 77
- Song 30
- Playing 164
- Song Clear 168
- Song File 31
- Song Name 197, 199
- Sound Generator Section 26
- Source 1–4 213
- Split 33, 97, 102
- Split Frequency High 217
- Split Frequency Low 217
- Src Channel, Dst Channel 187
- Src Measure, For 184
- Src Track / Pattern
- Copy 184
- Src Track / Src Pattern
- Extract 188
- Merge 188
- SRX Info 234
- Stand 20
- Standard MIDI File 31
- Start Fine 150
- Start Point 149, 171, 176, 179
- Step Recording 174
- Start up 234
- Status
- Change Channel 187
- Copy 185
- Data Thin 191
- Erase 183
- Extract 189
- Shift Clock 190
- Step 1–16 76
- Step Back 175
- Step LFO 76
- Step Recording 174
- Inputting 174
- Stereo Switch 143
- Stop Trigger 143
- Storage Mode 219
- Strength
- Quantize 181
- Recording Quantize 172
- Stretch Tune Depth 61
- Structure Type 215
- Structure Type 1 & 2, 3 & 4 63
- SVQ 31, 223
- Switch 51
- Performance 117
- Switch 1/2 117
- Patch 51
- Switch Assign 125
- Sync Mode 227
- Sync Output 227
- Sync/Temp 227
- Sys Ctrl 1–4 Source 233
- System Control 233
- System Ctrl 233
- System Exclusive Message 192
- System Function 225
- System Information 234
- System Memory 29
- System Parameter 226
- System Write 225
- T**
- Tap Tempo
- Arpeggio 128
- Rhythm Pattern 135
- Song 166, 169
- Template Set 161
- Tempo 118, 128
- Rhythm Pattern 135
- Rhythm Set 124
- Song 166, 169, 196
- Tempo Override 227
- Tempo Rec Sw 171
- Tempo Recording 171
- Tempo Track 31
- Temporary Area 29
- The Compare Function
- Patch 58
- The Sampler section 26
- THRESHOLD 217
- Tie 175
- Time Fit 191
- Time H/M/S 191
- Time Original H/M/S 191
- Time Signature 169, 196
- Time Stretch 156
- Time Stretch Type 150
- Time Variant Amplifier 26
- Time Variant Filter 26
- Times 158
- Timing 182
- TMT 63
- TMT Control Sw 66
- TMT Velocity Control 66
- Tone Chorus Send
- Patch 74
- Rhythm Set 95–96
- Tone Chorus Send Level 208
- Tone Coarse Tune
- Rhythm Set 91
- Tone Delay 79
- Tone Delay Mode 78
- Tone Delay Time 79
- Tone Env Mode
- Patch 79
- Rhythm Set 87
- Tone Fine Tune
- Patch 67
- Rhythm Set 91
- Tone Level
- Patch 71
- Rhythm Set 94

Index

- Tone Name 87
- Tone Out Assign
 - Patch 73
 - Rhythm Set 95
- Tone Out Level
 - Patch 74
 - Rhythm Set 95
- Tone Output Assign 208
- Tone Output Level 208
- Tone Pan
 - Patch 72
 - Rhythm Set 94
- Tone Pitch Bend Range 88
- Tone Random Pitch Depth 91
- Tone Receive Expression 88
- Tone Receive Hold-1 88
- Tone Receive Pan Mode 88
- Tone Redamper Sw 80
- Tone Reverb Send
 - Patch 74
 - Rhythm Set 95–96
- Tone Reverb Send Level 208
- Tone Rx Bender 79
- Tone Rx Expression 79
- Tone Rx Hold-1 79
- Tone Rx Pan Mode 80
- Tone Select 207
- Tones 26
- Track 30
- Track / Pattern
 - Change Channel 186
 - Change Duration 187
 - Change Velocity 186
 - Data Thin 190
 - Delete 184
 - Erase 183
 - Insert 185
 - Quantize 181
 - Shift Clock 189
 - Transpose 185
 - Truncate 191
- Trans 25
- Transmit Active Sensing 230
- Transmit Bank Select 230
- Transmit Edit Data 230
- Transmit Program Change 230
- Transpose 25, 46, 185
- Trigger Level 233
- Trigger Quantize 203
- Trim Sw 143
- Trimming Switch 233
- Truncate 155, 191
- TVA 26
 - Patch 71
 - Rhythm Set 94
- TVA Depth 75
- TVA Env
 - Patch 72
 - Rhythm Set 94
- TVF 26
 - Patch 69
 - Rhythm Set 92
- TVF Depth 75
- TVF Env
 - Patch 71
 - Rhythm Set 93
- TXT 220, 223
- Type
 - Chorus 215
 - D Beam 50, 116, 122
 - Input Effect Type 142
 - Multi-Effects 213
 - Reverb 216
- U**
 - Unload 155
 - Sample 147, 155
 - USB 218, 231
 - Fantom-X Editor 236
 - USB Mode 231
 - USB Storage Mode 218
 - USB-MIDI Thru Sw 231
 - USER
 - Card 52
 - Patch 39
 - Performance 99
 - Rhythm Set 52
 - User Backup 235
 - User Memory 29, 31
 - User Restore 235
 - Using the Clip Filter 239
- V**
 - VALUE Dial 35
 - Velo Fade Lower
 - Patch 66
 - Rhythm Set 90
 - Velo Fade Upper
 - Patch 66
 - Rhythm Set 90
 - Velo Range Lower
 - Patch 66
 - Rhythm Set 90
 - Velo Range Upper
 - Patch 66
 - Rhythm Set 90
 - Velocity 24, 161
 - Velocity Curve 113
 - Velocity Sens 204
 - Velocity Sens Offset 62
 - Version Info 234
 - VFX1–4 Ctrl 239
 - View 194
 - V-LINK 238

Voice Reserve	28, 111
Volume	186
W	
WAV	148, 202, 220, 223
Wave	88
Patch	62
Wave Alter Pan Sw	90
Wave Bank	
Patch	62
Rhythm Set	88
Wave Coarse Tune	89
Wave Expansion Board	240
Patch	39
Rhythm Set	52
Wave Fine Tune	90
Wave Gain	
Patch	63
Rhythm Set	89
Wave Generator	26
Wave Group	
Patch	62
Rhythm Set	88
Wave Level	90
Wave No. L (Mono)	
Patch	62
Rhythm Set	89
Wave No. R	
Patch	62
Rhythm Set	89
Wave Pan	90
Wave Rnd Pan Sw	90
Wave Tempo Sync	
Patch	63
Waveform	74
WG	26
Window	34
WMT	89
WMT Velocity Control	90
Write	
Patch	59
Performance	120
Rhythm Set	86
Sample	159
X	
XP-A-D	
Patch	39
Rhythm Set	52
Z	
Zoom Edit	
Patch	57
Rhythm Set	84
Zoom In	175
Zoom In/Out	148
Zoom Out	175



- UK** This symbol indicates that in EU countries, this product must be collected separately from household waste, as defined in each region. Products bearing this symbol must not be discarded together with household waste.
- DE** Dieses Symbol bedeutet, dass dieses Produkt in EU-Ländern getrennt vom Hausmüll gesammelt werden muss gemäß den regionalen Bestimmungen. Mit diesem Symbol gekennzeichnete Produkte dürfen nicht zusammen mit dem Hausmüll entsorgt werden.
- FR** Ce symbole indique que dans les pays de l'Union européenne, ce produit doit être collecté séparément des ordures ménagères selon les directives en vigueur dans chacun de ces pays. Les produits portant ce symbole ne doivent pas être mis au rebut avec les ordures ménagères.
- IT** Questo simbolo indica che nei paesi della Comunità europea questo prodotto deve essere smaltito separatamente dai normali rifiuti domestici, secondo la legislazione in vigore in ciascun paese. I prodotti che riportano questo simbolo non devono essere smaltiti insieme ai rifiuti domestici.
Ai sensi dell'art. 13 del D.Lgs. 25 luglio 2005 n. 151.
- ES** Este símbolo indica que en los países de la Unión Europea este producto debe recogerse aparte de los residuos domésticos, tal como esté regulado en cada zona. Los productos con este símbolo no se deben depositar con los residuos domésticos.
- PT** Este símbolo indica que nos países da UE, a recolha deste produto deverá ser feita separadamente do lixo doméstico, de acordo com os regulamentos de cada região. Os produtos que apresentem este símbolo não deverão ser eliminados juntamente com o lixo doméstico.
- NL** Dit symbool geeft aan dat in landen van de EU dit product gescheiden van huishoudelijk afval moet worden aangeboden, zoals bepaald per gemeente of regio. Producten die van dit symbool zijn voorzien, mogen niet samen met huishoudelijk afval worden verwijderd.
- DK** Dette symbol angiver, at i EU-lande skal dette produkt opsamles adskilt fra husholdningsaffald, som defineret i hver enkelt region. Produkter med dette symbol må ikke smides ud sammen med husholdningsaffald.
- NO** Dette symbolet indikerer at produktet må behandles som spesialavfall i EU-land, iht. til retningslinjer for den enkelte regionen, og ikke kastes sammen med vanlig husholdningsavfall. Produkter som er merket med dette symbolet, må ikke kastes sammen med vanlig husholdningsavfall.
- SE** Symbolen anger att i EU-länder måste den här produkten kasseras separat från hushållsavfall, i enlighet med varje regions bestämmelser. Produkter med den här symbolen får inte kasseras tillsammans med hushållsavfall.
- FI** Tämä merkintä ilmaisee, että tuote on EU-maissa kerättävä erillään kotitalousjätteistä kunkin alueen voimassa olevien määräysten mukaisesti. Tällä merkinnällä varustettuja tuotteita ei saa hävittää kotitalousjätteiden mukana.
- HU** Ez a szimbólum azt jelenti, hogy az Európai Unióban ezt a terméket a háztartási hulladéktól elkülönítve, az adott régióban érvényes szabályozás szerint kell gyűjtteni. Az ezzel a szimbóllal ellátott termékeket nem szabad a háztartási hulladék közé dobni.
- PL** Symbol oznacza, że zgodnie z regulacjami w odpowiednim regionie, w krajach UE produktu nie należy wyrzucać z odpadami domowymi. Produktów opatrzonych tym symbolem nie można utylizować razem z odpadami domowymi.
- CZ** Tento symbol udává, že v zemích EU musí být tento výrobek sbírán odděleně od domácího odpadu, jak je určeno pro každý region. Výrobky nesoucí tento symbol se nesmí vyhazovat spolu s domácím odpadem.
- SK** Tento symbol vyjadruje, že v krajinách EÚ sa musí zber tohto produktu vykonávať oddelene od domového odpadu, podľa nariadení platných v konkrétnej krajine. Produkty s týmto symbolom sa nesmú vyhazovať spolu s domovým odpadom.
- EE** See sümbol näitab, et EL-i maades tuleb see toode olemprügist eraldi koguda, nii nagu on igas piirkonnas määratletud. Selle sümboliga märgitud tooteid ei tohi ära visata koos olmeprügiga.
- LT** Šis simbolis rodo, kad ES šalyse šis produktas turi būti surenkamas atskirai nuo buitinių atliekų, kaip nustatyta kiekviename regione. Šiuo simboliu paženklinėti produktai neturi būti išmetami kartu su buitiniomis atliekomis.
- LV** Šis simbols norāda, ka ES valstīs šo produktu jāievāc atsevišķi no mājsaimniecības atkritumiem, kā noteikts katrā reģionā. Produkts ar šo simbolu nedrīkst izmest kopā ar mājsaimniecības atkritumiem.
- SI** Ta simbol označuje, da je treba proizvod v državah EU zbirati ločeno od gospodinjskih odpadkov, tako kot je določeno v vsaki regiji. Proizvoda s tem znakom ni dovoljeno odlagati skupaj z gospodinjskimi odpadki.
- GR** Βχφς φπ εμβπλπ δζλυνει ηφγ υφγτ χοςετ φζτ ΕΕ, φπ ρσπγν βχφς ρσΕρει ηβ υχλλΕγεφβγ οεχσςγυφβ βρυ φβ πγκγβκβ βρπσςЯммбфб, εμщцнб ме фз нпмпиеуЯб фзт КЪие ρсγпчЮт. Фб ρспγнфб рпх цЭспхн бхфς φπ εμβπλπ ден ρсЭрей ηб βρпсςЯрфпнфбγ мбжЯ ме фб πγκγбкβ βρпсςЯммбфб.

For the USA

DECLARATION OF CONFORMITY Compliance Information Statement

Model Name : Fantom-X6/X7/X8
Type of Equipment : Synthesizer Keyboard
Responsible Party : Roland Corporation U.S.
Address : 5100 S. Eastern Avenue, Los Angeles, CA 90040-2938
Telephone : (323) 890-3700

For EU Countries



This product complies with the requirements of European Directives EMC 89/336/EEC and LVD 73/23/EEC.

For the USA

FEDERAL COMMUNICATIONS COMMISSION RADIO FREQUENCY INTERFERENCE STATEMENT

This equipment has been tested and found to comply with the limits for a Class B digital device, pursuant to Part 15 of the FCC Rules. These limits are designed to provide reasonable protection against harmful interference in a residential installation. This equipment generates, uses, and can radiate radio frequency energy and, if not installed and used in accordance with the instructions, may cause harmful interference to radio communications. However, there is no guarantee that interference will not occur in a particular installation. If this equipment does cause harmful interference to radio or television reception, which can be determined by turning the equipment off and on, the user is encouraged to try to correct the interference by one or more of the following measures:

- Reorient or relocate the receiving antenna.
- Increase the separation between the equipment and receiver.
- Connect the equipment into an outlet on a circuit different from that to which the receiver is connected.
- Consult the dealer or an experienced radio/TV technician for help.

This device complies with Part 15 of the FCC Rules. Operation is subject to the following two conditions:

- (1) This device may not cause harmful interference, and
- (2) This device must accept any interference received, including interference that may cause undesired operation.

Tested To Comply With FCC Standards

FOR HOME OR OFFICE USE

Unauthorized changes or modification to this system can void the users authority to operate this equipment.
This equipment requires shielded interface cables in order to meet FCC class B Limit.

For Canada

NOTICE

This Class B digital apparatus meets all requirements of the Canadian Interference-Causing Equipment Regulations.

AVIS

Cet appareil numérique de la classe B respecte toutes les exigences du Règlement sur le matériel brouilleur du Canada.

Information

When you need repair service, call your nearest Roland Service Center or authorized Roland distributor in your country as shown below.

AFRICA

EGYPT

Al Fanny Trading Office
9, EBN Hagar A1 Askalany
Street,
ARD El Golf, Heliopolis,
Cairo 11341, EGYPT
TEL: 20-2-417-1828

REUNION

Maison FO - YAM Marcel
25 Rue Jules Hermann,
Chaudron - BP79 97 491
Ste Clotilde Cedex,
REUNION ISLAND
TEL: (0262) 218-429

SOUTH AFRICA

T.O.M.S. Sound & Music
(Pty)Ltd.
2 ASTRON ROAD DENVER
JOHANNESBURG ZA 2195,
SOUTH AFRICA
TEL: (011)417 3400
FAX: (011)417 3462

Paul Bothner(PTY)Ltd.
Royal Cape Park, Unit 24
Londonderry Road, Ottery 7800
Cape Town, SOUTH AFRICA
TEL: (021) 799 4900

ASIA

CHINA

Roland Shanghai Electronics
Co.,Ltd.
5F. No.1500 Pingliang Road
Shanghai 200090, CHINA
TEL: (021) 5580-0800

Roland Shanghai Electronics
Co.,Ltd.
(BEIJING OFFICE)
10F. No.18 3 Section Anhuaxili
Chaoyang District Beijing
100011 CHINA
TEL: (010) 6426-5050

HONG KONG

Tom Lee Music Co., Ltd.
Service Division
22-32 Pun Shan Street, Tsuen
Wan, New Territories,
HONG KONG
TEL: 2415 0911

Parsons Music Ltd.
8th Floor, Railway Plaza, 39
Chatham Road South, T.S.T.,
Kowloon, HONG KONG
TEL: 2333 1863

INDIA

Rivera Digitech (India) Pvt. Ltd.
409, Nirman Kendra
Mahalaxmi Flats Compound
Off. Dr. Edwin Moses Road,
Mumbai-400011, INDIA
TEL: (022) 2493 9051

INDONESIA

PT Citra IntiRama
Jl. Cideng Timur No. 15J-150
Jakarta Pusat
INDONESIA
TEL: (021) 6324170

KOREA

Cosmos Corporation
1461-9, Seocho-Dong,
Seocho Ku, Seoul, KOREA
TEL: (02) 3486-8855

MALAYSIA

Roland Asia Pacific Sdn. Bhd.
45-1, Block C2, Jalan PJU 1/39,
Dataran Prima, 47301 Petaling
Jaya, Selangor, MALAYSIA
TEL: (03) 7805-3263

PHILIPPINES

G.A. Yupangco & Co. Inc.
339 Gil J. Puyat Avenue
Makati, Metro Manila 1200,
PHILIPPINES
TEL: (02) 899 9801

SINGAPORE

SWEE LEE MUSIC
COMPANY PTE. LTD.
150 Sims Drive,
SINGAPORE 387381
TEL: 6846-3676

TAIWAN

ROLAND TAIWAN
ENTERPRISE CO., LTD.
Room 5, 9fl. No. 112 Chung
Shan N.Road Sec.2, Taipei,
TAIWAN, R.O.C.
TEL: (02) 2561 3339

THAILAND

Theera Music Co., Ltd.
330 Soi Verg NakhornKasem,
New Road, Sumpantawongse,
Bangkok 10100, THAILAND
TEL: (02) 224-8821

AUSTRALIA/ NEW ZEALAND

AUSTRALIA/
NEW ZEALAND
Roland Corporation
Australia Pty.,Ltd.
38 Campbell Avenue
Dee Why West. NSW 2099
AUSTRALIA

For Australia
Tel: (02) 9982 8266
For New Zealand
Tel: (09) 3098 715

CENTRAL/LATIN AMERICA

ARGENTINA
Instrumentos Musicales S.A.
Av.Santa Fe 2055
(1123) Buenos Aires
ARGENTINA
TEL: (011) 4508-2700

BARBADOS
A&B Music Supplies LTD
12 Webster Industrial Park
Wildye, St.Michael, Barbados
TEL: (246)430-1100

BRAZIL

Roland Brasil Ltda.
Rua San Jose, 780 Sala B
Parque Industrial San Jose
Cotia - Sao Paulo - SP, BRAZIL
TEL: (011) 4615 5666

CHILE

Comercial Fancy II S.A.
Rut.: 96.919.420-1
Natanuel Cox #739, 4th Floor
Santiago - Centro, CHILE
TEL: (02) 688-9540

COLOMBIA

Centro Musical Ltda.
Cra 43 B No 25 A 41 Bododega 9
Medellin, Colombia
TEL: (574)3812529

COSTA RICA

JUAN Bansbach Instrumentos
Musicales
Ave.1. Calle 11, Apartado
10237,
San Jose, COSTA RICA
TEL: 258-0211

CURACAO

Zeelandia Music Center Inc.
Orionweg 30
Curacao, Netherland Antilles
TEL:(305)5926866

DOMINICAN REPUBLIC

Instrumentos Fernando Giraldez
Calle Proyecto Central No.3
Ens.La Esperilla
Santo Domingo,
Dominican Republic
TEL:(809) 683 0305

ECUADOR

Mas Musica
Rumichaca 822 y Zaruma
Guayaquil - Ecuador
TEL:(593-4)2302364

EL SALVADOR

OMNI MUSIC
75 Avenida Norte y Final
Alameda Juan Pablo II,
Edificio No.4010 San Salvador,
EL SALVADOR
TEL: 262-0788

GUATEMALA

Casa Instrumental
Calzada Roosevelt 34-01.zona 11
Ciudad de Guatemala
Guatemala
TEL:(502) 599-2888

HONDURAS

Almacen Pajaro Azul S.A. de C.V.
BO.Paz Barahona
3 Ave.11 Calle S.O
San Pedro Sula, Honduras
TEL: (504) 553-2029

MARTINIQUE

Musique & Son
Z.I.Les Mangle
97232 Le Lamantin
Martinique F.W.I.
TEL: 596 596 426860

Gigamusic SARL
10 Rte De La Folie
97200 Fort De France
Martinique F.W.I.
TEL: 596 596 715222

MEXICO

Casa Veerkamp, s.a. de c.v.
Av. Toluca No. 323, Col. Olivar
de los Padres 01780 Mexico
D.F. MEXICO
TEL: (55) 5668-6699

NICARAGUA

Bansbach Instrumentos
Musicales Nicaragua
Altamira D'Este Calle Principal
de la Farmacia 5ta.Avenida
1 Cuadra al Lago.#503
Managua, Nicaragua
TEL: (505)277-2557

PANAMA

SUPRO MUNDIAL, S.A.
Boulevard Andrews, Albrook,
Panama City, REP. DE
PANAMA
TEL: 315-0101

PARAGUAY

Distribuidora De
Instrumentos Musicales
J.E. Olear y ESQ. Manduivira
Asuncion PARAGUAY
TEL: (595) 21 492147

PERU

Audionet
Distribuciones Musicales SAC
Juan Fanning 530
Miraflores
Lima - Peru
TEL: (511) 4461388

TRINIDAD

AMR Ltd
Ground Floor
Maritime Plaza
Barataria Trinidad W.I.
TEL: (868) 638 6385

URUGUAY

Todo Musica S.A.
Francisco Acuna de Figueroa
1771
C.P.: 11.800
Montevideo, URUGUAY
TEL: (02) 924-2335

VENEZUELA

Instrumentos Musicales
Allegro,C.A.
Av.las industrias edf.Guitar
import
#7 zona Industrial de Turumo
Caracas, Venezuela
TEL: (212) 244-1122

EUROPE

AUSTRIA

Roland Elektronische
Musikinstrumente HmbH.
Austrian Office
Eduard-Bodem-Gasse 8,
A-6020 Innsbruck, AUSTRIA
TEL: (0512) 26 44 260

BELGIUM/FRANCE/ HOLLAND/ LUXEMBOURG

Roland Central Europe N.V.
Houtstraat 3, B-2260, Oevel
(Westerlo) BELGIUM
TEL: (014) 575811

CROATIA

ART-CENTAR
Degenova 3.
HR - 10000 Zagreb
TEL: (1) 466 8493

CZECH REP.

CZECH REPUBLIC
DISTRIBUTOR s.r.o
Voctárova 247/16
CZ - 180 00 PRAHA 8,
CZECH REP.
TEL: (2) 830 20270

DENMARK

Roland Scandinavia A/S
Nordhavsvej 7, Postbox 880,
DK-2100 Copenhagen
DENMARK
TEL: 3916 6200

FINLAND

Roland Scandinavia As, Filial
Finland
Elannontie 5
FIN-01510 Vantaa, FINLAND
TEL: (09) 68 24 020

GERMANY

Roland Elektronische
Musikinstrumente HmbH.
Oststrasse 96, 22844
Norderstedt, GERMANY
TEL: (040) 52 60090

GREECE/CYPRUS

STOLLAS S.A.
Music Sound Light
155, New National Road
Patras 26442, GREECE
TEL: 2610 435400

HUNGARY

Roland East Europe Ltd.
Warehouse Area 'DEPO' Pf.83
H-2046 Torokbalint,
HUNGARY
TEL: (23) 511011

IRELAND

Roland Ireland
G2 Calmount Park, Calmount
Avenue, Dublin 12
Republic of IRELAND
TEL: (01) 4294444

ITALY

Roland Italy S. p. A.
Viale delle Industrie 8,
20020 Arese, Milano, ITALY
TEL: (02) 937-78300

NORWAY

Roland Scandinavia Avd.
Kontor Norge
Lilleakerveien 2 Postboks 95
Lilleaker N-0216 Oslo
NORWAY
TEL: 2273 0074

POLAND

ROLAND POLSKA SP. Z O.O.
UL. Gibraltarska 4.
PL-03 664 Warszawa
POLAND
TEL: (022) 679 4419

PORTUGAL

Roland Iberia, S.L.
Portugal Office
Cais das Pedras, 8/9-1 Dto
4050-465, Porto, PORTUGAL
TEL: 22 608 00 60

ROMANIA

FBS LINES
Piata Libertatii 1,
535500 Gheorgheni,
ROMANIA
TEL: (266) 364 609

RUSSIA

MuTek
Dorozhnaya ul.3,korp.6
117 545 Moscow, RUSSIA
TEL: (095) 981-4967

SLOVAKIA

DAN Acoustic s.r.o.
Povazská 18.
SK - 940 01 Nové Zámky
TEL: (035) 6424 330

SPAIN

Roland Iberia, S.L.
Paseo García Faria, 33-35
08005 Barcelona SPAIN
TEL: 93 493 91 00

SWEDEN

Roland Scandinavia A/S
SWEDISH SALES OFFICE
Danvik Center 28, 2 tr.
S-131 30 Nacka SWEDEN
TEL: (08) 702 00 20

SWITZERLAND

Roland (Switzerland) AG
Landstrasse 5, Postfach,
CH-4452 Itingen,
SWITZERLAND
TEL: (061) 927-8383

UKRAINE

EURHYTHMICS Ltd.
P.O.Box: 37-a.
Nedecey Str. 30
UA - 89600 Mukachevo,
UKRAINE
TEL: (03131) 414-40

UNITED KINGDOM

Roland (U.K.) Ltd.
Atlantic Close, Swansea
Enterprise Park, SWANSEA
SA7 9FJ,
UNITED KINGDOM
TEL: (01792) 702701

MIDDLE EAST

BAHRAIN

Moon Stores
No.16, Bab Al Bahrain Avenue,
P.O.Box 247, Manama 304,
State of BAHRAIN
TEL: 17 211 0015

IRAN

MOCO INC.
No.41 Nike St., Dr.Shariyati Ave.,
Roberoye Cerahe Mirdamad
Tehran, IRAN
TEL: (021) 285-4169

ISRAEL

Halilit P. Greenspoon & Sons
Ltd.
8 Retzif Ha'aliya Hashnya St.
Tel-Aviv-Yafo ISRAEL
TEL: (03) 6823666

JORDAN

MUSIC HOUSE CO. LTD.
FREDDY FOR MUSIC
P. O. Box 922846
Amman 11192 JORDAN
TEL: (06) 5692696

KUWAIT

EASA HUSAIN AL-YOUSIFI
& SONS CO.
Abdullah Salem Street,
Safat, KUWAIT
TEL: 243-6399

LEBANON

Chahine S.A.L.
Gerge Zeidan St., Chahine
Bldg., Achrafieh, P.O.Box: 16-
5857
Beirut, LEBANON
TEL: (01) 20-1441

OMAN

TALENTZ CENTRE L.L.C.
Malatan House No.1
Al Noor Street, Ruwi
SULTANATE OF OMAN
TEL: 2478 3443

QATAR

Al Emadi Co. (Badie Studio &
Stores)
P.O. Box 62, Doha, QATAR
TEL: 4423-554

SAUDI ARABIA

aDawiah Universal
Electronics APL
Corniche Road, Aldossary
Bldg., 1st Floor, Alkhobar,
SAUDI ARABIA

P.O.Box 2154, Alkhobar 31952
SAUDI ARABIA
TEL: (03) 898 2081

SYRIA

Technical Light & Sound
Center
Rawda, Abdul Qader Zajzari St.
Bldg. No. 21, P.O.BOX 13520,
Damascus, SYRIA
TEL: (011) 223-5384

TURKEY

ZUHAL DIS TICARET A.S.
Galip Dede Cad. No.37
Beyoglu - Istanbul / TURKEY
TEL: (0212) 249 85 10

U.A.E.

Zak Electronics & Musical
Instruments Co. L.L.C.
Zabeel Road, Al Sherouq Bldg.,
No. 14, Grand Floor, Dubai,
U.A.E.
TEL: (04) 3360715

NORTH AMERICA

CANADA

Roland Canada Ltd.
(Head Office)
5480 Parkwood Way
Richmond B. C., V6V 2M4
CANADA
TEL: (604) 270 6626

Roland Canada Ltd.

(Toronto Office)
170 Admiral Boulevard
Mississauga On L5T 2N6
CANADA
TEL: (905) 362 9707

U. S. A.

Roland Corporation U.S.
5100 S. Eastern Avenue
Los Angeles, CA 90040-2938,
U. S. A.
TEL: (323) 890 3700

As of November 1, 2006 (ROLAND)



0 3 5 6 9 9 0 1 - 1 0

03569901

07-04-AN